

# Distance *is* Safety®

WHAT STANDS BETWEEN YOU AND ARC-FLASH DANGER?

**WE DO.**



SCAN TO USE OUR  
POWERFUL ONLINE  
PRODUCT FINDER!





# CBS ArcSafe®

A Group CBS Company

**CBS ArcSafe®**, a Group CBS company, provides access to the industry's largest inventory of low- and medium-voltage switchgear remote systems for racking and switching operations. We have parts, on-site service, and comprehensive shop repair, remanufacturing, and life-extension capabilities.

**CBS ArcSafe** products allow technicians to remotely install and remove circuit breakers from a safe distance of up to 300 feet while stationed outside the arc-flash boundary.

## We take pride in being available and capable of responding anytime, anywhere.

- Group CBS affiliate companies are located across the U.S.
- Largest inventory of new, surplus, and reconditioned low- and medium-voltage power equipment and replacement parts available in North America
- Servicing of Class 1E nuclear-rated switchgear and circuit breakers (in compliance with 10CFR50 Appendix B)
- Modern shop facilities with skilled engineers and technicians
- Comprehensive quality repair, rebuild, retrofit, retrofill, and life-extension capabilities
- On-site scheduled or emergency field service
- Rentable equipment available
- Quick access to charter aircraft and hot-shot trucks for emergency requirements

**(877) 4-SAFETY (877) 472-3389**

2616 SIRIUS ROAD | DENTON, TX 76208

4782 CHIMNEY DRIVE | CHARLESTON, WV 25302

FX: 940-382-9435 | [INFO@CBSARCSAFE.COM](mailto:INFO@CBSARCSAFE.COM)

**CBS ArcSafe's personnel are available to assist you at any time. For after-hours or emergency support, contact us 24/7 via our emergency phone number: (940) 736-0800 or (940) 736-6641. Assistance is also available from other Group CBS companies, which are listed on the back cover. We continue to develop new solutions for our customers on a daily basis. If you do not see what you need in our catalog, give us a call.**

# CBS ArcSafe® Makes It Easy



## Our Most Powerful Solutions Guide, Ever!

This Arc Flash Solutions Guide makes finding the right product the first time easier than ever! It features more than 150 new product listings, photos of each type of equipment, manufacturer indexes for quick searches, and new for 2024: **QR codes that take you right to each product page.** With the addition of QR codes, detailed product information, videos, and our powerful Product Finder are at your fingertips.

Can't find what you need? Contact us today about custom solutions for your application.

**Large, easy-to-read descriptions** are available for each product, including manufacturers and equipment types.

**Detailed specifications** include compatibility information and control/power sources.

**Simple organization** by product category make product searches easy.

**Detailed photos** of our safety solutions and compatible equipment help you find the right part the first time.

**NEW! QR codes** take you right to our website to instantly learn more, see the solution in action, and request a quote.

**Click here!**



## Scan the QR to see the solution in action

Each product in this solutions guide includes a QR code that takes you right to a product page on the CBS ArcSafe website. There you will find operation and installation videos, additional information and specifications, datasheets, related products, and more! In this digital edition, all QR codes are clickable links.

## Finding the Solution You Need is Easy as 1, 2, 3

Make fast work of your searches with our powerful, easy-to-use **Online Product Finder**. Search hundreds of products by manufacturer, model, or series, and review circuit breaker photos to ensure you have the right solution for your equipment. The results link to product pages where you can get more information and request a quote.

1. Select a manufacturer.
2. Choose a model/series.
3. Review compatible circuit breaker photos.

Visit **CBSArcSafe.com** for comprehensive product specs, images, videos, and manuals. Find more than 20 award-winning products, and search over 700 products with a single click.

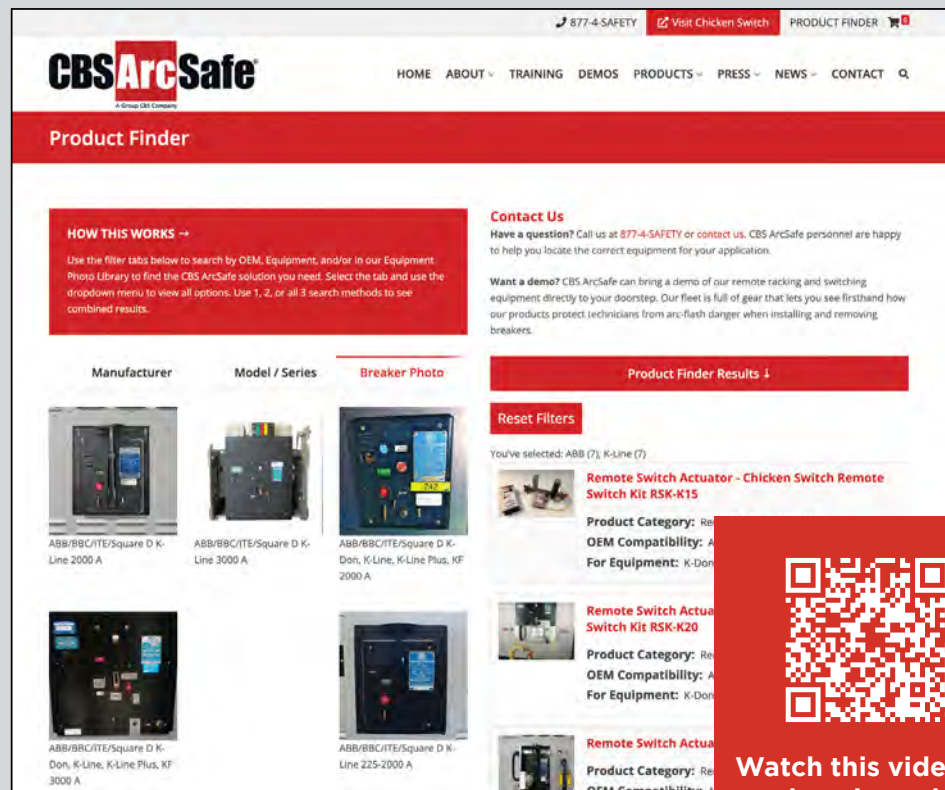

Watch this video to see how it works.



## Custom Solutions

Can't find what you're looking for? We'll work with you to develop custom remote racking and remote switching solutions to **safely operate your electrical equipment** outside the arc-flash boundary.



# Contents

**ROTARY REMOTE RACKING SYSTEMS..... 7**

RRS-1 ..... 8  
 RRS-1 LT..... 12  
 RRS-4..... 14

**EXTRACTOR REMOTE RACKING SYSTEMS ..... 21**

RRS-2 ..... 22  
 RRS-2 BE ..... 26

**APPARATUS-SPECIFIC PORTABLE  
 REMOTE RACKING SYSTEMS..... 30**

RRS-3 ..... 30  
 RRS-3 MANUFACTURER INDEX..... 32  
 RRS-3 PRODUCT INDEX ..... 34

**REMOTE SWITCH OPERATORS (RSOs) ..... 62**

**REMOTE SWITCH ACTUATORS (RSAs) ..... 64**

RSA/RSK MANUFACTURER INDEX ..... 65  
 RSA/RSK PRODUCT INDEX ..... 72

**REMOTE SWITCH KITS (RSKs) .....230**



**RRS-3 MB II**



**RRS-3 VB**



**RRS-3 DSR1**



**RSO-IV-M18**



# Remote Racking Systems

## For Rotary-Type Equipment

**RRS®-1**

**RRS®-1 LT**

**RRS®-4**



Compatible with all switchgear manufacturers, including:

- |                  |                            |                    |                      |
|------------------|----------------------------|--------------------|----------------------|
| ■ ABB            | ■ Controlled Power         | ■ General Electric | ■ Reyrolle           |
| ■ AEG            | ■ Cutler-Hammer            | ■ Hyundai          | ■ Schneider Electric |
| ■ Allis-Chalmers | ■ Eaton                    | ■ ITE              | ■ Siemens            |
| ■ Alstom         | ■ Federal Pacific Electric | ■ McGraw-Edison    | ■ Siemens-Allis      |
| ■ Areva          | ■ Federal Pioneer          | ■ Merlin Gerin     | ■ Square D           |
| ■ Asea           | ■ Fuji                     | ■ Mitsubishi       | ■ Toshiba            |
| ■ BBC            | ■ GEC                      | ■ Powell           | ■ Westinghouse       |

NOTE: All manufacturers' names, trademarks, and part numbers are used for reference purposes only. CBS ArcSafe, Inc., is not an authorized distributor or representative of manufacturers shown. Designated trademarks, brand names, and brands appearing herein are the property of their respective owners.

# RRS-1 Remote Racking System

## For Rotary Circuit Breakers



By permitting the automatic racking of the circuit breaker from a remote location, the **CBS ArcSafe**® remote racking system replaces the manual racking operation and removes the operating personnel from manual contact with the circuit breaker. The unique design of the **CBS ArcSafe** remote racking system, with its specially manufactured drive shafts and tooling, enables the system to operate with all types of circuit breakers produced by major switchgear manufacturers. The **CBS ArcSafe** remote racking system can operate with draw-out types of air, SF6, oil, and vacuum circuit breakers that have either a horizontal or vertical racking operation.

### BENEFITS

- Remote operation places operator outside the arc-flash protection boundary.
- Compatible with low- and medium-voltage circuit breakers produced by all major switchgear manufacturers.
- Use with horizontal and vertical types of air, SF6, oil, and vacuum circuit breakers.
- Height and angle of the drive are easily adjusted.
- Quick-release drive shafts and couplings simplify setup.
- Redundant over-racking protection provided.
- Seamless transfer of AC/DC power.
- Hand-truck design provides easy mobility.



A) Westinghouse/Cutler-Hammer/Eaton/Square D  
B) GE: AKD-5 (AK)  
C) GE: Magne-Blast

### Current Control Module

CCMs ship with all RRS units and provide directional, timing, and current control in addition to other helpful features. For more information, see page 20.



US PATENT NO. 8,151,452B2

**SPECIFICATIONS**

- WEIGHT . . .** 180 lbs.
- BATTERY LIFE . . .** >50 operations\*
- SYSTEM VOLTAGE . . .** 24 V DC
- INPUT VOLTAGE . . .** 120 ±10% V AC, 47-63 Hz†
- MAXIMUM AC CURRENT . . .** 12.2 A
- DRIVE MOTOR POWER . . .** 250 W
- DRIVE ASSEMBLY SPEED . . .** 80 RPM
- CHARGE TIME . . .** Approx. 6 hours
- DIMENSIONS . . .** 74" H x 26" W x 38.1" D
- OPERATING DISTANCE . . .** 35 ft.‡

\*Number of operations is dependent on the nature of the operation  
 †May be custom ordered to match different local power standards  
 ‡Standard configuration; contact CBS ArcSafe for other options



**TOOLING COMPATIBILITY**

The RRS-1 is compatible with the following circuit breaker models:\*

ABB-AmVac	Asea-MV	General Electric-Magne-blast	Reyrolle-LMT2
ABB-AdVac	Brusk-VSI	General Electric-Magne-blast (Canadian)	Schneider Electric/Square D-Evolis
ABB-HD4	Controlled Power-HVF	General Electric-PowerBreak	Schneider Electric/Square D-LF
ABB-HPA	Cutler-Hammer/Eaton-Magnum DS	General Electric-PowerBreak II	Schneider Electric/Square D-Masterpact NT
ABB-VD4	Cutler-Hammer/Eaton/Square D/	General Electric-PowerVac	Schneider Electric/Square D-Masterpact NW
ABB-Vmax	Westinghouse-DS	General Electric-WavePro	Siemens-3AF
ABB/BBC/ITE-38 HKV	Cutler-Hammer/Eaton/Square D/	Hawker-D8XE	Siemens-81000
ABB/BBC/ITE-GHK	Westinghouse-DSL	Hawker-HG12	Siemens-8BK20
ABB/BBC/ITE-HK	Cutler-Hammer/Eaton/Square D/	Hitachi-AK	Siemens-8BKE
ABB/BBC/ITE-HK-1000	Westinghouse-DSII	Howe-Yin-HVC	Siemens-GMI
ABB/BBC/ITE-HK-Line	Cutler-Hammer/Eaton/	Howe-Yin-HVD	Siemens-NX-Air
ABB/BBC/ITE-K-Line	Westinghouse-VCP-W	ITE-K Series	Siemens-Simoprime
ABB/BBC/ITE-LK	Cutler-Hammer/Westinghouse-SPB	Konkar-VK	Square D-VR
ABB/BBC/ITE-MB	Cutler-Hammer/Westinghouse-VCP	Larson & Toubro-TF	Siemens-WL
ABB/BBC/ITE-SBKJ	Cutler-Hammer/Westinghouse-VCP-T	McGraw Edison-PSD	Siemens/Siemens-Allis-RL
ABB/BBC/ITE-VHK	Efacec-QBN7	McGraw Edison-WS	Siemens/Siemens-Allis-VV
ABB/BBC/ITE-VKB	FPE-DST	McGraw Edison-WSA	Square D-SE
ABB/BBC/ITE-HV	FPE-FMS-4	Merlin Gerin-DA	Square D-VAD-1
ABB/Sace-Emax	FPE-FPS-4	Merlin Gerin-FG2	Square D-VAD-2
ABB/Sace-Isomax	FPE-H Series	Merlin Gerin-LF2	Square D-VAD-3
ABB/Sace-Megamax	Fuji-Type T	Merlin Gerin-LF2	Sylvania-SSPB
ABB/Sace-Tmax	Fuji-VCB	Merlin Gerin-Masterpact MP	Terasaki-AT
Allis-Chalmers-AM	GEC-VMX	Merlin Gerin-Selpact	Toprank-HV12
Allis-Chalmers-Ruptair	General Electric-AK	Mitsubishi-DHP	Toshiba-VK
Allis-Chalmers/Siemens-Allis-FCV	General Electric-AKR	Mitsubishi-HC-Z	Westinghouse-B28B
Allis-Chalmers/Siemens-Allis-G Series	General Electric-AMH	Mitsubishi-VPR	Westinghouse-DB
Allis-Chalmers/Siemens-Allis-LA	General Electric-AMH (34.5KV)	Mitsubishi-WS	Westinghouse-DH
Alstom-HVX	General Electric-EntelliGuard	Nuova Magrini Galileo-B -Control	Westinghouse-DHP
Alstom-HWX	General Electric-EntelliGuard G	Powell-PowlVac	
Alstom/GEC-SBV	General Electric-FK	Power Solutions-BV	
Areva-HVX		Reyrolle-LMT	

\*Developed tooling listed; CBS ArcSafe can also develop new tooling for customers.

# RRS-1

## Guide to the RRS-1 Universal Rotary Remote Racking System

- 1 Height Adjustment Handle
- 2 CCM Status Indicator Light
- 3 Storage Bag
- 4 Drive Motor
- 5 Drive Motor Gearbox
- 6 CCM Status Indicator Siren
- 7 AC Power Input Receptacle
- 8 Wired Pendant Station
- 9 Main Power Disconnect
- 10 Floor Lock
- 11 Frame
- 12 Wired Pendant Coil Cord
- 13 Current Control Module (CCM)
- 14 Control Cabinet
- 15 Power Supply
- 16 Slide Rail
- 17 Drive Motor Brake
- 18 Torque Limiter Assembly
- 19 Spring-Loaded Drive Head
- 20 Front Wheels
- 21 Rear Wheels

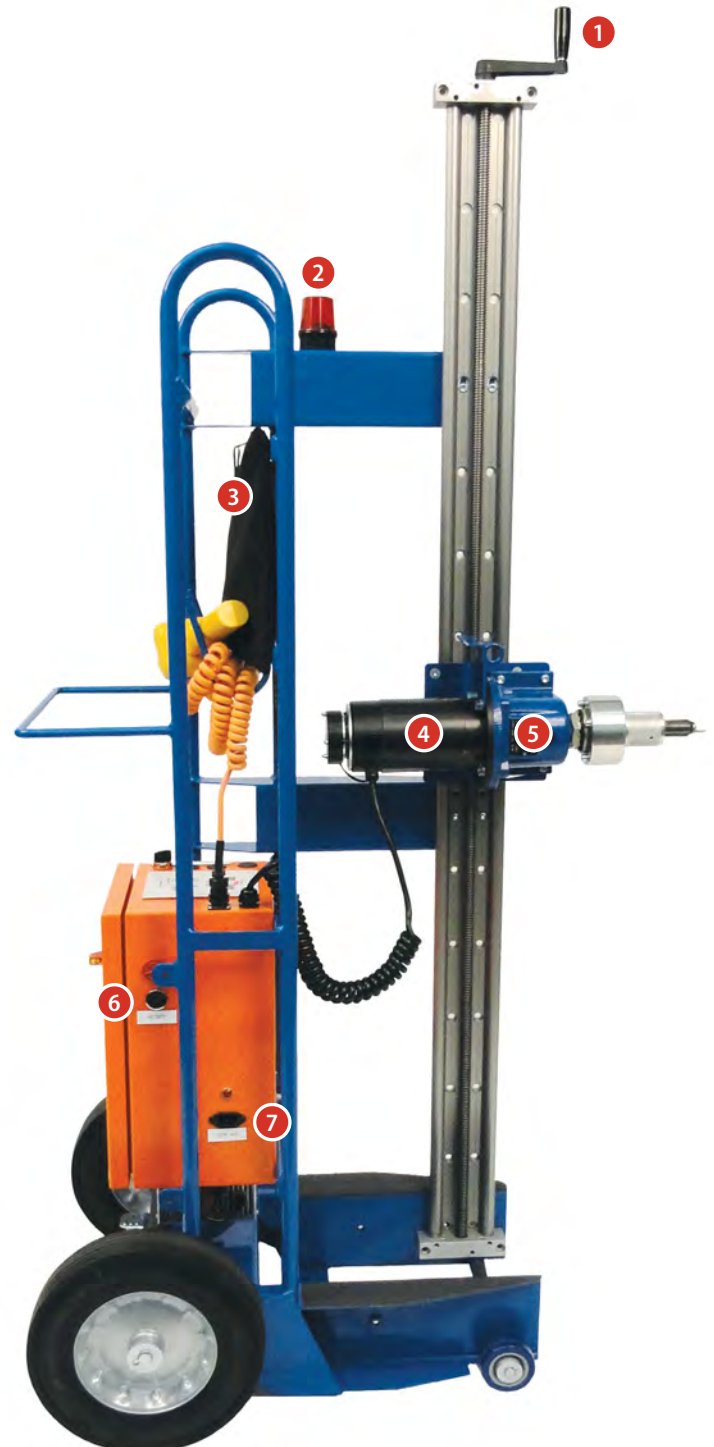

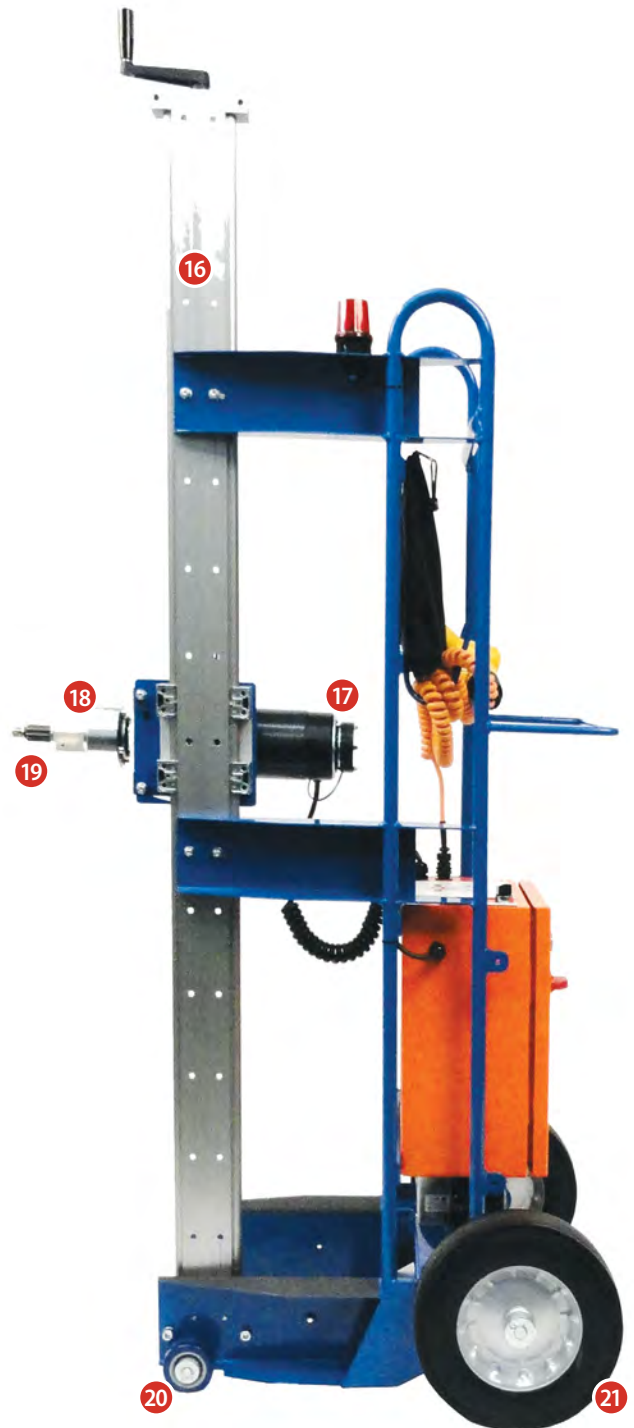

# RRS-1 LT **Lightweight Rotary Remote Racking System**



The RRS-1 LT system is **CBS ArcSafe's** lightweight and compact counterpart to the industry-leading RRS-1 universal rotary remote racking system. The RRS-1 LT is designed specifically for applications and environments where a weight and/or size constraint may limit the use of the RRS-1. To meet the design requirements for the RRS-1 LT, **CBS ArcSafe** had to minimize the size and weight of the unit, therefore decreasing the rating. **CBS ArcSafe** recommends using the RRS-1 LT primarily on low-voltage circuit breakers requiring no more than 20 lb.-ft. of racking torque.

## BENEFITS

- **The original RRS-1 unit has been redesigned to create the RRS-1 LT, which reduces the overall size and weight.**
- Ideal for applications where users must transport racking unit by themselves through tight spaces or up stairways.
- Utilizes same dual-redundant racking protection via the Current Control Module (CCM) and mechanical torque limiter, giving users two means of protection against damaging equipment during racking operations.
- Welded steel frame of the RRS-1 has been replaced with a lightweight extruded aluminum frame that supports customization based on specific application requirements.
- Large drive motor has been upgraded to a compact, brushless DC gear motor assembly.
- Height adjustment rail on the RRS-1 has been replaced with a lightweight, manually operated quick-release slide assembly.
- Control cabinet housing all electronics vital for operation has been integrated into a separate rugged case for simple transportation and storage.
- Large rubber wheels have been upgraded with a smaller and lighter replacement.
- Intelligent DC power system allows the unit to run on battery power. AC power is possible if using legacy RSO-IV.
- Two-station high-reach vertical adjustment capable of reaching breaker racking mechanisms up to 80" high. Also included is a wireless remote control that allows users to operate the unit from up to 300 ft. away.

## SPECIFICATIONS

- WEIGHT** . . . 135 lbs.
- BATTERY LIFE** . . . >50 operations\*
- SYSTEM VOLTAGE** . . . 18 V DC
- CHARGER VOLTAGE** . . . 120 ±10% V AC, 47-63 Hz<sup>†</sup>
- PERMISSABLE TORQUE** . . . 20 lb.-ft.
- DRIVE MOTOR POWER** . . . 200 W
- DRIVE ASSEMBLY SPEED** . . . 60 RPM
- CHARGE TIME** . . . Under 60 minutes
- DIMENSIONS** . . . 60" H x 22" W x 27" D
- OPERATING DISTANCE** . . . 300 ft.<sup>‡</sup>

\*Number of operations is dependent on the nature of the operation  
<sup>†</sup>May be custom ordered to match different local power standards  
<sup>‡</sup>Radio remote control standard on RRS-1 LT

## Current Control Module

CCMs ship with all RRS units and provide directional, timing, and current control in addition to other helpful features. For more information, see page 20.



- 1 Aluminum Frame
- 2 Transport Handle
- 3 Main Disconnect
- 4 Current Control Module (CCM)
- 5 RSO-IV LT Controller (Legacy Operator Shown)
- 6 AC/DC Power Supply
- 7 Floor Lock
- 8 Rear Wheels
- 9 Slide Rail
- 10 Motor Drive Controller
- 11 Spring-Loaded Drive Head
- 12 Torque Limiter Assembly
- 13 Tether Hooks
- 14 Drive Motor
- 15 Height Adjust Handles
- 16 Front Wheels



See tooling list on page 9 for compatible equipment.  
Not all tooling available for RRS-1 LT.

Model shown with legacy RSO-IV control power source  
installed.



# RRS-4 Remote Racking System

## With Smart Rack Technology



The RRS-4 boasts many of the same structural and mechanical components as the **CBS ArcSafe** RRS-1 unit, making the RRS-4 unit the most portable, easily adjustable, and user-friendly racking system that uses sequential turn-count technology in the industry today.

**What makes the RRS-4 different from its RRS-1 counterpart, and any other remote racking system on the market, is its dual-mode, source-programmable controller.**

### OPERATING MODES

The current control monitoring (CCM) mode is a truly universal operating mode capable of racking virtually any rotary-style breaker and requires minimal setup. In SEK mode, users create a custom profile that includes real-time breaker location feedback for each breaker style being operated. Both modes are considered source programmable — all setup and operation can be done in the field without factory assistance by following the setup procedures detailed in the manual.

The RRS-4 is powered via standard 120 V AC wall power or the internal batteries (which provide approximately 30-60 racking operations depending on the application) when wall power is not available. The RRS-4 comes standard with a corded 35-foot pendant station (extended lengths available) and a wireless radio remote pendant station capable of operating the unit from over 300 feet away.



### BENEFITS

- Two operating modes:
  - CCM Mode:** Current control monitoring mode
  - SEK Mode:** Turn-counting mode
- Real-time breaker location feedback in SEK mode.
- AC/DC power system.
- Source programmable — all setup and operation can be done in the field without factory assistance.
- Hand-truck design provides easy mobility.
- Status indicator lets the operator know when racking is complete.
- Dual-redundant racking protection offered.

**SPECIFICATIONS**

- WEIGHT . . .** 200 lbs.
- BATTERY LIFE . . .** >50 operations\*
- SYSTEM VOLTAGE . . .** 24 V DC
- INPUT VOLTAGE . . .** 120 ±10% V AC, 47-63 Hz†
- MAXIMUM AC CURRENT . . .** 12.2 A
- DRIVE MOTOR POWER . . .** 250 W
- DRIVE ASSEMBLY SPEED . . .** Variable: 60/80 RPM
- CHARGE TIME . . .** Approx. 6 hours
- DIMENSIONS . . .** 74" H x 26" W x 38.1" D
- OPERATING DISTANCE . . .** 35 ft. wired; 300 ft. wireless‡

\*Number of operations is dependent on the nature of the operation  
 †May be custom ordered to match different local power standards  
 ‡Standard configuration; contact CBS ArcSafe® for other options



A) Westinghouse/Cutler-Hammer/Eaton/Square D  
 B) GE: AKD-5 (AK)  
 C) GE: Magne-Blast

**TOOLING COMPATIBILITY**

The RRS-4 is compatible with the following circuit breaker models:

ABB-AmVac	Areva-HVX	General Electric-PowerBreak	Schneider Electric/Square D-Evolis
ABB-AdVac	Asea-MV	General Electric-PowerBreak II	Schneider Electric/Square D-LF
ABB-HD4	Brusk-VSI	General Electric-PowerVac	Schneider Electric/Square D-Masterpact NT
ABB-HPA	Controlled Power-HVF	General Electric-WavePro	Schneider Electric/Square D-Masterpact NW
ABB-VD4	Cutler-Hammer/Eaton-Magnum DS	Hawker-D8XE	Siemens-3AF
ABB-Vmax	Cutler-Hammer/Eaton/Square D/Westinghouse-DS	Hawker-HG12	Siemens-81000
ABB/BBC/ITE-38 HKV	Cutler-Hammer/Eaton/Square D/Westinghouse-DSL	Hitachi-AK	Siemens-8BK20
ABB/BBC/ITE-GHK	Cutler-Hammer/Eaton/Square D/Westinghouse-DSII	Howe-Yin-HVC	Siemens-8BKE
ABB/BBC/ITE-HK	Cutler-Hammer/Eaton/Westinghouse-VCP-W	Howe-Yin-HVD	Siemens-GMI
ABB/BBC/ITE-HK-1000	Cutler-Hammer/Westinghouse-SPB	ITE-K Series	Siemens-NX-Air
ABB/BBC/ITE-K-Line	Cutler-Hammer/Westinghouse-VCP	Konkar-VK	Siemens-Simoprime
ABB/BBC/ITE-LK	Cutler-Hammer/Westinghouse-VCP-T	Larson & Toubro-TF	Square D-VR
ABB/BBC/ITE-MB	Efacec-QBN7	McGraw Edison-PSD	Siemens-WL
ABB/BBC/ITE-SBKJ	FPE-DST	McGraw Edison-WS	Siemens/Siemens-Allis-RL
ABB/BBC/ITE-VHK	FPE-FMS-4	McGraw Edison-WSA	Siemens/Siemens-Allis-VV
ABB/BBC/ITE-VKB	FPE-FPS-4	Merlin Gerin-DA	Square D-SE
ABB/BBC/ITE-HV	FPE-H Series	Merlin Gerin-FG2	Square D-VAD-1
ABB/Sace-Emax	Fuji-Type T	Merlin Gerin-LF2	Square D-VAD-2
ABB/Sace-Isomax	Fuji-VCB	Merlin Gerin-Masterpact MP	Square D-VAD-3
ABB/Sace-Megamax	GEC-VMX	Merlin Gerin-Selpact	Sylvania-SSPB
ABB/Sace-Tmax	General Electric-AK	Mitsubishi-DHP	Terasaki-AT
Allis-Chalmers-AM	General Electric-AKR	Mitsubishi-HC-Z	Toprank-HV12
Allis-Chalmers-Ruptair	General Electric-AMH	Mitsubishi-VPR	Toshiba-VK
Allis-Chalmers/Siemens-Allis-FCV	General Electric-AMH (34.5kV)	Mitsubishi-WS	Westinghouse-B28B
Allis-Chalmers/Siemens-Allis-G Series	General Electric-EntelliGuard	Nuova Magrini Galileo-B-Control	Westinghouse-DB
Allis-Chalmers/Siemens-Allis-LA	General Electric-EntelliGuard G	Powell-PowIVac	Westinghouse-DH
Alstom-HVX	General Electric-FK	Power Solutions-BV	Westinghouse-DHP
Alstom-HWX	General Electric-Magne-blast	Reyrolle-LMT	
Alstom/GEC-SBV	General Electric-Magne-blast (Canadian)	Reyrolle-LMT2	

\*Developed tooling listed; CBS ArcSafe can also develop new tooling for customers.

# RRS-4

## Guide to the RRS-4 Universal Rotary Remote Racking System

- 1 Height Adjustment Handle
- 2 CCM Status Indicator Light
- 3 Drive Motor Gearbox
- 4 Drive Motor
- 5 Wired Pendant Station
- 6 CCM Status Indicator Siren
- 7 AC Power Input Receptacle
- 8 Battery Indicator
- 9 Frame
- 10 Storage Bag
- 11 Control Cabinet
- 12 PD Alert (Partial Discharge Sensor)
- 13 Power Supply
- 14 Slide Rail
- 15 Torque Limiter Assembly
- 16 Drive Encoder
- 17 Drive Motor Brake
- 18 Wireless Pendant Station
- 19 User Interface
- 20 Main Disconnect
- 21 Front Wheels
- 22 Rear Wheels



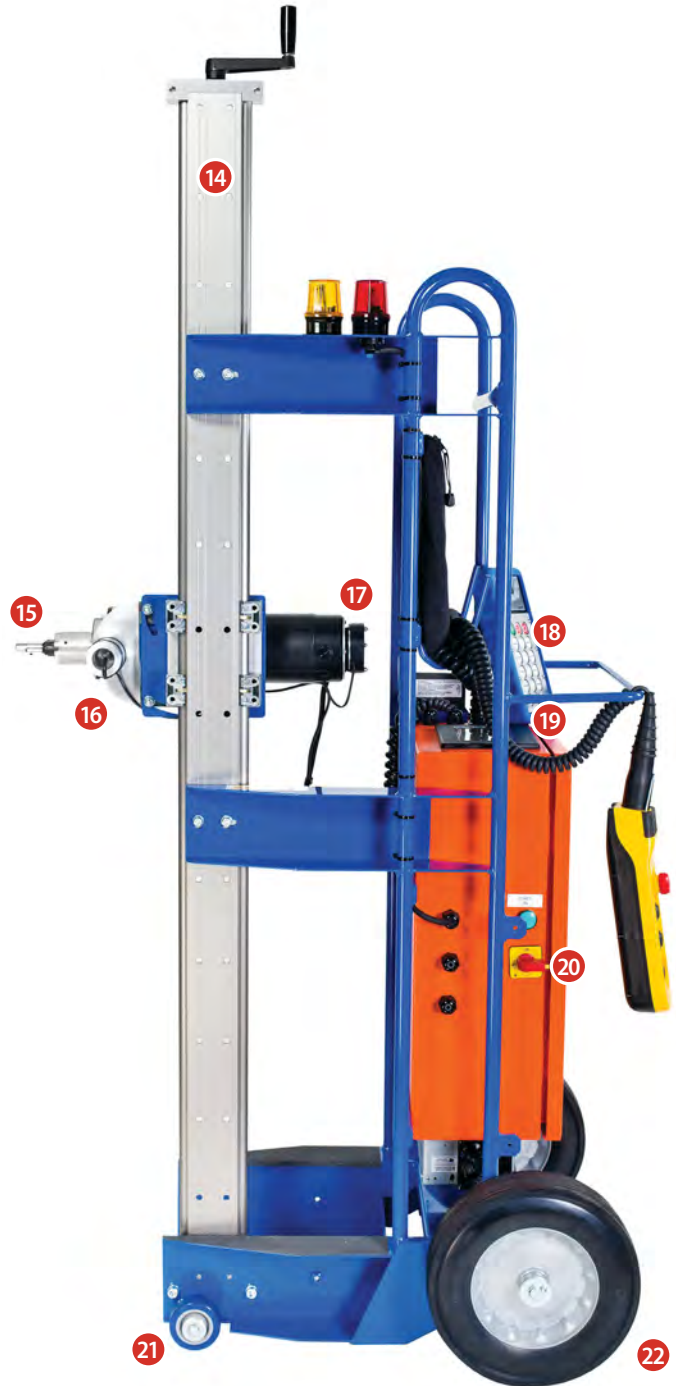

# RRS-1 RRS-4

## Available Options

Some options not available for use with RRS-1 LT. Contact CBS ArcSafe for details.

### CCM Radio Remote

The CCM radio remote option allows users to operate the RRS and monitor the racking status wirelessly from up to 300 ft. away. Ideal for users with extended distance requirements or those who wish to remotely monitor the status of the racking operation.



### Wireless/Wired Video System

The wireless/wired video system allows users to monitor the remote racking operation from up to 300 ft. away using an RRS-mounted camera and stand-alone monitor. Ideal for users who will be visually separated from the RRS during the remote operation.

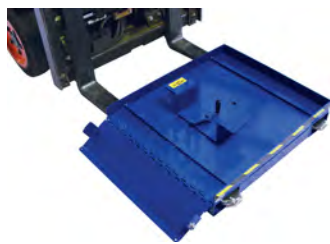

### Transport Skid

The transport skid features a built-in ramp for loading and unloading integrated spring-loaded latches to secure the ramp when not in use. Ideal for transporting equipment to remote or difficult-to-access locations.



### LED Light

The LED light accessory adds a forward-facing, high-intensity light source with pan-and-tilt capability to the front of the RRS. Ideal for setting up the RRS or installing RRS tooling in low-light environments.

### Water-Resistant Cover

It is recommended that the RRS be stored in a dry, temperature-controlled environment. Because this is not always possible, CBS ArcSafe offers a water-resistant cover that protects the RRS from contact with small amounts of liquid.



### Pneumatic Tires

The air-filled pneumatic tires provide a cushioning effect and reduce wear on the RRS unit during transport. Ideal for customer applications where transportation or use on uneven, rocky, or gravel surfaces is likely to occur.

### Wired Pendant Extensions

The wired pendant extension(s) allows users to operate the RRS from extended distances while remaining tethered to the unit. Ideal for use in facilities with extended distance requirements that also restrict radio-controlled device transmission.



### Stair Climber Rails

The stair climber rails provide a low-friction surface for use when transporting the RRS up and down stairs and offer a level of protection to the control cabinet during everyday use. Ideal for applications requiring transportation up or down stairways.

**RRS-1** **RRS-4**

**Available Options**

Some options not available for use with RRS-1 LT. Contact CBS ArcSafe for details.

**Power Slide**

The power slide system utilizes a motor instead of the standard handle to raise and lower the drive assembly. Ideal for applications requiring users to quickly and easily switch between racking heights for different breakers.



**High Lift**

The high-lift option is required to remotely rack any equipment with a racking mechanism more than 66 inches off the ground. Ideal for users who wish to rack breakers with extremely high racking mechanisms that would otherwise cause issues during manual operation.



**Magne-Blast Supervisory Link**

The MBSL allows RRS to interface with the pre-existing control circuit and cubicle-mounted limit switches within GE Magne-Blast gear. Ideal for users who want to control the RRS by utilizing the pre-existing Magne-Blast control scheme.



**Tether System**

The tether kit provides a universal link between the RRS and the electrical equipment being remotely racked. Ideal for users who wish to remotely rack breakers with moving racking mechanisms.



**Low-Speed/Jog**

The low-speed/jog option consists of a high-torque/low-speed gearbox, as well as manual jog control for the RRS operation. Ideal for applications requiring added torque output and/or more precise control.



**Front Casters**

The front casters allow for maximum mobility even in the tightest spaces, simplifying installation and setup in these locations. Ideal for tight or constrained areas where users may otherwise have difficulty maneuvering the RRS.



Partial Discharge: The First Line of Defense



**PD Alert Sensor**

PD Alert provides an additional layer of safety for technicians tasked with racking or removing circuit breakers and motor control centers. In the event of a breakdown in line-to-line or line-to-ground insulation, the programmable PD Alert radio frequency (RF) noncontact sensor issues a visual strobe alarm or digital alarm via email or SMS text message. Compatible with RRS-1, RRS-1 LT, RRS-4, and RRS-2 only; also works as stand-alone sensor.



# Current Control Module

## Current Control Module

The Current Control Module (CCM) gives the operator more control over the remote racking operation, including direction, manual and automation operation, and current control and current recording. High-current demands can indicate mechanical problems, including the need for lubrication.

### Features for all RRS units:

- Indicator shows low power.
- Install and remove directional control (some switchgear use counterclockwise for install and clockwise for remove).
- Manual current control allows the operator to both monitor and record the current draw during the racking operation.
- Simple to change to/from manual and to/from automatic operation.
- Maximum current operation records the highest current reached during the racking operation.
- Adjustable time-stop parameter allows the current to spike briefly without stopping the racking procedure. For instance, some breakers may have a small increase in resistance while being racked because they are not well lubricated.

### Additional features for the RRS-1:

- Ability to work with any control voltage when equipped with the Magne-Blast Supervisory Link, eliminating the need to change relays for different control voltages.
- Gives location feedback when operating Magne-Blast Supervisory Link by displaying dots on the screen for the fully installed and removed positions.
- Built-in coast-down timers for Magne-Blast Supervisory Link operation, which can be adjusted from the CCM itself.
- Automatically reverses motor rotation for use with the geared adapter when the machine is working in supervisory link mode on Magne-Blast circuit breakers.
- Built-in jog timers for machines equipped with the low-speed/jog function, which can be adjusted from the CCM itself.



# Remote Racking Systems

## For Extractor-Type Equipment

**RRS®-2**



**RRS®-2 BE**



Compatible with all switchgear manufacturers, including:

- |                  |                            |                    |                      |
|------------------|----------------------------|--------------------|----------------------|
| ■ ABB            | ■ Controlled Power         | ■ General Electric | ■ Reyrolle           |
| ■ AEG            | ■ Cutler-Hammer            | ■ Hyundai          | ■ Schneider Electric |
| ■ Allis-Chalmers | ■ Eaton                    | ■ ITE              | ■ Siemens            |
| ■ Alstom         | ■ Federal Pacific Electric | ■ McGraw-Edison    | ■ Siemens-Allis      |
| ■ Areva          | ■ Federal Pioneer          | ■ Merlin Gerin     | ■ Square D           |
| ■ Asea           | ■ Fuji                     | ■ Mitsubishi       | ■ Toshiba            |
| ■ BBC            | ■ GEC                      | ■ Powell           | ■ Westinghouse       |

NOTE: All manufacturers' names, trademarks, and part numbers are used for reference purposes only. CBS ArcSafe, Inc., is not an authorized distributor or representative of manufacturers shown. Designated trademarks, brand names, and brands appearing herein are the property of their respective owners.

# RRS-2 Remote Racking System

## For Extraction-Style Circuit Breakers



The CBS ArcSafe RRS-2 is a portable and highly configurable remote racking system built to rack all circuit breakers with non-rotary racking mechanisms while keeping the operator outside of the arc-flash boundary. The operator is able to manipulate the breaker-specific tooling, available for numerous makes and models of switchgear, via a wired or wireless pendant station from up to 300 ft. away. The RRS-2 is powered by a redundant AC/DC system that utilizes either standard AC power or the internal battery to run the unit. Absolutely no modifications to the switchgear or circuit breaker are necessary to perform remote racking with the RRS-2. Prior to ordering, CBS ArcSafe recommends on-site evaluation by a company representative to ensure the proper equipment is provided for each customer based on their particular switchgear and specific requests.



US PATENT 8,063,323 B1

### Current Control Module

CCMs ship with all RRS units and provide directional, timing, and current control in addition to other helpful features. For more information, see page 20.



## BENEFITS

- Remote operation places operator outside the arc-flash protection boundary.
- Use with low- and medium-voltage circuit breakers produced by all the major switchgear manufacturers.
- Use with many lever-actuated racking switchgear models that do not utilize rotary racking mechanisms.
- Easily adjust actuator height.
- Quick-connect and -release drive actuators simplify setup.
- Redundant AC/DC power.
- Hand-truck design provides easy mobility.

## TOOLING COMPATIBILITY

The RRS-2 is compatible with the following circuit breaker models:

ABB- RMMVAC (FC & FS Replacement)  
 Allis Chalmers, Siemens Allis, Siemens - FA & FC(V)-350, 500, 750, 1000-A(-1) & B  
 Allis Chalmers, Siemens Allis, Siemens - FA, FB, FC-250, 350, 500, 750, 1000  
 Allis Chalmers, Siemens Allis, Siemens - MA-150, 250, 350  
 Allis Chalmers, Siemens Allis, Siemens - MA-150, 250, 350A(-1)  
 Allis Chalmers, Siemens Allis, Siemens - MA-150, 250, 350B(-1)  
 Allis Chalmers, Siemens Allis, Siemens - MA-150, 250, 350C(-1)  
 Allis Chalmers, Siemens Allis, Siemens - MA-75A  
 Controlled Power - 38kV  
 Eaton - DST-2-VR  
 EPE - VFT-12  
 FPE - DST-2 (5-15kV, 1200-3000A, 75-750MVA)  
 FPE - DST-2 (15kV, 3000A, 1000MVA)  
 General Electric - AK-1/2-50/75  
 General Electric - AK-1/2-50/75 (Nelson)  
 General Electric - AK-1-25  
 General Electric - AK-2-25  
 General Electric - AK-2-25 (Nelson)  
 General Electric - AL  
 ITE - HV (15kV)  
 Merlin Gerin - FG-2  
 Merlin Gerin - Fluarc FG-1  
 Sace Bergamo - DR (5-15kV, 1200-3000A, 75-750MVA)  
 Sace Bergamo - DR (15kV, 3000A, 1000MVA)  
 Siemens - 8BD1  
 Siemens - FSV  
 Siemens - MSV  
 Tamco - VK  
 Westinghouse - DA-50  
 Westinghouse - DA-75  
 Westinghouse - DB-15  
 Westinghouse - DB-25  
 Westinghouse - DB-50

\*Developed tooling listed; CBS ArcSafe can also develop new tooling for customers.

## SPECIFICATIONS

- WEIGHT** . . . 160 lbs.
- BATTERY LIFE** . . . >50 operations\*
- SYSTEM VOLTAGE** . . . 24 V DC
- INPUT VOLTAGE** . . . 120 ±10% V AC, 47-63 Hz<sup>†</sup>
- MAXIMUM AC CURRENT** . . . 12.2 A
- EXT. ACTUATOR FORCE** . . . 600 lbs.
- EXT. ACTUATOR SPEED** . . . 1.0"/second
- CHARGE TIME** . . . Approx. 6 hours
- DIMENSIONS** . . . 60" H x 26" W x 36" D
- OPERATING DISTANCE** . . . 35 ft. wired; 300 ft. wireless<sup>‡</sup>

\*Number of operations is dependent on the nature of the operation

<sup>†</sup>May be custom ordered to match different local power standards

<sup>‡</sup>Standard configuration, contact CBS ArcSafe® for other options

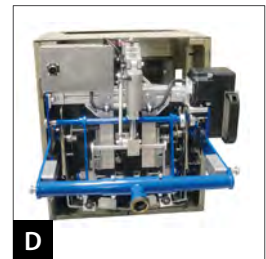

A) Allis-Chalmers, Siemens Allis, Siemens: MA-150, 250, 350B

B) Allis-Chalmers, Siemens Allis, Siemens: MA-150, 250, 350C

C) FPE: DST-II

D) GE: AK-1-25

# RRS-2 Guide to the RRS-2 Universal Extractor Remote Racking System

- 1 Slide Rail
- 2 Height Adjustment Lever
- 3 Wired Pendant Coil Cord
- 4 Wired Pendant Station
- 5 AC Power Input Receptacle
- 6 Storage Bag
- 7 Current Control Module (CCM)
- 8 PD Alert (Partial Discharge Sensor)
- 9 Control Cabinet
- 10 Power Supply
- 11 Steel Frame
- 12 Junction Box
- 13 Main Actuator
- 14 Tooling Attach Point
- 15 Cabinet Attachment Spreader Bar
- 16 Telescope Tube
- 17 Main Disconnect
- 18 Front Wheels
- 19 Rear Wheels





# RRS-2 BE Remote Racking System



The RRS-2 BE is designed specifically for motor control center (MCC) bucket removal applications where users normally would be required to perform the install or remove operation manually, exposing them to the potential hazards and lethal consequences of an arc flash. Designed to be extremely versatile, the RRS-2 BE is suited for use in all environments, from grueling applications in a power-generation facility to clean rooms at a high-tech manufacturing plant.

## BENEFITS

Setup and operation of the RRS-2 BE are very similar to that of the standard RRS-2, allowing users familiar with the RRS-2 to easily transition between the two devices with no additional training required. RRS-2 BE benefits include:

- Control cabinet housing all of the electronics vital for operation has been integrated into a separate rugged case for simple transportation and storage.
- Large linear actuator has been replaced with a compact, adjustable travel linear actuator more suited to the forces required for MMC buckets instead of large breakers.
- Steel frame of the RRS-2 has been modified to accept the specialized tooling required for MCC bucket install and to remove applications.
- Modular construction reduces weight compared to RRS-2 model.
- Dual-channel-enabled operation allows users to carefully control the MCC bucket install and remove operations.
- Intelligent AC/DC power system allows the unit to run on battery or AC power.
- Two-station high-reach vertical adjustment is capable of reaching MCC buckets up to 80 inches high. Also included is a wireless remote control, allowing users to operate the unit from up to 300 ft. away.

## SPECIFICATIONS

**WEIGHT** . . . 105 lbs.

**BATTERY LIFE** . . . >50 operations\*

**SYSTEM VOLTAGE** . . . 24 V DC

**INPUT VOLTAGE** . . . 120 ±10% V AC, 47-63 Hz<sup>†</sup>

**CHARGE TIME** . . . Approx. 4 hours

**DIMENSIONS** . . . 74" H x 25" W x 32" D

**OPERATING DISTANCE** . . . 300 ft.<sup>‡</sup>

\*Number of operations is dependent on the nature of the operation

<sup>†</sup>May be custom ordered to match different local power standards

<sup>‡</sup>Radio remote control standard on RRS-2 BE

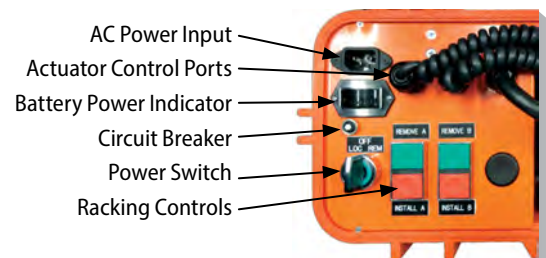

## RSO-IIBE FOR THE RRS-2 BE

The RSO-IIBE functions as the user interface for the RRS-2 BE MCC bucket racking system. The RSO-IIBE is housed in a rugged, portable case and uses many of the same components and controls as the control cabinet found on the RRS-2. The RSO-IIBE is designed to work specifically with the specialized tooling required for use with the RRS-2 BE and MCC buckets. The RSO-IIBE features an intelligent AC/DC power system that uses a power supply mounted to the RRS-2 BE frame to charge the internal batteries or run the unit off of AC power.

RSO-II: US PATENT NO. 8,161,631B1

- 1 Steel Frame
- 2 Radio Remote Control
- 3 Main Disconnect
- 4 Local Control
- 5 RSO-IIBE Controller
- 6 AC/DC Power Supply
- 7 Floor Locks
- 8 Height Adjustment Rail
- 9 Application-Specific Tooling
- 10 Extraction Actuator
- 11 Magnet Bar
- 12 Height-Adjustment Mount
- 13 Front Wheels
- 14 Rear Wheels



# RRS-2 Available Options

Some options not available for use with RRS-2 BE. Contact CBS ArcSafe for details.

## CCM Radio Remote

The CCM radio remote option allows users to operate the RRS and monitor the racking status wirelessly from up to 300 ft. away. Ideal for users with extended distance requirements or those who wish to monitor the status of the racking operation remotely.



## Wireless/Wired Video System

The wireless/wired video system allows users to monitor the remote racking operation from up to 300 ft. away using an RRS-mounted camera and stand-alone monitor. Ideal for users who will be visually separated from the RRS during the remote operation.

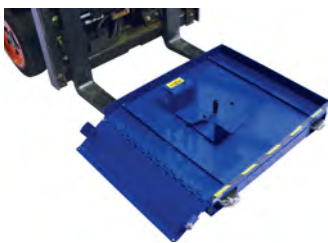

## Transport Skid

The transport skid features a built-in ramp for loading and unloading integrated spring-loaded latches to secure the ramp when not in use. Ideal for transporting equipment to remote or difficult-to-access locations.



## LED Light

The LED light accessory adds a forward-facing, high-intensity light source with pan-and-tilt capability to the front of the RRS. Ideal for setting up the RRS or installing RRS tooling in low-light environments.

## Water-Resistant Cover

It is recommended that the RRS be stored in a dry, temperature-controlled environment. Because this is not always possible, CBS ArcSafe offers a water-resistant cover that protects the RRS from contact with small amounts of liquid.



## Pneumatic Tires

The air-filled pneumatic tires provide a cushioning effect and reduce wear on the RRS unit during transport. Ideal for customer applications where transportation or use on uneven, rocky, or gravel surfaces is likely to occur.

# RRS-2

## Available Options

Some options not available for use with RRS-2 BE. Contact CBS ArcSafe for details.

### Wired Pendant Extensions

The wired pendant extension(s) allows users to operate the RRS from extended distances while remaining tethered to the unit. Ideal for use in facilities with extended distance requirements that also restrict radio-controlled device transmission.



### Stair Climber Rails

The stair climber rails provide a low-friction surface for use when transporting the RRS up and down stairs and provide a level of protection to the control cabinet during everyday use. Ideal for applications requiring transportation up or down stairways.



### PD Alert

**Partial Discharge: The First Line of Defense**

#### PD Alert Sensor

PD Alert provides an additional layer of safety for technicians tasked with racking or removing circuit breakers and motor control centers. In the event of a breakdown in line-to-line or line-to-ground insulation, the programmable PD Alert radio frequency (RF) noncontact sensor issues a visual strobe alarm or digital alarm via email or SMS text message. Compatible with RRS-1, RRS-1 LT, RRS-4, and RRS-2 only; also works as stand-alone sensor.



### High Lift

The high-lift option is required to remotely rack any equipment with a racking mechanism more than 66 inches off the ground. Ideal for users who wish to rack breakers with extremely high racking mechanisms that would otherwise cause issues during manual operation.



### Front Casters

The front casters allow for maximum mobility even in the tightest spaces, simplifying installation and setup in these locations. Ideal for tight or constrained areas where users may otherwise have difficulty maneuvering the RRS.

# RRS<sup>®</sup>-3 Apparatus-Specific Portable Remote Racking Systems



**CBS ArcSafe** apparatus-specific remote racking systems (RRS-3s) are designed to remotely rack a single style of circuit breaker utilizing a portable, stand-alone device. The RRS-3 units are most commonly assisted by strong magnets, eliminating the need to modify switchgear. This allows operators to easily move the RRS-3 from one breaker to another.

The RRS-3 system is an inexpensive apparatus-specific remote racking system that allows the operator to install and remove a breaker with a hand-control unit while standing up to 75 ft. away. Each **CBS ArcSafe** RRS-3 is custom built to your electrical equipment so that it can safely operate your switchgear.

**RRS-3 MBII**



**RRS-3 VCPR**



**RRS-3-AKD-10(S)**

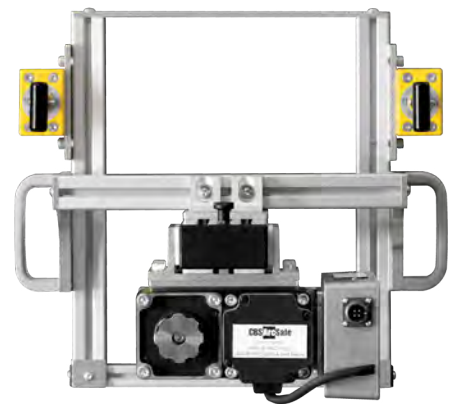

Compatible with all switchgear manufacturers, including:

- |                         |                                   |                           |                             |
|-------------------------|-----------------------------------|---------------------------|-----------------------------|
| ■ <b>ABB</b>            | ■ <b>Controlled Power</b>         | ■ <b>General Electric</b> | ■ <b>Reyrolle</b>           |
| ■ <b>AEG</b>            | ■ <b>Cutler-Hammer</b>            | ■ <b>Hyundai</b>          | ■ <b>Schneider Electric</b> |
| ■ <b>Allis-Chalmers</b> | ■ <b>Eaton</b>                    | ■ <b>ITE</b>              | ■ <b>Siemens</b>            |
| ■ <b>Alstom</b>         | ■ <b>Federal Pacific Electric</b> | ■ <b>McGraw-Edison</b>    | ■ <b>Siemens-Allis</b>      |
| ■ <b>Areva</b>          | ■ <b>Federal Pioneer</b>          | ■ <b>Merlin Gerin</b>     | ■ <b>Square D</b>           |
| ■ <b>Asea</b>           | ■ <b>Fuji</b>                     | ■ <b>Mitsubishi</b>       | ■ <b>Toshiba</b>            |
| ■ <b>BBC</b>            | ■ <b>GEC</b>                      | ■ <b>Powell</b>           | ■ <b>Westinghouse</b>       |

NOTE: All manufacturers' names, trademarks, and part numbers are used for reference purposes only. CBS ArcSafe, Inc., is not an authorized distributor or representative of manufacturers shown. Designated trademarks, brand names, and brands appearing herein are the property of their respective owners.



# Apparatus-Specific Portable Remote Racking System

## BENEFITS

- Lightweight, portable construction
- Mechanical and electrical safety protection
- Mechanical clutch over-racking protection
- Adjustable to fit unique equipment configurations
- Fast and easy to set up
- Reduced need for a full-body arc-flash suit
- Adds safety and helps comply with NFPA 70E
- No modifications required

## OPTIONAL FEATURES

- 25-foot pendant extensions
- 24 V DC LED light
- Wireless video camera system with LCD monitor
- Rugged protective case assembly

## RSO-IV-M18 for the RRS-3

**Most RRS-3s require the RSO-IV-M18 to operate.\***

The RSO-IV-M18 is a rechargeable 24 V DC power supply that, when used in conjunction with an appropriate RRS-3, will remotely perform any racking operation that would normally require local operation by trained personnel. Tasks the RSO and RRS-3 can perform include, but are not limited to, the following:

1. Installing and removing any switchgear utilizing a rotary racking mechanism
2. Installing and removing any switchgear utilizing a nonrotary racking mechanism
3. Engaging or disengaging mechanical or electrical interlocks, such as circuit breaker interlock foot pedals or buttons

**WEIGHT** . . . . 15 lbs.

**DIMENSIONS** . . . . 13.4" H x 16.7" W x 6.8" D

**BATTERY TYPE** . . . . 18 V Milwaukee M18 Lithium Ion

**BATTERY LIFE** . . . . 5.0 amp-hours

**OUTPUT VOLTAGE** . . . . 24 V DC

**ENCLOSURE RATING** . . . . Dust-proof (IP6X)

**ENCLOSURE MATERIAL** . . . . NK-7 high impact polypropylene

\*Some applications with interlocks will require various settings to be selected on the standard RSO-IV-M18 operator console.



## SPECIFICATIONS

### Radio Remote Pendant Station

**MAX. OPER. DISTANCE** . . . . 300 ft. (line of sight)

**FREQUENCY** . . . . ISM 2.4 GHz

**INTERFERENCE IMMUNITY** . . . . Direct sequence spread spectrum (DSSS) technology

**ENCRYPTION** . . . . 128/256 bit AES

**OPERATING TEMP.** . . . . -40°F to 185°F

**TRANSMITTER POWER** . . . . 2 AA Batteries

**INDICATORS** . . . . Power/Paired = Red

**TRANSMITTER WEIGHT** . . . . 7.2 oz.

**TRANSMITTER SIZE** . . . . 5.37" H x 2.68" W x 0.92" D

**TRANSMIT BUTTON LIFE** . . . . 5 million operations

NOTE: All manufacturers' names, trademarks, and part numbers are used for reference purposes only. CBS ArcSafe, Inc., is not an authorized distributor or representative of manufacturers shown. Designated trademarks, brand names, and brands appearing herein are the property of their respective owners.

**Current Control Module** CCMs ship with most RRS units and provide directional, timing, and current control in addition to other helpful features. For more information, see page 20.



Legacy CCM on RSO/RRS



Current CCM on RSO-IV-M18

# Manufacturer Index

<b>MANUFACTURER/EQUIPMENT TYPE</b>	<b>RRS-3 UNIT</b>	<b>PAGE</b>
ABB Type ADVAC with Closed-Door Lever Interlock	RRS-3 ADVAC (CDL)	37
ABB Type ADVAC with Closed-Door Push-Button Interlock	RRS-3 ADVAC (CDP)	37
ABB Type Vmax, 600-2000 A	RRS-3 Vmax	60
ABB/BBC/ITE Type HK	RRS-3 HK (Trolley Style)	46
ABB/BBC/ITE Type K-Line, 225-2000 A	RRS-3 KL(S)	48
ABB/BBC/ITE Type K-Line, 3000-4000 A	RRS-3 KL(L)	48
ABB/BBC/ITE Type LK	RRS-3 LK	49
ABB/BBC/ITE Type MB/MBE	RRS-3 ABB-MB	37
ABB/SACE Type Emax 2 sizes E2.2, E4.2, and E6.2	RRS-3 Emax2(L)	45
ABB/SACE Type Emax E1-E6, 800-5000 A	RRS-3 Emax	44
Allen-Bradley CENTERLINE 2100 MCCs	RRS-3 SecureConnect	56
Allis-Chalmers/Siemens-Allis Type LA, LAF (all sizes)	RRS-3 LAR1	49
Allis-Chalmers/Siemens-Allis Type LA/LAF, 3000-4000 A	RRS-3 LA(LE)	48
Controlled Power/Hitachi Type HVF	RRS-3 HVF	47
Cutler-Hammer/Eaton/Westinghouse Type 380VCP-W40 Large Breaker (Door Open Racking)	RRS-3 VCP-W(L)	59
Cutler-Hammer/Eaton/Westinghouse Type VCP-W	RRS-3 VCPR	59
Cutler-Hammer/Eaton/Westinghouse Type VCP-W, 1200-3000 A	RRS-3 VCP-W(S)	59
Cutler-Hammer/Square D/Westinghouse Type DS/DS II (all sizes)	RRS-3 DS	44
Cutler-Hammer/Square D/Westinghouse Type DS/DS II (all sizes)	RRS-3 DSR1	44
Eaton/Cutler-Hammer NRX NF-Frame	RRS-3 NRX(S)	52
Eaton/Cutler-Hammer NRX RF-Frame	RRS-3 NRX(L)	52
Eaton/Cutler-Hammer Type FlashGard	RRS-3 FlashGard	45
Eaton/Cutler-Hammer Type Magnum DS, SB, MW (MW1 and MWN), 800-5000 A	RRS-3 MDS	51
Eaton/Cutler-Hammer Type Magnum DS, Magnum SB, 800-4000 A, Magnum MW	RRS-3 MDSR1	51
FPE Type H-2/HL-2, 600-6000 & Type H-3/HL-3, 600-4000 A	RRS-3 H-2/H-3	46
FPE Type H/H-1, 600-6000 A (Includes 25, 50, 75, 100 H/H-1/HF/HF-1)	RRS-3 100H1	36
GE Type AK-1-25 ACB	RRS-3 AKD-5(SE1)	39
GE Type AK, 1600-3200 A	RRS-3 AKD (ME)	38
GE Type AK, 1600-4000 A	RRS-3 AKD-5	38
GE Type AK, 225-600 A	RRS-3 AKD-5(S)	38
GE Type AKR, 3200-4000 A	RRS-3 AKD-8(L)	40
GE Type AKR, 800-2000 A	RRS-3 AKD-6	39
GE Type AKR, 800-2000 A	RRS-3 AKD-8	39
GE Type AKR, 800-2000 A	RRS-3 AKD-8(S)	40
GE Type AM	RRS-3 MB II	50
GE Type AMH, 1200-2000 A	RRS-3 AMH	41
GE Type ENTELLIGUARD G, 400-6000 A	RRS-3 EntelliGuard G	45
GE Type PowerBreak I, 3000 A and above; racking mechanism on left side	RRS-3 PBI(L)	53
GE Type PowerBreak II, 800-2500 A	RRS-3 PBII(S)	53

See product page for more specific breaker compatibility descriptions.

<b>MANUFACTURER/EQUIPMENT TYPE</b>	<b>RRS-3 UNIT</b>	<b>PAGE</b>
GE Type SecoVac VB2+, 1200-3000 A	RRS-3 SecoVac (IEEE)	56
GE Type VB, 1200-3000 A	RRS-3 VB	58
GE Type VH	RRS-3 VH	60
GE Type WavePro, 3200-5000 A , ENTELLIGUARD, 3200-5000 A	RRS-3 AKD-10(L)	40
GE Type WavePro, 800-2000 A	RRS-3 AKD-10(S)	41
ITE Type HV, 600-1200 A & 2000 A, 150-200 MVA	RRS-3 HV	47
ITE Type KB, 100-600 A & TYPE KC, 200-1600 A	RRS-3 KB/KC	47
LS Type D, E, and G	RRS-3 LS ACB	49
LS Type VCB VH	RRS-3 LS VCB VH	50
LS Type VCB VL	RRS-3 LS VCB VL	50
McGraw-Edison/North American Switchgear Type PSD	RRS-3 PSD	55
Merlin Gerin/Schneider Electric Type Compact NS	RRS-3 Compact NS	41
Merlin Gerin/Schneider Electric Type Masterpact MP/MC, 800-6000 A	RRS-3 MP/MC	51
Merlin Gerin/Schneider Electric Type Selpact	RRS-3 Selpact	57
Merlin Gerin/Schneider Electric/Square D Type Masterpact NT, 800-1600 A	RRS-3 NT	52
Merlin Gerin/Schneider Electric/Square D Type Masterpact NW, 800-6000 A	RRS-3 NW	53
Powell Type PV, 27-38 kV; Closed-Door Application	RRS-3 PowIVac (L)	54
Powell Type PV, 1200-3000 A; Closed-Door Application	RRS-3 PowIVac (CDR)	54
Powell Type PV, 1200-3000 A; Open-Door Application	RRS-3 PowIVac (STD)	54
Schneider Electric/Square D Type Square D Model 6 MCC	RRS-3 SDR1	56
Schneider Electric/Square D Type VR, 1200-3000 A	RRS-3 VR	61
Siemens Type GMI, 1200-3000 A	RRS-3 GMI	46
Siemens Type WL, 800-6000 A	RRS-3 WL	61
Siemens/Siemens-Allis 8BK20 Series	RRS-3 8BK20	36
Siemens/Siemens-Allis Type 3AF, 1200-3000 A	RRS-3 3AF	36
Siemens/Siemens-Allis Type RL, RLE, RLF (all sizes)	RRS-3 RLR1	55
Square D Type VAD-3/VAD-4/VAD-5	RRS-3 VAD 3/4/5	58
Terasaki Type TemPower2	RRS-3 TemPower2(3)	57
Terasaki Type Tempro AT	RRS-3 Terasaki AT	57
Toshiba Type VK; Closed-Door Application	RRS-3 VK-VH1	60
Westinghouse Type DB-25	RRS-3 DB-25	42
Westinghouse Type DB-50, 240-600 A & Type DBL-50, 200-1600 A	RRS-3 DB-50	42
Westinghouse Type DB-75, 3000 A & Type DB-100, 4000 A	RRS-3 DB-75/100	42
Westinghouse Type DH (includes 50DH150, 2000 A; 50DH250, 2000 A; 50DH350, 1200-3000 A; 75DH150, 600-1200 A; 75DH250, 1200-2000 A; 75DH500, 1200-2000 A; 150DH150, 600-1200 A; 150DH250, 1200-2000 A; 150DH500, 1200-2000 A; 150DH750, 1200-2000 A; 150DH1000, 1200-3000 A)	RRS-3 DH(L)	43
Westinghouse Type DH (includes 50DH150, 600-1200 A; 50DH250, 600-1200 A)	RRS-3 DH(S)	43
Westinghouse Type DHP/DVP (includes 50DHP75, 1200 A; 50DHP250, 1200-2000 A; 50DHP350, 1200-2000 A; 50DHP350, 3000 A; 50DHP500, 1200-3000 A; 150DHP500, 1200-3000 A; 150DHP750, 1200-3000 A; 150DHP1000, 1200-3000 A)	RRS-3 DHP (Trolley Style)	43
Westinghouse Type SB, 400, 800, and 1200 A frame sizes	RRS-3 SB(1)	55
Westinghouse Type VCP, 1200-3000 A	RRS-3 VCP	58

See product page for more specific breaker compatibility descriptions.

# Product Index

<b>RRS-3 UNIT</b>	<b>MANUFACTURER/EQUIPMENT TYPE</b>	<b>PAGE</b>
RRS-3 100H1	FPE Type H/H-1, 600-6000 A (Includes 25, 50, 75, 100 H/H-1/HF/HF-1)	36
RRS-3 3AF	Siemens/Siemens-Allis Type 3AF, 1200-3000 A	36
RRS-3 8BK20	Siemens/Siemens-Allis 8BK20 Series	36
RRS-3 ABB-MB	ABB/BBC/ITE Type MB/MBE	37
RRS-3 ADVAC (CDL)	ABB Type ADVAC with Closed-Door Lever Interlock	37
RRS-3 ADVAC (CDP)	ABB Type ADVAC with Closed-Door Push-Button Interlock	37
RRS-3 AKD (ME)	GE Type AK, 1600-3200 A	38
RRS-3 AKD-5	GE Type AK, 1600-4000 A	38
RRS-3 AKD-5(S)	GE Type AK, 225-600 A	38
RRS-3 AKD-5(SE1)	GE Type AK-1-25 ACB	39
RRS-3 AKD-6	GE Type AKR, 800-2000 A	39
RRS-3 AKD-8	GE Type AKR, 800-2000 A	39
RRS-3 AKD-8(L)	GE Type AKR, 3200-4000 A	40
RRS-3 AKD-8(S)	GE Type AKR, 800-2000 A	40
RRS-3 AKD-10(L)	GE Type WavePro, 3200-5000 A , EntelliGuard, 3200-5000 A	40
RRS-3 AKD-10(S)	GE Type WavePro, 800-2000 A	41
RRS-3 AMH	GE Type AMH, 1200-2000 A	41
RRS-3 Compact NS	Merlin Gerin/Schneider Electric Type Compact NS	41
RRS-3 DB-25	Westinghouse Type DB-25	42
RRS-3 DB-50	Westinghouse Type DB-50, 240-600 A & Type DBL-50, 200-1600 A	42
RRS-3 DB-75/100	Westinghouse Type DB-75, 3000 A & Type DB-100, 4000 A	42
RRS-3 DH(L)	Westinghouse Type DH (includes 50DH150, 2000 A; 50DH250, 2000 A; 50DH350, 1200-3000 A; 75DH150, 600-1200 A; 75DH250, 1200-2000 A; 75DH500, 1200-2000 A; 150DH150, 600-1200 A; 150DH250, 1200-2000 A; 150DH500, 1200-2000 A; 150DH750, 1200-2000 A; 150DH1000, 1200-3000 A)	43
RRS-3 DH(S)	Westinghouse Type DH (includes 50DH150, 600-1200 A; 50DH250, 600-1200 A)	43
RRS-3 DHP (Trolley Style)	Westinghouse Type DHP/DVP (includes 50DHP75, 1200 A; 50DHP250, 1200-2000 A; 50DHP350, 1200-2000 A; 50DHP350, 3000 A; 50DHP500, 1200-3000 A; 150DHP500, 1200-3000 A; 150DHP750, 1200-3000 A; 150DHP1000, 1200-3000 A)	43
RRS-3 DS	Cutler-Hammer/Square D/Westinghouse Type DS/DS II (all sizes)	44
RRS-3 DSR1	Cutler-Hammer/Square D/Westinghouse Type DS/DS II (all sizes)	44
RRS-3 Emax	ABB/SACE Type Emax E1-E6, 800-5000 A	44
RRS-3 Emax2(L)	ABB/SACE Type Emax 2 sizes E2.2, E4.2, and E6.2	45
RRS-3 EntelliGuard G	GE Type EntelliGuard G, 400-6000 A	45
RRS-3 FlashGard	Eaton/Cutler-Hammer Type FlashGard	45
RRS-3 GMI	Siemens Type GMI, 1200-3000 A	46
RRS-3 H-2/H-3	FPE Type H-2/HL-2, 600-6000 & Type H-3/HL-3, 600-4000 A	46
RRS-3 HK (Trolley Style)	ABB/BBC/ITE Type HK	46
RRS-3 HV	ITE Type HV, 600-1200 A & 2000 A, 150-200 MVA	47
RRS-3 HVF	Controlled Power/Hitachi Type HVF	47
RRS-3 KB/KC	ITE Type KB, 100-600 A & Type KC, 200-1600 A	47
RRS-3 KL(L)	ABB/BBC/ITE Type K-Line, 3000-4000 A	48

See product page for more specific breaker compatibility descriptions.

<b>RRS-3 UNIT</b>	<b>MANUFACTURER/EQUIPMENT TYPE</b>	<b>PAGE</b>
RRS-3 KL(S)	ABB/BBC/ITE Type K-Line, 225-2000 A	48
RRS-3 LA(LE)	Allis-Chalmers/Siemens-Allis Type LA/LAF, 3000-4000 A	48
RRS-3 LAR1	Allis-Chalmers/Siemens-Allis Type LA, LAF (all sizes)	49
RRS-3 LK	ABB/BBC/ITE Type LK	49
RRS-3 LS ACB	LS Type D, E, and G	49
RRS-3 LS VCB VH	LS Type VCB VH	50
RRS-3 LS VCB VL	LS Type VCB VL	50
RRS-3 MB II	GE Type AM	50
RRS-3 MDS	Eaton/Cutler-Hammer Type Magnum DS, SB, MW (MW1 and MWN), 800-5000 A	51
RRS-3 MDSR1	Eaton/Cutler-Hammer Type Magnum DS, Magnum SB, 800-4000 A, Magnum MW	51
RRS-3 MP/MC	Merlin Gerin/Schneider Electric Type Masterpact MP/MC, 800-6000 A	51
RRS-3 NRX(L)	Eaton/Cutler-Hammer NRX RF-Frame	52
RRS-3 NRX(S)	Eaton/Cutler-Hammer NRX NF-Frame	52
RRS-3 NT	Merlin Gerin/Schneider Electric/Square D Type Masterpact NT, 800-1600 A	52
RRS-3 NW	Merlin Gerin/Schneider Electric/Square D Type Masterpact NW, 800-6000 A	53
RRS-3 PBI(L)	GE Type PowerBreak I, 3000 A and above; racking mechanism on left side	53
RRS-3 PBII(S)	GE Type PowerBreak II, 2500 A and below	53
RRS-3 PowlVac (CDR)	Powell Type PV, 1200-3000 A; Closed-Door Application	54
RRS-3 PowlVac (L)	Powell Type PV, 27-38 kV; Closed-Door Application	54
RRS-3 PowlVac (STD)	Powell Type PV, 1200-3000 A; Open-Door Application	54
RRS-3 PSD	McGraw-Edison/North American Switchgear Type PSD	55
RRS-3 RLR1	Siemens/Siemens-Allis Type RL, RLE, RLF (all sizes)	55
RRS-3 SB(1)	Westinghouse Type SB, 400, 800, and 1200 A frame sizes	55
RRS-3 SDR1	Schneider Electric/Square D Type Square D Model 6 MCC	56
RRS-3 SecoVac (IEEE)	GE Type SecoVac VB2+, 1200-3000 A	56
RRS-3 SecureConnect	Allen-Bradley CENTERLINE 2100 MCCs	56
RRS-3 Selpact	Merlin Gerin/Schneider Electric Type Selpact	57
RRS-3 TemPower2(3)	Terasaki Type TemPower2	57
RRS-3 Terasaki AT	Terasaki Type Tempro AT	57
RRS-3 VAD 3/4/5	Square D Type VAD-3/VAD-4/VAD-5	58
RRS-3 VB	GE Type VB, 1200-3000 A	58
RRS-3 VCP	Westinghouse Type VCP, 1200-3000 A	58
RRS-3 VCP-W(L)	Cutler-Hammer/Eaton/Westinghouse Type 380VCP-W40 Large Breaker (Door Open Racking)	59
RRS-3 VCP-W(S)	Cutler-Hammer/Eaton/Westinghouse Type VCP-W, 1200-3000 A	59
RRS-3 VCPR	Cutler-Hammer/Eaton/Westinghouse Type VCP-W	59
RRS-3 VH	GE Type VH	60
RRS-3 VK-VH1	Toshiba Type VK; Closed-Door Application	60
RRS-3 Vmax	ABB Type Vmax, 600-2000 A	60
RRS-3 VR	Schneider Electric/Square D Type VR, 1200-3000 A	61
RRS-3 WL	Siemens Type WL, 800-6000 A	61

\*All unit measurements are L x W x H

# RRS-3 100H1

FOR USE WITH:  
**Federal Pacific Electric  
Air Circuit Breaker**



## SPECIFICATIONS

**WEIGHT:** 30.0 lbs.

**DIMENSIONS:**\* 18.0" x 15.0" x 17.7"

**COMPATIBLE WITH:** Type H/H-1,  
600-6000 A (includes 25, 50, 75, 100  
H/H-1/HF/HF-1)

**CONTROL/POWER SOURCE:**  
RSO-IV-M18



# RRS-3 3AF

FOR USE WITH:  
**Siemens/Siemens-Allis  
Vacuum Circuit Breaker**

## SPECIFICATIONS

**WEIGHT:** 21.1 lbs.

**DIMENSIONS:**\* 15.1" x 6.3" x 14.4"

**COMPATIBLE WITH:** Type 3AF,  
1200-3000 A (includes 5, 7,  
15-3AF-250, 350, 500, 750, 1000)

**CONTROL/POWER SOURCE:**  
RSO-IV-M18



# RRS-3 8BK20

FOR USE WITH:  
**Siemens/Siemens-Allis  
Air Circuit Breaker**



## SPECIFICATIONS

**WEIGHT:** 19.9 lbs.

**DIMENSIONS:**\* 14.1" x 6.3" x 14.4"

**COMPATIBLE WITH:** 8BK20 Series  
Switchgear Utilizing a 12 mm Socket  
for the Racking Mechanism

**CONTROL/POWER SOURCE:**  
RSO-IV-M18



\*All unit measurements are L x W x H

# RRS-3

## ABB-MB

FOR USE WITH:  
**ABB/BBC/ITE Air Circuit Breaker**

### SPECIFICATIONS

WEIGHT: 18.0 lbs.

DIMENSIONS:\* 8.5" x 13.8" x 6.5"

COMPATIBLE WITH: Type MB, MBE (includes MB, MBE-8, 16, 20, 25, 32, 42)

CONTROL/POWER SOURCE:  
RSO-IV-M18



# RRS-3

## ADVAC (CDL)

FOR USE WITH:  
**ABB ADVAC Vacuum Circuit Breaker**

### SPECIFICATIONS

WEIGHT: 25.0 lbs.

DIMENSIONS:\* 10.5" x 19.0" x 10.0"

COMPATIBLE WITH: Type ADVAC (includes 5-15 kV, 1200-3000 A, Closed Door with Lever Interlock)

CONTROL/POWER SOURCE:  
RSO-IV-M18



# RRS-3

## ADVAC (CDP)

FOR USE WITH:  
**ABB ADVAC Vacuum Circuit Breaker**

### SPECIFICATIONS

WEIGHT: 25.0 lbs.

DIMENSIONS:\* 6.8" x 18.0" x 6.2"

COMPATIBLE WITH: Type ADVAC (includes 5-15 kV, 1200-3000 A, Closed Door with Push-Button Interlock)

CONTROL/POWER SOURCE:  
RSO-IV-M18



\*All unit measurements are L x W x H

# RRS-3

## AKD (ME)

FOR USE WITH:

**General Electric  
Air Circuit Breaker**

### SPECIFICATIONS

**WEIGHT:** 31.8 lbs.

**DIMENSIONS:\*** 19.8" x 23.2" x 20.7"

**COMPATIBLE WITH:** Type AK,  
1600-3200 A (includes AK, AKU - 1,  
2, 3 - 50, 50S, 75, 75S)

**CONTROL/POWER SOURCE:**  
RSO-IV-M18



# RRS-3

## AKD-5

FOR USE WITH:

**General Electric  
Air Circuit Breaker**

### SPECIFICATIONS

**WEIGHT:** 19.6 lbs.

**DIMENSIONS:\*** 18.7" x 6.5" x 8.4"

**COMPATIBLE WITH:** Type AK,  
1600-4000 A (includes AK, AKU - 2A,  
3A, 4A, 5A - 50, 50S, 75, 75S,  
100, 100S)

**CONTROL/POWER SOURCE:**  
RSO-IV-M18

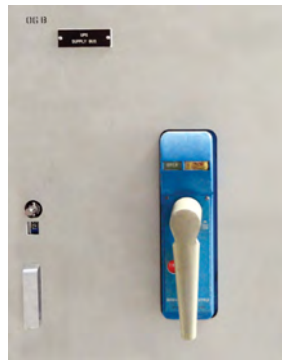

# RRS-3

## AKD-5(S)

FOR USE WITH:

**General Electric  
Air Circuit Breaker**

### SPECIFICATIONS

**WEIGHT:** 16.7 lbs.

**DIMENSIONS:\*** 10.2" x 9.0" x 9.1"

**COMPATIBLE WITH:** Type AK,  
225-600 A (includes AK, AKF,  
AKU - 2A, 3A - 15, 25)

**CONTROL/POWER SOURCE:**  
RSO-IV-M18



\*All unit measurements are L x W x H

# RRS-3

## AKD-5(SE1)

FOR USE WITH:

**General Electric  
Air Circuit Breaker**

### SPECIFICATIONS

WEIGHT: 27.9 lbs.

DIMENSIONS:\* 20.3" x 21.5" x 11.9"

COMPATIBLE WITH: Type AK-1-25 ACB

CONTROL/POWER SOURCE: RSO-IV-M18

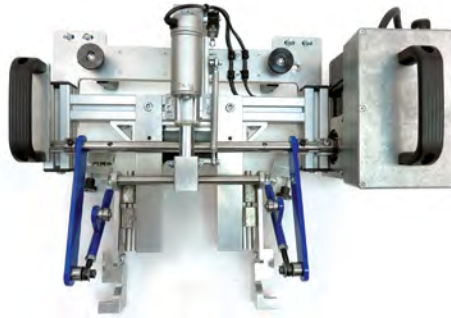

# RRS-3

## AKD-6

FOR USE WITH:

**General Electric  
Air Circuit Breaker**

### SPECIFICATIONS

WEIGHT: 25.0 lbs.

DIMENSIONS:\* 12.0" x 14.0" x 15.5"

COMPATIBLE WITH: Type AKR, 800-2000 A (includes AKR, AKRT, AKRU - 4A, 4B, 5A, 5B - 30, 30H, 50, 50H)

CONTROL/POWER SOURCE: RSO-IV-M18



# RRS-3

## AKD-8

FOR USE WITH:

**General Electric  
Air Circuit Breaker**

### SPECIFICATIONS

WEIGHT: 13.6 lbs.

DIMENSIONS:\* 7.4" x 7.3" x 12.3"

COMPATIBLE WITH: Type AKR, 800-2000 A (includes AKR, AKRT, AKRU - 6D, 7D, 8D, 9D, 10D - 30, 30H, 50, 50H)

CONTROL/POWER SOURCE: RSO-IV-M18



\*All unit measurements are L x W x H

# RRS-3

## AKD-8(L)

FOR USE WITH:

**General Electric  
Air Circuit Breaker**

### SPECIFICATIONS

**WEIGHT:** 25.0 lbs.

**DIMENSIONS:**\* 14.1" x 10.3" x 16.7"

**COMPATIBLE WITH:** Type AKR, 3200-4000 A (includes AKR, AKRT, AKRU - 6D, 7D, 8D, 9D, 10D - 75, 75H, 100, 100H)

**CONTROL/POWER SOURCE:** RSO-IV-M18



# RRS-3

## AKD-8(S)

FOR USE WITH:

**General Electric  
Air Circuit Breaker**

### SPECIFICATIONS

**WEIGHT:** 25.0 lbs.

**DIMENSIONS:**\* 14.1" x 10.3" x 16.7"

**COMPATIBLE WITH:** Type AKR, 800-2000 A (includes AKR, AKRU - 6D, 7D, 8D, 9D, 10D - 30S)

**CONTROL/POWER SOURCE:** RSO-IV-M18

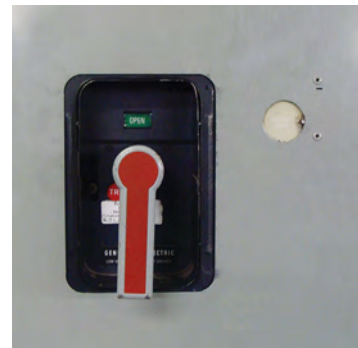

# RRS-3

## AKD-10(L)

FOR USE WITH:

**General Electric  
Air Circuit Breaker**

### SPECIFICATIONS

**WEIGHT:** 30.4 lbs.

**DIMENSIONS:**\* 16.6" x 19.0" x 17.0"

**COMPATIBLE WITH:** Type WavePro, 3200-5000 A (includes WPS, WPH, WPX - 32, 40, 50) & Type EntelliGuard, 3200-5000 A (includes EGS, EGH, EGX - 32, 40, 50)

**CONTROL/POWER SOURCE:** RSO-IV-M18



\*All unit measurements are L x W x H

# RRS-3

## AKD-10(S)

FOR USE WITH:

**General Electric  
Air Circuit Breaker**

### SPECIFICATIONS

**WEIGHT:** 30.4 lbs.

**DIMENSIONS:**\* 16.6" x 19.0" x 17.0"

**COMPATIBLE WITH:** Type WavePro, 800-2000 A (includes WPS, WPH, WPX - 08, 16, 20) & Type EntelliGuard, 800-2000 A (includes EGS, EGH, EGX - 08, 16, 20)

**CONTROL/POWER SOURCE:**  
RSO-IV-M18



# RRS-3

## AMH

FOR USE WITH:

**General Electric  
Air Circuit Breaker**

### SPECIFICATIONS

**WEIGHT:** 36.5 lbs.

**DIMENSIONS:**\* 13.5" x 21.0" x 15.0"

**COMPATIBLE WITH:** Type AMH, 1200-2000 A (includes AMH-4.76-100, 250, 350-0D, 1D)

**CONTROL/POWER SOURCE:**  
RSO-IV-M18



# RRS-3

## Compact NS

FOR USE WITH:

**Merlin Gerin/Schneider Electric  
Molded Case Circuit Breaker**

### SPECIFICATIONS

**WEIGHT:** 16.0 lbs.

**DIMENSIONS:**\* 17.7" x 10.9" x 19.8"

**COMPATIBLE WITH:** Type Compact NS (Electrically Operated, Housed within Withdrawable Circuit Breaker Chassis)

**CONTROL/POWER SOURCE:**  
RSO-IV-M18



\*All unit measurements are L x W x H

# RRS-3

## DB-25

FOR USE WITH:

**Westinghouse Air  
Circuit Breaker**



### SPECIFICATIONS

**WEIGHT:** 35.0 lbs.

**DIMENSIONS:\*** 19.3" x 18.0" x 10.0"

**COMPATIBLE WITH:** Type DB-25;  
Cubicle Width Must be Specified at  
Time of Order

**CONTROL/POWER SOURCE:**  
RSO-IV-M18

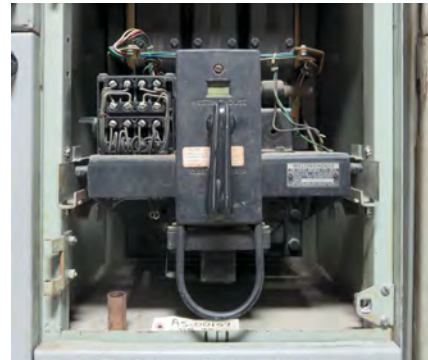

# RRS-3

## DB-50

FOR USE WITH:

**Westinghouse  
Air Circuit Breaker**



### SPECIFICATIONS

**WEIGHT:** 40.0 lbs.

**DIMENSIONS:\*** 30.2" x 25.1" x 10.0"

**COMPATIBLE WITH:** Type DB-50,  
240-600 A & DBL-50, 200-1600 A

**CONTROL/POWER SOURCE:**  
RSO-IV-M18



# RRS-3

## DB-75/100

FOR USE WITH:

**Westinghouse  
Air Circuit Breaker**

### SPECIFICATIONS

**WEIGHT:** 22.4 lbs.

**DIMENSIONS:\*** 21.3" x 7.3" x 13.2"

**COMPATIBLE WITH:** Type DB-75,  
3000 A & Type DB-100, 4000 A  
(includes DB-75/100)

**CONTROL/POWER SOURCE:**  
RSO-IV-M18

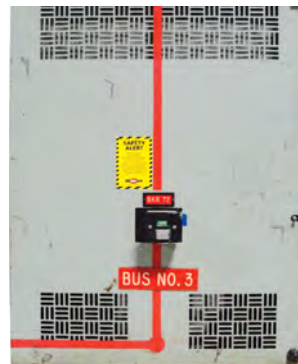

\*All unit measurements are L x W x H

# RRS-3

## DH(L)

FOR USE WITH:  
**Westinghouse  
Air Circuit Breaker**

### SPECIFICATIONS

WEIGHT: 38.4 lbs.

DIMENSIONS:\* 14.3" x 30.6" x 16.1"

COMPATIBLE WITH: Type DH (includes 50DH150, 2000 A; 50DH250, 2000 A; 50DH350, 1200-3000 A; 75DH150, 600-1200 A; 75DH250, 1200-2000 A; 75DH500, 1200-2000 A; 150DH150, 600-1200 A; 150DH250, 1200-2000 A; 150DH500, 1200-2000 A; 150DH750, 1200-2000 A; 150DH1000, 1200-3000 A)

CONTROL/POWER SOURCE: RSO-IV-M18

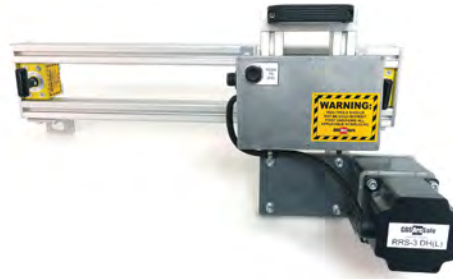

# RRS-3

## DH(S)

FOR USE WITH:  
**Westinghouse  
Air Circuit Breaker**

### SPECIFICATIONS

WEIGHT: 31.2 lbs.

DIMENSIONS:\* 14.3" x 20.5" x 15.5"

COMPATIBLE WITH: Type DH (includes 50DH150, 600-1200 A; 50DH250, 600-1200 A)

CONTROL/POWER SOURCE: RSO-IV-M18



# RRS-3

## DHP (Trolley Style)

FOR USE WITH:  
**Westinghouse Air  
Circuit Breaker**



### SPECIFICATIONS

WEIGHT: 60.0 lbs.

DIMENSIONS:\* 15.5" x 15.5" x 25.3"

COMPATIBLE WITH: Type DHP/DVP (includes 50DHP75, 1200 A; 50DHP250, 1200-2000 A; 50DHP350, 1200-2000 A; 50DHP350, 3000 A; 50DHP500, 1200-3000 A; 150DHP500, 1200-3000 A; 150DHP750, 1200-3000 A; 150DHP1000, 1200-3000 A)

CONTROL/POWER SOURCE: RSO-IV-M18



# RRS-3

## DS

FOR USE WITH:

**Cutler-Hammer/Eaton/Square D/Westinghouse  
Air Circuit Breaker**

### SPECIFICATIONS

**WEIGHT:** 17.5 lbs.

**DIMENSIONS:\*** 10.5" x 9.75" x 13.6"

**COMPATIBLE WITH:** Type DS/DS II (All Sizes)

**CONTROL/POWER SOURCE:**  
RSO-IV-M18



# RRS-3

## DSR1

FOR USE WITH:

**Cutler-Hammer/Eaton/Square D/Westinghouse  
Air Circuit Breaker**

### SPECIFICATIONS

**WEIGHT:** 6.2 lbs.

**DIMENSIONS:\*** 12.1" x 4.6" x 4.5"

**COMPATIBLE WITH:** Type DS/DS II (All Sizes)

**CONTROL/POWER SOURCE:**  
Milwaukee M18 RedLithium Ion



# RRS-3

## Emax

FOR USE WITH:

**ABB/SACE  
Air Circuit Breaker**

### SPECIFICATIONS

**WEIGHT:** 29.3 lbs.

**DIMENSIONS:\*** 20.8" x 16.8" x 12.1"

**COMPATIBLE WITH:** Type Emax,  
800-5000 A (includes E1, E2, E3,  
E4, E5, E6)

**CONTROL/POWER SOURCE:**  
RSO-IV-M18



\*All unit measurements are L x W x H

# RRS-3

## Emax2(L)

FOR USE WITH:  
**ABB/SACE Insulated  
Case Circuit Breaker**



### SPECIFICATIONS

WEIGHT: 32.0 lbs.

DIMENSIONS:\* 13.4" x 20.8" x 18.0"

COMPATIBLE WITH: Type Emax 2 sizes E2.2, E4.2, and E6.2; Not Compatible with Size 1.2

CONTROL/POWER SOURCE:  
RSO-IV-M18



# RRS-3

## EntelliGuard G

FOR USE WITH:  
**General Electric  
Air Circuit Breaker**

### SPECIFICATIONS

WEIGHT: 22.0 lbs.

DIMENSIONS:\* 12.0" x 17.8" x 18.5"

COMPATIBLE WITH: Type EntelliGuard G, 400-6000 A (includes GG, GJ, GH, GK-04, 07, 08, 10, 13, 16, 20, 25, 32, 40, 50, 64)

CONTROL/POWER SOURCE:  
RSO-IV-M18



# RRS-3

## FlashGard

FOR USE WITH:  
**Eaton/Cutler-Hammer  
Motor Control Center**



### SPECIFICATIONS

WEIGHT: 14.0 lbs.

DIMENSIONS:\* 6.8" x 8.9" x 9.5"

COMPATIBLE WITH: FlashGard MCC Isolator Rotary Mechanism Operator

CONTROL/POWER SOURCE:  
RSO-IV-M18



\*All unit measurements are L x W x H

# RRS-3

## GMI

FOR USE WITH:

**Siemens  
Vacuum Circuit Breaker**

### SPECIFICATIONS

**WEIGHT:** 21.0 lbs.

**DIMENSIONS:**\* 11.0" x 8.5" x 26.5"

**COMPATIBLE WITH:** Type GMI, 1200-3000 A (includes 5-GMI, 7-GMI, 15-GMI) & Type 3AF, 1200-3000 A (includes 5-3AF, 7-3AF, 15-3AF)

**CONTROL/POWER SOURCE:**  
RSO-IV-M18

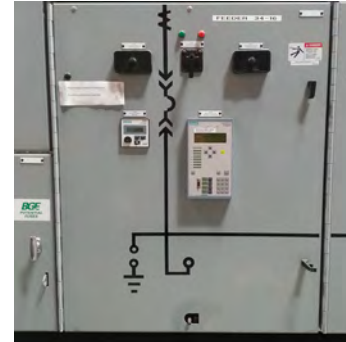

# RRS-3

## H-2/H-3

FOR USE WITH:

**Federal Pacific Electric  
Air Circuit Breaker**

### SPECIFICATIONS

**WEIGHT:** 27.9 lbs.

**DIMENSIONS:**\* 14.0" x 14.8" x 13.1"

**COMPATIBLE WITH:** Type H-2, HL-2, 600-6000 A (includes 25, 35, 50, 65, 75, 100 H, HL-2) & Type H-3, HL-3, 600-4000 A (includes 30, 42, 50, 65, 75, 100 H, HL-3)

**CONTROL/POWER SOURCE:**  
RSO-IV-M18

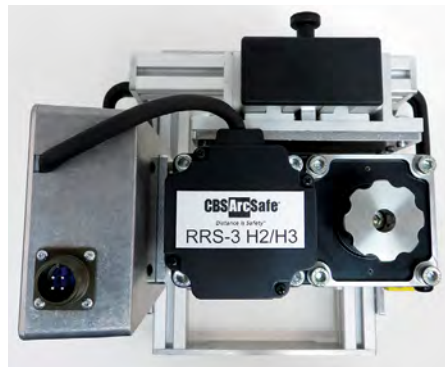

# RRS-3

## HK (Trolley Style)

FOR USE WITH:

**ABB/BBC/ITE Air  
Circuit Breaker**



### SPECIFICATIONS

**WEIGHT:** 67.0 lbs.

**DIMENSIONS:**\* 14.5" x 15.5" x 26.0"

**COMPATIBLE WITH:** Type HK (includes 5HK, 7.5HK, 15HK; 1200-3000 A; 75-750 MVA); Not Compatible with HK 1000; Not Compatible with Two-High Stacked Variant

**CONTROL/POWER SOURCE:**  
RSO-IV-M18



\*All unit measurements are L x W x H

# RRS-3

## HV

FOR USE WITH:

**ITE**  
**Air Circuit Breaker**

### SPECIFICATIONS

WEIGHT: 28.3 lbs.

DIMENSIONS:\* 12.5" x 10.5" x 17.8"

COMPATIBLE WITH: Type HV 5 kV, 600-1200 A & 2000 A, 150-250 MVA

CONTROL/POWER SOURCE:  
RSO-IV-M18

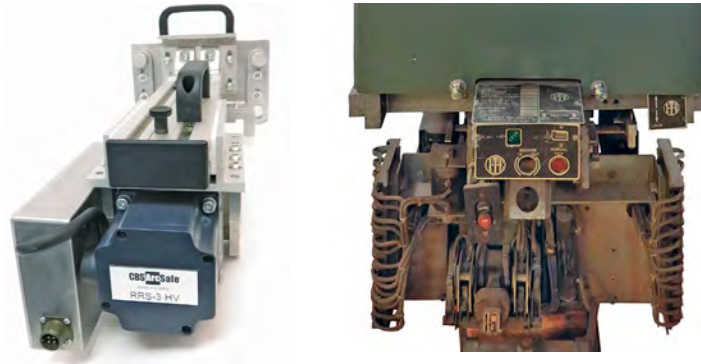

# RRS-3

## HVF

FOR USE WITH:

**Controlled Power/**  
**Hitachi Vacuum Circuit Breaker**

### SPECIFICATIONS

WEIGHT: 18.5 lbs.

DIMENSIONS:\* 13.3" x 9.5" x 9.9"

COMPATIBLE WITH: Type HVF for Open-Door Racking with Interlock Release Lever on the Left Side

CONTROL/POWER SOURCE:  
RSO-IV-M18



# RRS-3

## KB/KC

FOR USE WITH:

**ITE**  
**Air Circuit Breaker**

### SPECIFICATIONS

WEIGHT: 13.0 lbs.

DIMENSIONS:\* 11.2" x 17.9" x 15.6"

COMPATIBLE WITH: Type KB, 100-600 A & Type KC, 200-1600 A (includes KB, KB-E, KB-G, KC, KC-E, KC-G)

CONTROL/POWER SOURCE:  
RSO-IV-M18



\*All unit measurements are L x W x H

# RRS-3 KL(L)

FOR USE WITH:  
**ABB/BBC/ITE**  
**Air Circuit Breaker**

## SPECIFICATIONS

**WEIGHT:** 20.2 lbs.

**DIMENSIONS:**\* 15.5" x 9.0" x 10.4"

**COMPATIBLE WITH:** Type K-Line, 3000-4000 A (includes K-3000(S), 4000(S))

**CONTROL/POWER SOURCE:**  
RSO-IV-M18



# RRS-3 KL(S)

FOR USE WITH:  
**ABB/BBC/ITE**  
**Air Circuit Breaker**

## SPECIFICATIONS

**WEIGHT:** 17.6 lbs.

**DIMENSIONS:**\* 10.1" x 8.2" x 9.7"

**COMPATIBLE WITH:** Type K-Line, 225-2000 A (includes K-225(S), 600(S), 800(S), 1200(S), 1600(S), 2000(S))

**CONTROL/POWER SOURCE:**  
RSO-IV-M18



# RRS-3 LA(LE)

FOR USE WITH:  
**Allis-Chalmers/Siemens-Allis**  
**Air Circuit Breaker**



## SPECIFICATIONS

**WEIGHT:** 33.0 lbs.

**DIMENSIONS:**\* 14.8" x 17.9" x 22.8"

**COMPATIBLE WITH:** Type LA/LAF 3000-4000 A; (Silver Metal Face, Electrically-Operated, includes LA/LAF-3000, 3200, 4000 A); Racking Mechanism in Top Center of the Breaker

**CONTROL/POWER SOURCE:**  
RSO-IV-M18

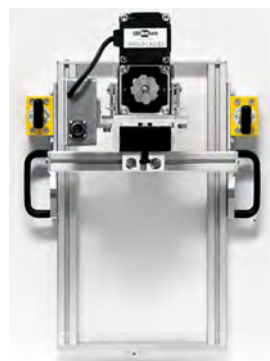

\*All unit measurements are L x W x H

# RRS-3

## LAR1

FOR USE WITH:  
**Allis-Chalmers/Siemens-Allis  
Air Circuit Breaker**

### SPECIFICATIONS

WEIGHT: 6.7 lbs.

DIMENSIONS:\* 12.9" x 5.8" x 4.0"

COMPATIBLE WITH: Type LA, LAF (All Sizes)

CONTROL/POWER SOURCE:  
Milwaukee M18 RedLithium Ion



# RRS-3

## LK

FOR USE WITH:  
**ABB/BBC/ITE  
Air Circuit Breaker**

### SPECIFICATIONS

WEIGHT: 18.5 lbs.

DIMENSIONS:\* 15.75" x 12.0" x 10.0"

COMPATIBLE WITH: Type LK  
(includes LK, LKD, LKE - 8, 16, 20, 25, 32, 40, 42)

CONTROL/POWER SOURCE:  
RSO-IV-M18

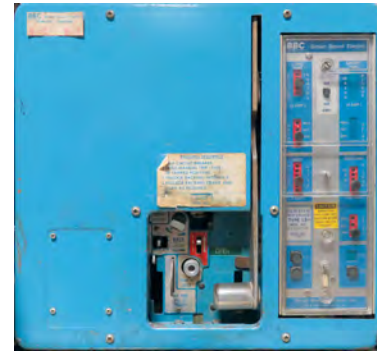
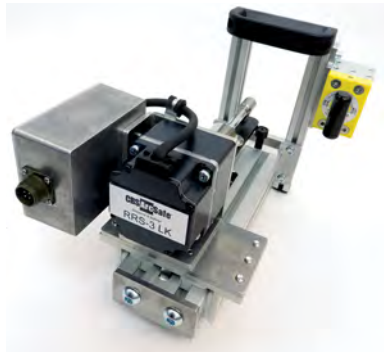

# RRS-3

## LS ACB

FOR USE WITH:  
**LS Air Circuit Breaker**



### SPECIFICATIONS

WEIGHT: 32.0 lbs.

DIMENSIONS:\* 15.0" x 15.4" x 22.0"

COMPATIBLE WITH: Types D, E, and G

CONTROL/POWER SOURCE:  
RSO-IV-M18



\*All unit measurements are L x W x H

# RRS-3

## LS VCB VH

FOR USE WITH:

**LS**  
**Vaccum Circuit Breaker**



### SPECIFICATIONS

WEIGHT: 19.0 lbs.

DIMENSIONS:\* 11.0" x 13.0" x 8.2"

COMPATIBLE WITH: Type VCB  
VH

CONTROL/POWER SOURCE:  
RSO-IV-M18



# RRS-3

## LS VCB VL

FOR USE WITH:

**LS**  
**Vaccum Circuit Breaker**



### SPECIFICATIONS

WEIGHT: 19.5 lbs.

DIMENSIONS:\* 11.3" x 11.4" x 8.2"

COMPATIBLE WITH: LS VCB VL

CONTROL/POWER SOURCE:  
RSO-IV-M18



# RRS-3

## MB II

FOR USE WITH:

**General Electric**  
**Vacuum/Air Circuit Breaker**

### SPECIFICATIONS

WEIGHT: 12.0 lbs.

DIMENSIONS:\* 6.4 x 5.3 x 9.9"

COMPATIBLE WITH: Magne-Blast  
Type AM (includes AM - 4.16, 5,  
7.2, 13.8, 15 with Clip-in Elevating  
Motor)

CONTROL/POWER SOURCE:  
RSO-IV-M18



\*All unit measurements are L x W x H

# RRS-3

## MDS

FOR USE WITH:

**Eaton/Cutler-Hammer  
Air Circuit Breaker**

### SPECIFICATIONS

WEIGHT: 22.0 lbs.

DIMENSIONS:\* 18.3" x 17.8" x 12.4"

COMPATIBLE WITH Type Magnum DS, Magnum SB, Magnum MW (MWI and MWN), 800-5000 A (includes MDS 08, 16, 20, 30, 32, 40, 50)

CONTROL/POWER SOURCE:  
RSO-IV-M18



# RRS-3

## MDSR1

FOR USE WITH:

**Eaton/Cutler-Hammer  
Air Circuit Breaker**



### SPECIFICATIONS

WEIGHT: 35.0 lbs.

DIMENSIONS:\* 12.1" x 4.6" x 4.5"

COMPATIBLE WITH: Type Magnum DS, Magnum SB door closed, 800-4000 A, Magnum MW (MWI and MWN)

CONTROL/POWER SOURCE:  
Milwaukee M18 RedLithium Ion



# RRS-3

## MP/MC

FOR USE WITH:

**Merlin Gerin/Schneider Electric  
Air Circuit Breaker**

### SPECIFICATIONS

WEIGHT: 23.8 lbs.

DIMENSIONS:\* 15.8" x 19.7" x 12.9"

COMPATIBLE WITH: Type Masterpact MP, MC, 800-6000 A (includes MP, MC 08, 12, 16, 20, 25, 30, 32, 40, 50, 63)

CONTROL/POWER SOURCE:  
RSO-IV-M18



\*All unit measurements are L x W x H

# RRS-3

## NRX(L)

FOR USE WITH:  
**Eaton/Cutler-Hammer  
Insulated Case Circuit Breaker**



### SPECIFICATIONS

**WEIGHT:** 25.0 lbs.

**DIMENSIONS:**\* 13.0" x 22.6" x 20.0"

**COMPATIBLE WITH:** Power Defense ICCB NRX RF-Frame Drawout Style; RF-Frames Come in 800, 1200, 1600, 2000, 2500, and 3000 A Frame Sizes for UL Ratings

**CONTROL/POWER SOURCE:**  
RSO-IV-M18

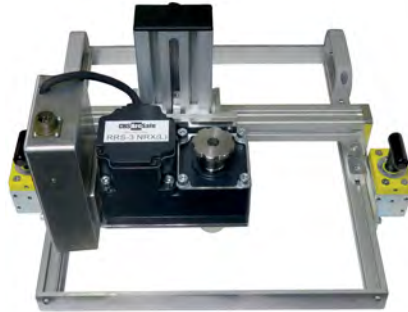

# RRS-3

## NRX(S)

FOR USE WITH:  
**Eaton/Cutler-Hammer  
Insulated Case Circuit Breaker**



### SPECIFICATIONS

**WEIGHT:** 30.0 lbs.

**DIMENSIONS:**\* 13.5" x 25.0" x 15.3"

**COMPATIBLE WITH:** Power Defense ICCB NRX NF-Frame Drawout Style; NF-Frames Come in 800-1200 A Frame Sizes for UL Ratings and 630, 800, 1000, 1250, and 1600 A Frame Sizes for IEC Ratings

**CONTROL/POWER SOURCE:** RSO-IV-M18

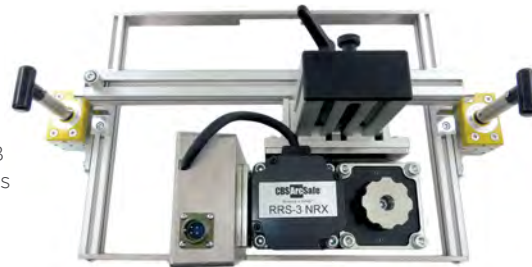

# RRS-3

## NT

FOR USE WITH:  
**Merlin Gerin/Schneider Electric/Square D  
Air Circuit Breaker**

### SPECIFICATIONS

**WEIGHT:** 20.4 lbs.

**DIMENSIONS:**\* 14.6" x 16.9" x 11.1"

**COMPATIBLE WITH:** Masterpact Type NT, 800-1600 A (includes NT 08, 10, 12, 16)

**CONTROL/POWER SOURCE:**  
RSO-IV-M18



\*All unit measurements are L x W x H

# RRS-3

## NW

FOR USE WITH:

**Merlin Gerin/Schneider Electric/Square D  
Air Circuit Breaker**



### SPECIFICATIONS

WEIGHT: 26.3 lbs.

DIMENSIONS:\* 15.8" x 19.7" x 12.9"

**COMPATIBLE WITH:**

MasterpactType NW, 800-6000 A (includes NW 08, 16, 20, 30, 40, 50, 60).

**CONTROL/POWER SOURCE:**

RSO-IV-M18



# RRS-3

## PB-I(L)

FOR USE WITH:

**General Electric Insulated  
Case Circuit Breaker**



### SPECIFICATIONS

WEIGHT: 25.0 lbs.

DIMENSIONS:\* 9.6" x 20.0" x 21.8"

**COMPATIBLE WITH:** Type PowerBreak I 3000 A and Above; Racking Mechanism on Left Side

**CONTROL/POWER SOURCE:**

RSO-IV-M18



# RRS-3

## PBII(S)

FOR USE WITH:

**General Electric Insulated  
Case Circuit Breaker**

### SPECIFICATIONS

WEIGHT: 16.0 lbs.

DIMENSIONS:\* 10.6" x 12.0" x 18.0"

**COMPATIBLE WITH:** Type PowerBreak II 2500 A and Below; Open-Door Application

**CONTROL/POWER SOURCE:**

RSO-IV-M18



\*All unit measurements are L x W x H

# RRS-3

## PowIVac (CDR)

FOR USE WITH:  
**Powell Vacuum  
Circuit Breaker**

### SPECIFICATIONS

**WEIGHT:** 34.3 lbs.

**DIMENSIONS:**\* 10.8" x 14.0" x 7.3"

**COMPATIBLE WITH:** PowIVac Type PV, 1200-3000 A (Closed-Door Racking [CDR] Only; Not Compatible with Breakers Equipped with Standard Circuit Breaker [STD])

**CONTROL/POWER SOURCE:**  
RSO-IV-M18



# RRS-3

## PowIVac (L)

FOR USE WITH:  
**Powell Vacuum  
Circuit Breaker**



### SPECIFICATIONS

**WEIGHT:** 20.0 lbs.

**DIMENSIONS:**\* 11.8" x 11.6" x 10.6"

**COMPATIBLE WITH:** PowIVac Closed-Door Application with Racking Mechanism Above Breaker; 27 kV and 38 kV

**CONTROL/POWER SOURCE:**  
RSO-IV-M18



# RRS-3

## PowIVac (STD)

FOR USE WITH:  
**Powell Vacuum  
Circuit Breaker**

### SPECIFICATIONS

**WEIGHT:** 19.0 lbs.

**DIMENSIONS:**\* 12.0" x 7.2" x 14.0"

**COMPATIBLE WITH:** PowIVac Type PV, 1200-3000 A (Standard Circuit Breaker [STD] Only; Not Compatible with Breakers Equipped with Closed-Door Racking [CDR])

**CONTROL/POWER SOURCE:**  
RSO-IV-M18



\*All unit measurements are L x W x H

# RRS-3

## PSD

FOR USE WITH:

**McGraw-Edison/North American Switchgear  
Air Circuit Breaker**

### SPECIFICATIONS

WEIGHT: 17.8 lbs.

DIMENSIONS:\* 11.1" x 11.6" x 20.0"

COMPATIBLE WITH: Type PSD 5 kV, 150, 250 MVA, 1200 A

CONTROL/POWER SOURCE: RSO-IV-M18



# RRS-3

## RLR1

FOR USE WITH:

**Siemens/Siemens-Allis  
Air Circuit Breaker**

### SPECIFICATIONS

WEIGHT: 6.8 lbs.

DIMENSIONS:\* 12.6" x 5.8" x 4.0"

COMPATIBLE WITH: Type RL, RLE, RLF (All Sizes); Not Compatible with Legacy Gear

CONTROL/POWER SOURCE: Milwaukee M18 RedLithium Ion



# RRS-3

## SB(1)

FOR USE WITH:

**Westinghouse Insulated  
Case Circuit Breaker**

### SPECIFICATIONS

WEIGHT: 17.0 lbs.

DIMENSIONS:\* 10.8" x 22.2" x 16.2"

COMPATIBLE WITH: Type SB 400, 800, and 1200 A Frame Sizes

CONTROL/POWER SOURCE: RSO-IV-M18



\*All unit measurements are L x W x H

# RRS-3

## SDR1

FOR USE WITH:  
**Schneider Electric/Square D  
Motor Control Center**

### SPECIFICATIONS

WEIGHT: 2.9 lbs.

DIMENSIONS:\* 7.8" x 3.0" x 3.0"

COMPATIBLE WITH: Model 6 MCC  
with Closed-Door Racking Feature

CONTROL/POWER SOURCE:  
120 V AC



# RRS-3

## SecoVac (IEEE)

FOR USE WITH:  
**General Electric  
Vacuum Circuit Breaker**

### SPECIFICATIONS

WEIGHT: 28.5 lbs.

DIMENSIONS:\* 9.1" x 18.1" x 24.1"

COMPATIBLE WITH: Type  
SecoVac VB2+ (IEEE Breaker,  
Switchgear Only, Closed Door,  
includes 5-15 kV, 1200-3000 A)

CONTROL/POWER SOURCE:  
RSO-IV-M18



# RRS-3

## SecureConnect

FOR USE WITH:  
**Allen-Bradley  
Motor Control Center**

### SPECIFICATIONS

WEIGHT: 13.0 lbs.

DIMENSIONS:\* 7.5" x 12.0" x 9.5"

COMPATIBLE WITH:  
CENTERLINE 2100 MCC with the  
SecureConnect Option



\*All unit measurements are L x W x H

# RRS-3 Selpact

FOR USE WITH:  
**Merlin Gerin/Schneider Electric  
Air Circuit Breaker**

## SPECIFICATIONS

WEIGHT: 22.0 lbs.

DIMENSIONS:\* 13.8" x 21.0" x 8.2"

COMPATIBLE WITH: Selpact  
1600, 2000, 2500, 3200 A  
(includes DN2, DN2-H, DS2, DS2-  
H, DR2, DRS2)

CONTROL/POWER SOURCE:  
RSO-IV-M18



# RRS-3 TemPower2(3)

FOR USE WITH:  
**Terasaki Insulated  
Case Circuit Breaker**



## SPECIFICATIONS

WEIGHT: 30.0 lbs.

DIMENSIONS:\* 14.4" x 18.6" x 16.0"

COMPATIBLE WITH: TemPower2  
ICCB (Dorman-Smith Loadline  
Z-Frame Series) 3-Pole Only to  
include Types: AR325S, AR332S,  
AR440SB, AR316H, AR320H,  
AR325H, and AR332H

CONTROL/POWER SOURCE:  
RSO-IV-M18



# RRS-3 Terasaki AT

FOR USE WITH:  
**Terasaki Insulated  
Case Circuit Breaker**



## SPECIFICATIONS

WEIGHT: 32.5 lbs.

DIMENSIONS:\* 13.8" x 14.4" x 17.5"

COMPATIBLE WITH: Tempro AT;  
Not Compatible with AT-40

CONTROL/POWER SOURCE:  
RSO-IV-M18



\*All unit measurements are L x W x H

# RRS-3 VAD 3/4/5

FOR USE WITH:  
**Square D Vaccum  
Circuit Breaker**



## SPECIFICATIONS

**WEIGHT:** 20.0 lbs.

**DIMENSIONS:**\* 13.4" x 6.3" x 13.9"

**COMPATIBLE WITH:** VAD-3/  
VAD-4/VAD-5 Breakers in Square  
D Switchgear Built for Open-Door  
Racking

**CONTROL/POWER SOURCE:**  
RSO-IV-M18



# RRS-3 VB

FOR USE WITH:  
**General Electric  
Vacuum Circuit Breaker**



## SPECIFICATIONS

**WEIGHT:** 19.9 lbs.

**DIMENSIONS:**\* 14.1" x 6.3" x 14.4"

**COMPATIBLE WITH:** Type VB,  
1200-3000 A (includes VB-4.16,  
VB-7.2, VB-13.8)

**CONTROL/POWER SOURCE:**  
RSO-IV-M18



# RRS-3 VCP

FOR USE WITH:  
**Westinghouse  
Vacuum Circuit Breaker**

## SPECIFICATIONS

**WEIGHT:** 19.0 lbs.

**DIMENSIONS:**\* 8.3" x 11.7" x 14.2"

**COMPATIBLE WITH:** Type VCP,  
1200-3000 A (includes 50 VCP,  
75 VCP, 150 VCP)

**CONTROL/POWER SOURCE:**  
RSO-IV-M18



\*All unit measurements are L x W x H

# RRS-3

## VCP-W(L)

FOR USE WITH:

**Cutler-Hammer/Eaton/  
Westinghouse  
Vacuum Circuit Breaker**

### SPECIFICATIONS

WEIGHT: 19.6 lbs.

DIMENSIONS:\* 7.4" x 13.5" x 9.9"

COMPATIBLE WITH: Type  
380VCP-W40 Large Breaker  
(Open-Door Racking)

CONTROL/POWER SOURCE:  
RSO-IV-M18

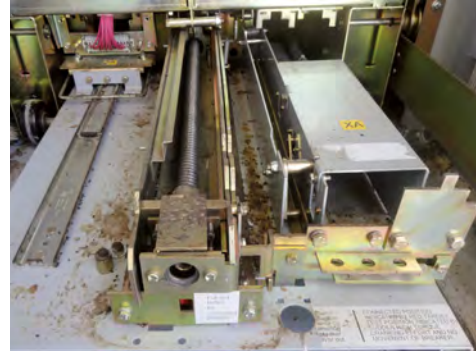

# RRS-3

## VCP-W(S)

FOR USE WITH:

**Cutler-Hammer/Eaton/  
Westinghouse  
Vacuum Circuit Breaker**

### SPECIFICATIONS

WEIGHT: 20.7 lbs.

DIMENSIONS:\* 9.5" x 14.7" x 10.0"

COMPATIBLE WITH: Type VCP-W,  
1200-3000 A (includes 50 VCP-  
W, 75 VCP-W, 150 VCP-W)

CONTROL/POWER SOURCE:  
RSO-IV-M18



# RRS-3

## VCPR

FOR USE WITH:

**Cutler-Hammer/Eaton/Westinghouse  
Vacuum Circuit Breaker**

### SPECIFICATIONS

WEIGHT: 8.1 lbs.

DIMENSIONS:\* 11.0" x 6.5" x 5.5"

COMPATIBLE WITH: Type VCP-W

CONTROL/POWER SOURCE:  
Milwaukee M18 RedLithium Ion



\*All unit measurements are L x W x H

# RRS-3

## VH

FOR USE WITH:

**General Electric  
Vacuum Circuit Breaker**

### SPECIFICATIONS

WEIGHT: 39.0 lbs.

DIMENSIONS:\* 20.6" x 28.0" x 12.7"

COMPATIBLE WITH: Type VH

CONTROL/POWER SOURCE:  
RSO-IV-M18



# RRS-3

## VK-VH1

FOR USE WITH:

**Toshiba Vacuum  
Circuit Breaker**



### SPECIFICATIONS

WEIGHT: 25.0 lbs.

DIMENSIONS:\* 11.6" x 16.6" x 9.8"

COMPATIBLE WITH: Type VK  
Circuit Breakers with Racking  
Mechanism in TAMCO VH1  
Switchgear

CONTROL/POWER SOURCE:  
RSO-IV-M18

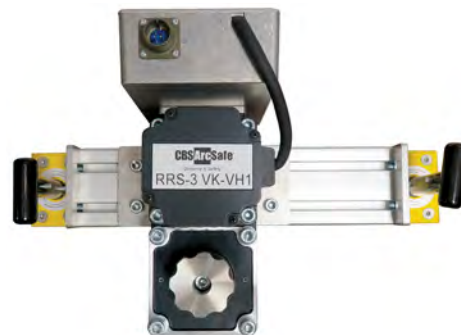

# RRS-3

## Vmax

FOR USE WITH:

**ABB  
Vacuum Circuit Breaker**

### SPECIFICATIONS

WEIGHT: 19.9 lbs.

DIMENSIONS:\* 14.1" x 6.3" x 11.4"

COMPATIBLE WITH: Type Vmax,  
600-2000 A (includes Vmax, L 12,  
17; Vmax, W 12, 17)

CONTROL/POWER SOURCE:  
RSO-IV-M18





# Remote Switch Operators



CBS ArcSafe remote switch operators (**RSOs**) enable service personnel to stand outside the arc-flash protection boundary while operating electrical equipment, which reduces or eliminates the need for a full-body arc-flash hazard suit. Our RSOs can be used in conjunction with the CBS ArcSafe remote racking system or independently as a stand-alone device.



RSO: US PATENT NO. 8,006,371B1

Compatible with all switchgear manufacturers, including:

- |                         |                                   |                        |                       |
|-------------------------|-----------------------------------|------------------------|-----------------------|
| ■ <b>ABB</b>            | ■ <b>Eaton</b>                    | ■ <b>ITE</b>           | ■ <b>Toshiba</b>      |
| ■ <b>Allis-Chalmers</b> | ■ <b>Federal Pacific Electric</b> | ■ <b>Siemens</b>       | ■ <b>Westinghouse</b> |
| ■ <b>BBC</b>            | ■ <b>Federal Pioneer</b>          | ■ <b>Siemens-Allis</b> |                       |
| ■ <b>Cutler-Hammer</b>  | ■ <b>General Electric</b>         | ■ <b>Square D</b>      |                       |

NOTE: All manufacturers' names, trademarks, and part numbers are used for reference purposes only. CBS ArcSafe, Inc., is not an authorized distributor or representative of manufacturers shown. Designated trademarks, brand names, and brands appearing herein are the property of their respective owners.

**POWERED BY**  
**M18 REDLITHIUM**

## RSO-IAR-M18

The RSO-IAR-M18 operator is a rechargeable 24 V DC power supply that, when used in conjunction with the appropriate RSA, will remotely perform any switching procedure that normally would require local operation by trained personnel. Common tasks the RSOs and RSAs can perform include, but are not limited to:

1. Operating push-buttons, such as circuit breaker trip and close buttons
2. Operating levers, such as those found on motor control center buckets
3. Operating charging handles requiring single strokes
4. Operating rotary and pistol-grip switches, such as breaker control switches



## RSO-IIID-M18

The RSO-IIID-M18 operator is a rechargeable 24 V DC power supply that, when used in conjunction with the appropriate RSA, will remotely operate any switching or control operation that normally would require local operation by trained personnel. Common tasks the RSOs and RSAs can perform include, but are not limited to:

1. Operating push-buttons, such as circuit breaker trip and close buttons
2. Operating charging handles requiring single or multiple cycles
3. Engaging or disengaging mechanical interlocks, such as circuit breaker interlock foot pedals



## RSO-IV-M18

The RSO-IV-M18 operator is a rechargeable 24 V DC power supply that, when used in conjunction with an appropriate apparatus-specific remote racking system (RRS-3), will remotely perform any racking operation that would normally require local operation by trained personnel. The RSO-IV-M18 features a new blue indicator beacon that alerts users when input settings have been reached. Tasks the RSOs and RRS-3s can perform include, but are not limited to:

1. Installing and removing any switchgear using a rotary racking mechanism
2. Installing and removing any switchgear using a nonrotary racking mechanism
3. Engaging or disengaging mechanical or electrical interlocks, such as circuit breaker interlock foot pedals or buttons



# Remote Switch Actuators



CBS ArcSafe® remote switch actuators (RSAs) are designed to remotely charge, close, and/or trip various styles and types of electrical equipment. We can custom build RSAs for any electrical device.

The devices are assisted by strong magnets, requiring no modifications to your switchgear. This also allows operators to easily move the RSA from one breaker to another.

Each CBS ArcSafe RSA is custom built to your electrical equipment so that it can safely operate outside the arc-flash boundary.

## OPTIONAL FEATURES

- Radio remote with up to 300-ft. range
- 24 V DC LED light
- Wireless video camera system with LCD monitor
- Rugged protective case assembly

## BENEFITS

- Lightweight, portable construction
- Mechanical and/or electrical safety protection
- Adjustable to fit unique electrical equipment configurations
- Fast and easy to set up
- Reduced need for a full-body arc-flash suit
- Adds safety and helps comply with NFPA 70E
- No modifications required

**RSO-IAR-M18 & RSA-113G**



**RSA-2HD**



**RSA-29**



**RSA-2**

Compatible with all switchgear manufacturers, including:

- |                         |                                   |                           |                             |
|-------------------------|-----------------------------------|---------------------------|-----------------------------|
| ■ <b>ABB</b>            | ■ <b>Controlled Power</b>         | ■ <b>General Electric</b> | ■ <b>Reyrolle</b>           |
| ■ <b>AEG</b>            | ■ <b>Cutler-Hammer</b>            | ■ <b>Hyundai</b>          | ■ <b>Schneider Electric</b> |
| ■ <b>Allis-Chalmers</b> | ■ <b>Eaton</b>                    | ■ <b>ITE</b>              | ■ <b>Siemens</b>            |
| ■ <b>Alstom</b>         | ■ <b>Federal Pacific Electric</b> | ■ <b>McGraw-Edison</b>    | ■ <b>Siemens-Allis</b>      |
| ■ <b>Areva</b>          | ■ <b>Federal Pioneer</b>          | ■ <b>Merlin Gerin</b>     | ■ <b>Square D</b>           |
| ■ <b>Asea</b>           | ■ <b>Fuji</b>                     | ■ <b>Mitsubishi</b>       | ■ <b>Toshiba</b>            |
| ■ <b>BBC</b>            | ■ <b>GEC</b>                      | ■ <b>Powell</b>           | ■ <b>Westinghouse</b>       |

NOTE: All manufacturers' names, trademarks, and part numbers are used for reference purposes only. CBS ArcSafe, Inc., is not an authorized distributor or representative of manufacturers shown. Designated trademarks, brand names, and brands appearing herein are the property of their respective owners.

# Manufacturer Index

MANUFACTURER/EQUIPMENT	RSA/RSK NUMBER	PAGE	MANUFACTURER/EQUIPMENT	RSA/RSK NUMBER	PAGE
ABB ADVAC or RMVAC MV Retrofit for 5 or 15 kV Breakers	RSA-283	225	ABB/Siemens Flange Handle Operator K7FCH/K7FCH4 & Max-Flex Handle Operator MFHM Series	RSA-163	185
ABB Handle Operator OHY/OHB/OHG	RSA-192E	204	ABB/Siemens Flange Handle Operator K7FCH/K7FCH4 & Max-Flex Handle Operator MFHM Series	RSA-163D	186
ABB MCCB N Frame 1200 A Frame Size	RSA-111E	153	ABB/Siemens Flange Handle Operator K7FHD-HS12/K7FHD-HS4	RSA-163A	185
ABB MCCB P Frame 1600/2000/2500 A Frame Size	RSA-111F	153	ABB/Siemens Flange Handle Operator OHF1C4, OHF1C12	RSA-163C	186
ABB Rotary Handle Operator, Variable Depth, Square Type 1 K2VD-H for ABB Isomax S1 Frame MCCB	RSA-198	205	All Manufacturers, Push Button	RSA-2	82
ABB Rotary Handle Operator, Variable Depth, Square Type 1 K5VD-H for ABB Isomax S3/S4/S5 Frame MCCB & K7VD-H for ABB Isomax S6/S7 Frame MCCB, Direct Mount, Rotary Handle Operating Mechanism K5RH for ABB Isomax S3/S4/S5 Frame MCCB	RSA-198A	206	All Manufacturers, Push Button	RSA-2B	82
ABB SF6 CB HGI 2/HGI 3 Generator 17.5-24 kV 6300-8000 A	RSA-202	207	All Manufacturers, Push Button	RSA-2D	83
ABB/BBC/ITE ACB K-Line	RSA-30	99	All Manufacturers, Push Button	RSA-2HD	83
ABB/BBC/ITE ACB K-Line	RSA-30A	99	Allen Bradley CENTERLINE 2100 and Bulletin 1200 MCC Main Buckets with Large Handles	RSK-ABL2W	233
ABB/BBC/ITE ACB K-Line	RSK-K15	240	Allen-Bradley CENTERLINE 2100 Handle Operator 5kV Starter (2nd generation, recessed mount, red/black plastic handle operator)	RSA-71C	129
ABB/BBC/ITE ACB K-Line	RSK-K20	240	Allen-Bradley CENTERLINE 2100 MCC 5kV Starter (1st generation, gray metal handle operator)	RSA-71	128
ABB/BBC/ITE ACB K-Line/K Don	RSA-30B	100	Allen-Bradley CENTERLINE 2100 MCC 5kV Starter (2nd generation, flush mount, red/black plastic handle operator)	RSA-71B	129
ABB/BBC/ITE ACB K-Line/K Don	RSA-30C	100	Allen-Bradley CENTERLINE 2100 MCC Bucket Size 1-4	RSA-41	105
ABB/BBC/ITE ACB Type LK	RSA-114	157	Allen-Bradley CENTERLINE 2100 MCC Bucket Size 5	RSA-41A	105
ABB/BBC/ITE ACB Type LK	RSA-114A	157	Allen-Bradley CENTERLINE 2100 MCC Horizontal Bucket Size 1	RSA-41C	106
ABB/BBC/ITE ACB Type LK25 2500 A	RSK-BBC5	235	Allen-Bradley CENTERLINE 2100 MCC Main	RSA-41B	106
ABB/BBC/ITE ACB Type MB	RSA-115	158	Allen-Bradley CENTERLINE 2100 MCC Size 1-4 Bucket	RSA-47	111
ABB/BBC/ITE ACB Type MB	RSA-115A	158	Allen-Bradley CENTERLINE 2100 MCC Size 1-4 Bucket	RSA-47B	111
ABB/BBC/ITE MCC 7850 Series Medium-Voltage Motor Starter	RSA-150	176	Allen-Bradley CENTERLINE 2100 MCC Size 5 Bucket & 5 kV Starter	RSA-47A	111
ABB/BBC/ITE Type HK-HPL-C Drawout Interrupter Switch	RSA-65A	125	Allen-Bradley CENTERLINE 2100 MCC Sizes 1-4 Bucket (Black or Gray Plastic Handle)(LVMCC)	RSK-ABLIW	233
ABB/BBC/ITE VersaRupter LIS/HK-HPL-C Drawout Interrupter Switch	RSA-65	125	Allen-Bradley MCC 1494F-P1-NP Series A Nonmetallic Molded Plastic Operating Handle	RSA-167	191
ABB/ITE/BBC HK Style With Hook Latch Close and Push Button Trip	RSA-269	220	Allis-Chalmers/Siemens-Allis ACB Type LA/LAF 1600-2000 A	RSK-LA12	241
ABB/SACE ACB Type E3S-A	RSK-SACE1	243	Allis-Chalmers/Siemens-Allis LIS Type SE	RSA-138	172
ABB/SACE ACB Type S 1600	RSK-SACE2	244	Allis-Chalmers/Siemens-Allis LIS Type SE2/SG 3328 or QB 5/15 kV Metal Enclosed Switch	RSA-138A	172
ABB/SACE ICCB Emax E1, E2, E3, E4, E5, E6	RSA-96A	144	Allis-Chalmers/Siemens-Allis LIS Type SE4 or QB 5/15 kV Metal Enclosed Switch	RSA-138B	173
ABB/SACE ICCB Emax Low-Voltage Power CB 800-6000 A, All Sizes & Tmax MCCBs 1600-3000 A	RSA-96	144	Allis-Chalmers/Siemens-Allis/Siemens ACB LA/LAF 1600-2000 A	RSA-105E	152
ABB/SACE ICCB Emax2, 1.2	RSA-96C	144	Allis-Chalmers/Siemens-Allis/Siemens ACB LA/LAF 3000 A	RSA-105D	151
ABB/SACE ICCB Emax2, 2.2, 4.2, 6.2	RSA-96D	145	Allis-Chalmers/Siemens/Siemens-Allis ACB Charge Assembly Type LA/LAF 3000-4000 A	RSA-105A	150
ABB/SACE ICCB Emax2, 2.2, 4.2, 6.3	RSA-96E	145	Allis-Chalmers/Siemens/Siemens-Allis ACB Close/Trip Assembly Type LA/LAF 3000-4000 A	RSA-105A	150
ABB/SACE ICCB Megamax F F3-F6 C/C/T	RSA-69C	128	Allis-Chalmers/Siemens/Siemens-Allis ACB Type FA/FB/FC	RSA-17	92
ABB/SACE ICCB Megamax F F3-F6 C/T	RSA-69D	128	Allis-Chalmers/Siemens/Siemens-Allis ACB Type LA/LAF 1600-2000 A	RSA-105	150
ABB/SACE ICCB Megamax F Low-Voltage Power Circuit Breaker 1200-6000 A, All Sizes	RSA-69A	127	Allis-Chalmers/Siemens/Siemens-Allis ACB Type LA/LAF 3000-4000 A	RSA-105C	151
ABB/SACE Isomax MCCB Size S7 1200 A Frame	RSA-145E	174	Allis-Chalmers/Siemens/Siemens-Allis ACB Type LA/LAF 600-800 A	RSA-105B	151
ABB/SACE Novamax ACB (All)	RSA-242	216			
ABB/SACE Tmax MCCB Size T7 1000-1600 A Frame	RSA-174F	194			
ABB/SACE Tmax MCCB Size T7M 1000/1200 A Frame	RSA-174E	194			
ABB/SACE Tmax XT1 Frame, 125 A Flush Mounted	RSA-287	226			
ABB/SACE Tmax XT5 Frame, 400-600 A, Flush Mounted	RSA-287D	226			
ABB/SACE Tmax XT6 Frame, Withdrawable MCCB, 800 A, Flush Mounted	RSA-287E	226			

See individual listings for more specific breaker compatibility descriptions.

MANUFACTURER/EQUIPMENT	RSA/RSK NUMBER	PAGE	MANUFACTURER/EQUIPMENT	RSA/RSK NUMBER	PAGE
Allis-Chalmers/Siemens/Siemens-Allis ACB Type LA/LAF 600-800 A	RSA-105F	152	Cutler-Hammer/Eaton MCCB Series G LG Frame 100-630 A 240-600 V AC 1-4 Pole, Flush Mounted, includes LG/LGE/LGS/LGH/LGC/LGU/LGX	RSA-230B	215
Allis-Chalmers/Siemens/Siemens-Allis LIS Spacemaker/ Spacemaker II Type 456 Contactor	RSA-139	173	Cutler-Hammer/Eaton Type SM Safety Handle Mechanism for MCCB Series C L Frame	RSA-221C	212
Bentek 1500 V UTS2 for 1500 VDC Integrated Disconnect String Combiner for Grounded PV Systems, 200-400 A	RSA-282	225	Cutler-Hammer/Eaton Universal Rotary Handle Mechanism for MCCB Series C/G	RSA-227	214
Bulldog/ITE/Siemens General Duty Enclosed Safety Switch	RSA-205	209	Cutler-Hammer/Eaton/Pringle Bolted Pressure Switch QA 1200-2500 A; Legacy Vintage; Straight Handle Only, without Shunt Trip, 115° of Handle Travel, 28"-32" Min. Cubicle Width	RSA-135E	168
Challenger HDN365 Safety Switch 400 A	RSA-277	223	Cutler-Hammer/Eaton/Pringle Bolted Pressure Switch QA 1200-2500 A; Legacy Vintage; Straight Cast Aluminum Only, without Shunt Trip, 115° of Handle Travel, 28"-32" Min. Cubicle Width	RSA-135H	169
Clark/Sylvania 6200 MCC Bucket	RSA-99	146	Cutler-Hammer/Eaton/Pringle Bolted Pressure Switch QA 800 A Only; Current Vintage; Straight Handle Only, without Shunt Trip, 90° of Handle Travel, 24" Min. Cubicle Width	RSA-135D	168
Clark/Sylvania/Zinsco/FPE QSF Series & 5310/5320/5325 MCC Bucket	RSA-103A	149	Cutler-Hammer/Eaton/Pringle Bolted Pressure Switch QA 800 A Only; Legacy Vintage; Straight Cast Aluminum Only, without Shunt Trip, 115° of Handle Travel, 28"-32" Min. Cubicle Width	RSA-135G	169
Clark/Sylvania/Zinsco/FPE QSF Series Panelboard Switch 100-600 A	RSA-103	149	Cutler-Hammer/Eaton/Pringle Bolted Pressure Switch QA Above 2500 A; Current Vintage; Straight Handle Only, without Shunt Trip, 115° of Handle Travel, 44" Min. Cubicle Width	RSA-135F	169
Continental LVMCC Size 1-4 Close/Trip Actuator, Small Handle	RSA-278	223	Cutler-Hammer/Eaton/Pringle Bolted Pressure Switch QA Above 2500 A; Legacy Vintage; Straight Cast Aluminum Only, without Shunt Trip, 115° of Handle Travel, 44" Min. Cubicle Width	RSA-135I	170
Cooper Substation VFI Transformer	RSA-157	181	Cutler-Hammer/Eaton/Pringle Bolted Pressure Switch QA-CBC 2500 A & Below; Current Vintage; Straight Handle Only, with Shunt Trip, 90° of Handle Travel, 28"-32" Min. Cubicle Width	RSA-135	167
Cooper Type CM Fault Interrupter	RSA-272	222	Cutler-Hammer/Eaton/Pringle Bolted Pressure Switch QA-CBC Above 2500 A; Current Vintage; Straight Handle Only, with Shunt Trip, 90° of Handle Travel, 44" Min. Cubicle Width	RSA-135A	168
Cutler-Hammer 9800 Unitrol Size 1-4 MCC Bucket	RSA-89	139	Cutler-Hammer/Square D/Westinghouse ACB Type DS (All)	RSA-12A	89
Cutler-Hammer 9800 Unitrol Size 5 MCC Bucket	RSA-89A	139	Cutler-Hammer/Square D/Westinghouse ACB Type DS (All)	RSA-12B	89
Cutler-Hammer Bolted Pressure Switch Boltswitch Series T 400-1200 A	RSA-152G	177	Cutler-Hammer/Square D/Westinghouse ACB Type DS (All)	RSA-12C	89
Cutler-Hammer Bolted Pressure Switch Boltswitch SLB Series 600 V Pressure Contact Switch	RSA-152C	177	Cutler-Hammer/Square D/Westinghouse ACB Type DS (All)	RSK-DS10	238
Cutler-Hammer Bolted Pressure Switch Boltswitch VL3612-ST	RSA-152	177	Cutler-Hammer/Westinghouse MCC Ampguard Legacy Style Handle Operator	RSA-10	87
Cutler-Hammer Breaker Control Switch	RSA-1H	81	Cutler-Hammer/Westinghouse MCC Cutler-Hammer F2100, Advantage, Series 2100; Westinghouse 5 Star Size 1-5 MCC Bucket	RSA-78	134
Cutler-Hammer Control Switch Model L2R120CW	RSK-CS06	237	Cutler-Hammer/Westinghouse MCCB E/F Frame 10-150 A	RSA-20	93
Cutler-Hammer F10 Unitrol/9800 Unitrol MCC Size 1-4 Bucket Slider Style Operating Handle Mechanism	RSA-87	138	Cutler-Hammer/Westinghouse MCCB JB/KB/HKB Frame	RSA-20A	94
Cutler-Hammer F10 Unitrol/9800 Unitrol MCC Size 5 Bucket Slider Style Operating Handle Mechanism	RSA-87A	139	Cutler-Hammer/Westinghouse MCCB L Frame 125-600 A	RSA-20CR	95
Cutler-Hammer FDPW Fusible Panelboard Switch 30/60/100 A Twin	RSA-184	198	Cutler-Hammer/Westinghouse MCCB LA/LAB/HLA/LC Frame	RSA-20C	94
Cutler-Hammer FDPW Fusible Panelboard Switch 400 A Single	RSA-184D	199	Cutler-Hammer/Westinghouse MCCB MA/HMA Frame MC	RSA-20D	95
Cutler-Hammer FDPW Fusible Panelboard Switch 600/800 A Single	RSA-184F	199	Cutler-Hammer/Westinghouse MCCB NB/HNB Frame NC	RSA-20E	95
Cutler-Hammer FDPW Panelboard Switch 200 A Single	RSA-184C	198	Cutler-Hammer/Westinghouse MCCB PB Frame PA/PC	RSA-20F	96
Cutler-Hammer Freedom Unitrol	RSA-36A	103	Cutler-Hammer/Westinghouse Series C MCCB F Frame 10-225 A, White, Flush Mounted	RSA-113B	155
Cutler-Hammer LBS Type MVS	RSA-117A	160	Cutler-Hammer/Westinghouse Series C MCCB J Frame 70-250 A, White, Flush Mounted	RSA-113D	155
Cutler-Hammer MCC F10 Unitrol/9800 Unitrol Lever Size 1-4	RSA-189	204	Cutler-Hammer/Westinghouse Series C MCCB K Frame 70-400 A, White, Flush Mounted	RSA-113A	155
Cutler-Hammer/Eaton Handle Operator Series C Rotary Through-the-Door Handle Mechanism	RSA-42	106			
Cutler-Hammer/Eaton Handle Operator Vari-Depth Type Mech; NEMA Type 1, 3R, 12	RSA-40	105			
Cutler-Hammer/Eaton Heavy Duty Fusible/Nonfusible Low-Voltage Safety Switch	RSA-211A	211			
Cutler-Hammer/Eaton ICCB Type Magnum DS/SB	RSA-48	112			
Cutler-Hammer/Eaton ICCB Type Magnum DS/SB	RSK-MDS30	241			
Cutler-Hammer/Eaton Low-Voltage Pow-R-Way/Pow-R-Way II/Pow-R-Way III Busway System Plug-In Device IPB-MC 100-200 A Bus Plug	RSA-224	214			
Cutler-Hammer/Eaton MCC Ampguard Current Style Handle Operator	RSA-10A	87			

MANUFACTURER/EQUIPMENT	RSA/RSK NUMBER	PAGE	MANUFACTURER/EQUIPMENT	RSA/RSK NUMBER	PAGE
Cutler-Hammer/Westinghouse Series C MCCB L Frame 125-600 A, White, Recessed Mounted without Handle Extension	RSA-113I	156	Electros witch Control Switch Series 20	RSK-CS05	237
Cutler-Hammer/Westinghouse Series C MCCB M Frame 300-800 A, White, Flush Mounted	RSA-113E	156	Electros witch Control Switch Series 31, Common on Siemens RL Switchgear	RSK-CS07	238
Cutler-Hammer/Westinghouse Series C MCCB N Frame 400-1200 A, White, Flush Mounted with Handle Extension	RSA-113	154	Electros witch Series 20 Control Switch	RSK-CS04W	237
Cutler-Hammer/Westinghouse Series C MCCB R Frame 800-2500 A, White, Flush Mounted with Handle Extension	RSA-113G	156	Electros witch Series 24/24P; GE SB/SBM/SB-1/SB-9/SB-10; Type W, Shallco Series 26	RSK-CS01W	236
Cutler-Hammer/Westinghouse Series C MCCB R Frame 800-2500 A, White, Stand-Alone Mounted with Handle Extension	RSA-113J	157	Electros witch/GE/Westinghouse/ITI/Shallco Breaker Control Switch	RSA-1	79
Cutler-Hammer/Westinghouse Type F2100/Advantage/ Series 2100/5 Star MCC Main	RSA-78A	134	Electros witch/GE/Westinghouse/ITI/Shallco Breaker Control Switch	RSA-1E	80
Cutler-Hammer/Westinghouse Type FDP & M50 Fusible Panelboard Switch 30/60/100 A Twin	RSA-153A	178	Electros witch/Westinghouse Breaker Control Switch	RSA-1B	79
Cutler-Hammer/Westinghouse Type FDP & M50 Fusible Panelboard Switch 400/600 A Single	RSA-153D	178	Elliot Control Type 211 MVMCC	RSA-108	153
Cutler-Hammer/Westinghouse Type FDP & M50 Fusible Panelboard Switch 800/1200 A Single, 90° of Handle Travel, for Horizontal Unit, Switch Located On Middle Left-Hand Side	RSA-153F	178	Elliot MCC Type 230	RSA-107	152
Cutler-Hammer/Westinghouse/Eaton 11-300 MCC Bucket & MCCB Slide Plate Type Handle Mechanism	RSA-35	103	Elmex Disconnect Switch, Rotary 180-270°	RSA-294	228
Cutler-Hammer/Westinghouse/Eaton 11-300 MCC Bucket & MCCB Slide Plate Type Handle Mechanism	RSA-35B	103	Elmex Load Break Switch, Lever Style	RSA-295	228
Cutler-Hammer/Westinghouse/Eaton ICCB Type SPB Systems Pow-R 250-3000 A	RSK-SPB1	245	Engineering Intelligent Medium Powerbar Tap-off Disconnect Box Switch Type W-2	RSK-IMPB1	240
Cutler-Hammer/Westinghouse/Eaton ICCB Type SPB Systems Pow-R 250-3000 A	RSK-SPB2	246	FPE ACB H/HF-1 (All Sizes)	RSA-151B	176
Driescher and Wittjohann Driwisa LBS	RSA-63	124	FPE ACB Type DST-II	RSA-126	165
Eaton G-EG/JG/LG Universal Rotary Handle	RSA-271A	222	FPE ACB Type H-2/HL-2 & H-3/HL-3 Electric	RSA-112B	154
Eaton Heavy Duty Fusible/Non-Fusible Low Voltage Safety Switch 30 A	RSA-211	211	FPE ACB Type H-2/HL-2 & H-3/HL-3 Manual	RSA-112	154
Eaton NRX NF Frames 200-1200 A and IEC IZMX16 630 A, 800 A, 1000 A, 1250 A, 1600 A	RSA-265A	219	FPE ACB Type H/HF-1(All) Nonmagnetic Switchgear	RSA-151A	176
Eaton NRX RF Frames 1600-3000 A and IEC IZMX16 800 A, 1000 A, 1250 A, 1600 A, 2000 A, 2500 A, 3200 A, 4000 A	RSA-265B	220	FPE Autojet LIS 5-38 kV	RSA-132A	166
Eaton S01 Universal Rotary Handle	RSA-271	221	FPE Low-Voltage ACB 12/16/20/32/40PL for Nonmagnetic Switchgear	RSA-228	214
Eaton Type LBS	RSA-117B	161	FPE Low-Voltage Circuit Breaker S4/S5 30/50/75 (800-3200 A)	RSA-218A	212
Eaton-Moeller NZM4 Door Coupling Rotary Handle	RSA-279	224	FPE MCCB J Frame 70-225 A	RSA-175B	194
Eaton/Cutler Hammer Flex Shaft Flange Mounted Handle Mechanism (4" Handle, Stainless Steel Enclosure)	RSA-222D	213	FPE MCCB M Frame 150-800 A	RSA-175E	195
Eaton/Cutler Hammer Flex Shaft Flange Mounted Handle Mechanism (4" Handle)	RSA-222	213	FPE Panelboard Switch Heavy Duty Safety Switch 100 A/600 V	RSA-102C	148
Eaton/Cutler Hammer Flex Shaft Flange Mounted Handle Mechanism (8.25" Handle on Recessed Application)	RSA-222E	213	FPE Panelboard Switch Heavy Duty Safety Switch 600 A/600 V	RSA-102D	148
Eaton/Cutler Hammer/Westinghouse JLDN600, RLDN600, WLDN600, JNDN1200, RNDN1200, and WNDN1200 Circuit Breaker Enclosures, 600-1200 A, Not for Stainless Steel Enclosures	RSA-270	221	FPE Panelboard Switch Switchmatic Disconnect Switch QMQB Series 400 A	RSA-102	148
Eaton/Cutler-Hammer ICCB Type Magnum DS/SB	RSA-48C	112	FPE QMQB Panelboard Switch 200 A Single	RSA-177A	196
Eaton/Cutler-Hammer MCC Ampgard	RSA-10F	88	FPE QMQB Panelboard Switch 30-100 A Single or Twin	RSA-177	195
Eaton/Cutler-Hammer/Westinghouse 2100/Freedom/Five Star/Advantage Series LVMCC Sizes 1-4 Buckets	RSK-CHL1W	236	FPE QMQB Panelboard Switch 800-1200 A Single	RSA-177C	196
Eaton/Cutler-Hammer/Westinghouse HF361, HF322 Circuit Breaker Enclosure With Raised Face, Large Rubberized Handle, 100 A	RSA-270B	221	Furnas/Siemens-Furnas/Siemens System 89 MCC	RSA-83C	137
EBG Disconnect Switch, Rotary	RSA-292	227	Furnas/Siemens-Furnas/Siemens System 89 MCC	RSA-83D	137
Electros witch Breaker Control Switch	RSA-1A	79	Furnas/Siemens-Furnas/Siemens System 89 MCC Size 1-4 & TIASTAR	RSA-83	136
Electros witch Breaker Control Switch	RSA-1C	80	Furnas/Siemens-Furnas/Siemens System 89 MCC TiaStar Size 1-4	RSA-83A	137
			GE 7700 MCC Size 1-4 Bucket Handle Operator & Type TDR Integral Handle Mechanism	RSA-8	84
			GE 7700 MCC Size 5 Bucket Handle Operator & Type TDR Integral Handle Mechanism	RSA-8A	85
			GE 8000 MCC Size 1-4	RSA-46A	110
			GE 8000 MCC Size 1-4	RSA-46	109
			GE 8000 MCC Size 5 Bucket/Style Main Disconnect	RSA-46B	110
			GE ACB EntelliGuard G	RSA-162	184
			GE ACB EntelliGuard G 400-6000 A, GG/GJ/GH/GK-04/07/08/10/13/16/20/25/32/40/50/64	RSA-162A	185
			GE ACB Power Break	RSK-GEPB1	238

<b>MANUFACTURER/EQUIPMENT</b>	<b>RSA/RSK NUMBER</b>	<b>PAGE</b>	<b>MANUFACTURER/EQUIPMENT</b>	<b>RSA/RSK NUMBER</b>	<b>PAGE</b>
GE ACB Power Break	RSK-GEPBIE	239	GE Heavy Duty Safety Switches Listed in Drawing Number 10103091SH112, NEMA Type 1 enclosure, 400-600 A	RSA-169C	192
GE ACB Power Break	RSK-GEPBIL	239	GE Heavy-Duty Safety Switch TH Series	RSA-169A	192
GE ACB Power Break II	RSK-GEPB2	239	GE ICCB Power Break Electric 2500-4000 A	RSA-91A E	141
GE ACB Type AK 1600-3200 A	RSK-AK13	234	GE ICCB Power Break Electric 2500-4000 A	RSA-91C E	142
GE ACB Type AK-1-25	RSA-90	140	GE ICCB Power Break Electric 800-2000 A	RSA-91 E	140
GE ACB Type AK-1/2/3-25	RSA-29	98	GE ICCB Power Break II, All Frame Sizes	RSA-76	132
GE ACB Type AK-1/2/3-25 Close/Trip	RSA-29B	99	GE ICCB Power Break II, All Frame Sizes	RSA-76C	133
GE ACB Type AK-1/2/3(A)-50/75/100	RSA-18	92	GE ICCB Power Break II, All Frame Sizes	RSA-76E	133
GE ACB Type AK-1/2/3(A)-50/75/100	RSA-18A	93	GE ICCB Power Break Manual 2500-4000 A	RSA-91A M	142
GE ACB Type AK-1/2/3(A)-50/75/100	RSA-18B	93	GE ICCB Power Break Manual 2500-4000 A	RSA-91C M	143
GE ACB Type AKR 800-2000 A	RSK-AK14	235	GE ICCB Power Break Manual 800-2000 A	RSA-91 M	141
GE ACB Type AKR-4/5-A-30/50	RSA-45	107	GE ICCB Power Break Manual 800-2000 A	RSA-91B M	142
GE ACB Type AKR-4/5-A-30/50	RSA-45E	109	GE ICCB Power Break Manual/Electric 2500-4000 A	RSA-91A	141
GE ACB Type AKR-6, 10D-30/50 & AKR-4, 5-B-30/50	RSA-45A	108	GE ICCB Power Break Manual/Electric 800-2000 A	RSA-91	140
GE ACB Type AKR-6/10D-30/50 & AKR-4/5-B-30/50, Requires Bracket	RSK-AK11	234	GE LBS Medium-Voltage IC1074 Series	RSA-22	96
GE ACB Type AKR-6/10D-30/50-CT	RSA-45D	109	GE Magne-Blast Raise/Lower Toggle Switches	RSK-MBSW1	241
GE ACB Type AKR-6/10D-75/100	RSA-45B	108	GE MCC Limitamp Medium-Voltage Controller CR194 & CR7160/161 Series	RSA-9B	85
GE ACB Type AKR-6/10D-75/100	RSA-45C	108	GE MCC Limitamp Medium-Voltage Controller CR194 & CR7160/161 Series	RSA-9C	86
GE ACB Type AKR-6/10D-75/100	RSK-AK12	234	GE MCC Limitamp Medium-Voltage Controller CR194 & CR7160/161 Series	RSA-9E	86
GE ACB Type AKR-6/7/8/910D-30S	RSA-29A	98	GE MCC Limitamp Medium-Voltage Controller Manual	RSA-9R	86
GE ACB Type AL Manually Operated up to 1600 A	RSA-209	210	GE MCC Limitamp Medium-Voltage Controller Remote/ Electric Interlock Defeat	RSA-9R	87
GE ACB Type AMH 1200-2000 A	RSA-217	211	GE MCC Main Disconnect	RSA-46D	110
GE ACB Type M-PACT Low-Voltage	RSA-203	207	GE MCCB E Line 150 A Frame Size TE/TEB/TEC/TECL/ TED/TEML/THED	RSA-187A	200
GE ACB WavePro 3200-5000 A & EntelliGuard 3200-500 A	RSA-59C	123	GE MCCB F Line 225 A Frame Size THFK/TF/TFC/TFJ/ TFK/TFL	RSA-187B	200
GE ACB WavePro 3200-5000 A & EntelliGuard 3200-5000 A	RSA-59B	123	GE MCCB F Line 225 A Frame Size Type THFK/TF/TFC/ TFJ/TFK/TFL (Recessed Mounted)	RSA-187F	201
GE ACB WavePro 800-2000 A	RSA-59A	123	GE MCCB J Line 600 A Frame Size THJK/TJ/TJC/TJD/TJJ/ TJK/TJL	RSA-187C	201
GE ACB WavePro 800-2000 A & EntelliGuard 800-2000 A	RSA-59	122	GE MCCB J Line 600 A Frame Size THJK/TJ/TJC/TJD/TJJ/ TJK/TJL	RSA-187G	201
GE ACB WavePro 800-2000 A & EntelliGuard 800-2000 A	RSK-WAV21	246	GE MCCB K Line 1200 A Frame Size THKM/TKC/TKL/TKM	RSA-187H	202
GE AV Line Switchboard Rotary Operating Handle	RSA-188B	203	GE MCCB K Line 1200 A Frame Size, Flush Mounted, with Lockout-Tagout Device Installed	RSA-187	200
GE AV Line Switchboard Rotary Operating Handle for Individually Mounted Devices/Branch Fusible Switch or Branch Circuit Breaker	RSA-188C	203	GE MCCB Q-Line 2/3 Pole THQD/THQDL/TQD/TQDL	RSA-56C	117
GE Bolted Pressure Switch HPC Switch 2000 4000 A	RSA-73	131	GE MCCB Q-Line 3 Pole Gang THQB/THHQB/THQC/ THHQC/THQL/THHQL/THQP/TQ/TQB/TQC/TQL/TXQB/ TXQC/TXQL	RSA-56B	117
GE Bolted Pressure Switch HPC Switch 2000-4000 A	RSA-73C	132	GE MCCB Q-Line Single Pole THQB/THHQB/THQC/ THHQC/THQL/THHQL/THQP/TQ/TQB/TQC/TQL/TXQB/ TXQC/TXQL	RSA-56	116
GE Bolted Pressure Switch HPC Switch 800 1600 A	RSA-73A	131	GE MCCB THLC2 Series 175-400 A Frame Size Type THLC2 & THLC4 series	RSA-187I	202
GE Bolted Pressure Switch HPC Switch 800-1600 A	RSA-73B	132	GE MCCB Tri-Break (Fused) TB Frame Size TB4/TBC4	RSA-195A	204
GE Breaker Control Switch	RSA-1F	81	GE MCCB Type TEY MCCB 10-100 A, includes Pole	RSA-187J	202
GE Breaker Control Switch	RSA-1J	81	GE MCCB ZJ8 Link Operated Air Switch	RSA-196	204
GE Breaker Control Switch	RSA-1M	82	GE Panelboard Switch 300-Line Control Nonreversing Combination Magnetic Starter	RSA-62	124
GE E9000 Evolution MCC Bucket Size 1-4 Standard & Size 1 Horizontal	RSA-39	104	GE Panelboard Switch Type QMR/THFP 240/600 V 30/60/100 A Twin	RSA-127	165
GE E9000 Evolution MCC Main	RSA-39B	104			
GE Flange Handle Operator STDA1	RSA-183	197			
GE Flange Handle Operator STDA2	RSA-183A	198			
GE Handle Operator SE100CS/TE100CS Breaker Switch NEMA Type4, 4X Enclosure; TE/SE Series Breakers	RSA-243	216			
GE Handle Operator SG400CS Breaker Switch NEMA Type 4, 4X Enclosure; Spectra G Series Breakers	RSA-243A	216			
GE Handle Operator Type TDR Integral Handle Mechanism	RSA-8B	85			
GE Heavy Duty Safety Switch Type TC 800 & 1200 A; NEMA Type 1 & 3R; Models 7,8,9,10	RSA-168	191			

MANUFACTURER/EQUIPMENT	RSA/RSK NUMBER	PAGE	MANUFACTURER/EQUIPMENT	RSA/RSK NUMBER	PAGE
GE Panelboard Switch Type QMR/THFP 240/600 V 400/600 A	RSA-127B	165	ITE/Siemens Panelboard Switch Vacu-Break Fusible Panel Units V2BXXX, V7BXXXX	RSA-154G	180
GE Panelboard Switch Type QMR/THFP 240/600 V 800/1200 A	RSA-127C	166	ITI Control Switch Series 95	RSK-CS03W	236
GE SE-100 Series LBS 600-1200A 5kV/15kV	RSA-43	107	Klockner Moeller/Moeller Electric Door Coupling Handle Operator for PKZM 0/PKZM 01/PKZM 4 Breaker	RSA-210	210
GE Spectra Series MCCB SE Frame 15-100 A & SF Frame 70-250 A, Flush Mount	RSA-72C	130	Klockner Moeller/Moeller Electric IVS/Modan 2000/Modan 3000 MCC Handle Operator	RSA-140	173
GE Spectra Series MCCB SG Frame 125-600 A Flush Mount	RSA-72B	130	Klockner Moeller/Moeller Electric IVS/Modan 2000/Modan 3000 MCC Handle Operator	RSA-140B	174
GE Spectra Series MCCB SK Frame 300-1200 A, Flush Mount with Handle Extension	RSA-72A	130	Kraus & Naimer Selector Switch Size S1 With "F" Type Handle	RSA-200A	206
GE Spectra Series MCCB SK Frame 300-1200 A, Flush Mount without Handle Extension	RSA-72	129	Kraus & Naimer Selector Switch Size S1 With F221 Face Configuration for Label at Top, Handle Type "O" Model G412	RSA-200B	206
GE Spectra Series MCCB SK Frame 300-1200 A, Recessed Mount with Handle Extension	RSA-72D	131	L&T DN2 MCCB Rotary Handle Actuator	RSA-252	218
GE Spectra Type ADS Panelboard Disconnect Switch 30/60/100/200 A	RSA-160	182	L&T DSINE ROH DM Rotary Handle Actuator	RSA-252A	219
GE Spectra Type ADS Panelboard Disconnect Switch 400/600 A	RSA-160C	183	Merlin Gerin COMPACT MCCB CK Frame 400-1200 A	RSA-149C	175
GE Spectra Type ADS Panelboard Disconnect Switch 800/1200 A	RSA-160D	183	Merlin Gerin COMPACT MCCB CM Frame, 1250-2500 A	RSA-149D	175
GE TDM Door-Mounted Handle Operating Mechanism & 7098 MCC Bucket Size 1-4	RSA-34B	102	Merlin Gerin COMPACT NS MCCB	RSA-250	218
GE TDM Door-Mounted Handle Operating Mechanism/SKOM2 Operating Mechanism/7098 MCC Bucket Size 1-4	RSA-34	102	Merlin Gerin ICCB Type MP (All)	RSA-119	161
GE TH Series General Duty Safety Switch, 30 A, 240 VAC	RSA-169F	193	Merlin Gerin ICCB Type MP (All)	RSA-119A	162
GE THN Series Heavy Duty Safety Switch, Operates Catalog Number THN3321, 30 A/240 VAC/250 VDC	RSA-169	192	Merlin Gerin ICCB Type MP (All)	RSA-119B	162
GEC Alsthom Rotary Style Load Switch	RSA-293	228	Merlin Gerin SF6/YFS6 CB Close/Trip	RSA-61	124
Gould/ITE HS3B MCCB 2500 A and Above	RSA-276	223	Merlin Gerin/Square D ICCB Masterpact NT (All)	RSA-180	196
ITE ACB Type KA/KB/KC/KD/KE	RSA-79	134	Merlin Gerin/Square D Masterpact NT (All)	RSK-NT20	242
ITE ACB Type KA/KB/KC/KD/KE	RSA-79A	135	Merlin Gerin/Square D Masterpact NW (All)	RSK-NW20	242
ITE Type ET/ETI/ETO/ET-75/ET-C MCCB E Frame	RSA-66	126	Metron Handle Operator Electric Fire Pump Controller Series M200/M300/M400/M420/M430/M435/M450/M700	RSA-213A	211
ITE Type ET/ETI/ETO/ET-75/ET-C MCCB F Frame 2/3 Pole	RSA-66A	126	Mitsubishi Medium-Voltage MCC Handle	RSA-32	101
ITE Type ET/ETI/ETO/ET-75/ET-C MCCB J/HJKL Frame 2/3 Pole	RSA-66C	126	Mitsubishi WS-V Series Rotary Handle, 62mm Diameter, 30-250 A Frame Size	RSA-288	227
ITE Type ET/ETI/ETO/ET-75/ET-C MCCB KM/KP/HP/CP Frames 2/3 Pole	RSA-66G	127	Motortronics Medium-Voltage Soft Starter MVC Plus, Overall Handle Length 14.125"	RSA-244A	217
ITE/Gould/Bulldog/Siemens Vacu-Break Heavy Duty Safety Switch Type 1	RSA-197E	205	Motortronics Medium-Voltage Soft Starter MVC Plus, Overall Handle Length 7"	RSA-244	216
ITE/Gould/Siemens MCC Type 5600 Series	RSA-77	133	Nelson Electric Class 1035E LVMCC Rotary Handle Operator	RSA-281	224
ITE/Gould/Telemecanique 9600 Series MCC Bucket Size 1-4	RSA-86	138	Powell MCCB Series P-13000 Class E-2 Controller	RSA-67	127
ITE/Siemens Enclosure Handle Operator for MCCBs	RSA-53A	115	Powercon Load Break Interrupter Switch	RSA-31	100
ITE/Siemens MCCB Sentron Series Type ED/HED/CED	RSA-136A	170	Powercon Load Break Interrupter Switch	RSA-31A	101
ITE/Siemens MCCB Sentron Series Type FD/HFD/HHFD/CFD/FXD/HFXD/HHFXD/CFXD	RSA-136C	171	R & IE LIS	RSA-247	217
ITE/Siemens MCCB Sentron Series Type JD/HJD/HHJD/CJD/JXD/HJXD/HHJXD/CJXD/LD/HLD/HHLD/CLD/LXD/HLXD/HLLXD/CLXD	RSA-136	170	Rockwell Automation/Allen Bradley Bulletin 1494R Variable Depth Door Mounted Rotary Disconnect Switch 100-200 A	RSA-204A	208
ITE/Siemens MCCB Sentron Series Type LMD/HLMD/LMXD/HLMXD/MD/HMD/CMD/MXD/HMXD/CMXD, ND/HND/CND/NXD/HNXD/CNXD, PD/HPD/CPD/PXD/HPXD/CPXD/RD/HRD/RXD/HRXD	RSA-136B	171	Rockwell Automation/Allen Bradley Bulletin 1494R Variable Depth Door Mounted Rotary Disconnect Switch 30-60 A	RSA-204	208
ITE/Siemens MCCB Sentron Series Type LMD/MD/ND/PD/RD with Handle Extension	RSA-136E	172	Rockwell Automation/Allen-Bradley CENTERLINE 1500 Series 5 kV Starter	RSK-ABL3W	233
ITE/Siemens MCCB Sentron Series Type TD/HTD/HHTD/STD/SHTD/SHHTD	RSA-136D	171	S&C LIS with Protruding Handle Operator	RSA-116	158
ITE/Siemens Panelboard Switch High Contact Pressure Switch HCPXXXH	RSA-154A	178	S&C LIS with Recessed Handle Operator	RSA-116A	159
			S&C LIS with Non-Standard Enclosure	RSA-116C	159
			S&C LIS, Flush Mounted	RSA-116D	159
			S&C LIS Flush Application with 13.5" Handle Overall	RSA-116E	160
			S&C LIS Type MS Medium-Voltage	RSA-249	218
			S&C PMH-9/PME Pad Mounted Mini-Rupter Switch	RSA-267	220
			Schneider Electric/Square D ICCB Masterpact NT - All Sizes	RSA-180A	197

<b>MANUFACTURER/EQUIPMENT</b>	<b>RSA/RSK NUMBER</b>	<b>PAGE</b>	<b>MANUFACTURER/EQUIPMENT</b>	<b>RSA/RSK NUMBER</b>	<b>PAGE</b>
Schneider Electric/Square D ICCB Masterpact NW All	RSA-120A	163	Square D Class 9810 Series Type TS Three-Position Switch	RSA-275	222
Schneider Electric/Square D Vacuum Circuit Breaker Type VR 1200-3000 A	RSA-176A	195	Square D Disconnect Switch, Rotary	RSA-296	229
Schneider Electric MCC Motorpact Medium-Voltage Motor Starter	RSA-50	112	Square D Enclosed CB Type NEMA 12/3R/Series E3 100-600 A & 300-1000 A	RSA-201	207
Schneider Electric MCC Motorpact Medium-Voltage Motor Starter	RSA-50A	113	Square D Enclosed CB Type NEMA 3, 3R, 4, 4X, 5, 12 Housed in an M800SS (Stainless Steel) Enclosure	RSA-201B	207
Schneider Electric/Square D Blockset Rotary Handle Actuator	RSA-251	218	Square D Heavy-Duty Safety Switch 200 A H/HU-224/324/364/464-N/A/N/NRB/RB/A/AKW	RSA-166B	190
Siemens 3VA64 Series MCCB 450, 500, 600 A Frame Sizes	RSA-286	225	Square D Heavy-Duty Safety Switch 30/60 A H/HU-221/222/321/322/361-DS	RSA-166G	191
Siemens ACB Type WL 800-6000 A	RSK-WL01	246	Square D I-Line MCCB - P Frame 600-2500 A, Flush Mounted	RSK-P11W	242
Siemens ACB Type WL 800-6000 A with Siemens Racking Rails	RSK-WL01R	247	Square D ICCB Masterpact NW (All)	RSA-120	162
Siemens Handle Operator CRHOH Rotary Door Mounted	RSA-52A	115	Square D ICCB Masterpact NW (All)	RSA-120B	163
Siemens Handle Operator RHOH Rotary Door Mounted	RSA-52	114	Square D ICCB SE Series (All)	RSA-155	180
Siemens HF364NR, HF364R, RPV, RPVPG Safety Switch	RSA-205C	209	Square D ICCB SE Series (All)	RSK-SE06	245
Siemens ICCB Type SB/SBA/SBS	RSA-16	91	Square D ICCB SEF/SED - All Sizes	RSA-155A	181
Siemens ICCB Type SB/SBA/SBS	RSA-16A	91	Square D LBS Mini-Break/Mini-Flex	RSA-21	96
Siemens ICCB Type SB/SBA/SBS	RSA-16B	92	Square D LIS HVL/cc Medium-Voltage Metal-Enclosed Switchgear w/ Over Toggle Mechanism	RSA-27	97
Siemens ICCB Type SB/SBA/SBS	RSK-SBH2	244	Square D LIS HVL/cc Medium-Voltage Metal-Enclosed Switchgear w/ Stored Energy Mechanism	RSA-27A	97
Siemens ICCB Type WN/WL/3WN/3WL Low-Voltage ACB	RSA-158	182	Square D LIS HVL/cc Medium-Voltage Metal-Enclosed Switchgear w/ Stored Energy Mechanism	RSA-27B	98
Siemens ICCB WL - All Sizes	RSA-158A	182	Square D MCC Class 8198 High-Voltage Motor Starter	RSA-159	182
Siemens MCC 81000 Medium-Voltage Controller	RSA-14	90	Square D MCC Iso-Flex Model 4 Class 8198 Medium-Voltage Controller	RSA-44	107
Siemens MCC 81000 Medium-Voltage Controller	RSA-14A	90	Square D MCC Size 1-5 Bucket & Main	RSA-33	101
Siemens MCC 81000 Medium-Voltage Controller	RSA-14B	90	Square D MCCB E Frame	RSA-57	117
Siemens MCC SIMOVAC Medium-Voltage Controller	RSA-15	91	Square D MCCB F/K Frame	RSA-57B	118
Siemens MCCB Type BL, BLH, Single Pole 10-70 A	RSK-BL30W	235	Square D MCCB F/K Frame	RSA-57C	118
Siemens MCCB Type BL/BLH 2 Pole	RSA-55A	116	Square D MCCB L Frame	RSA-57G	119
Siemens MCCB Type BL/BLH Single Pole	RSA-55	116	Square D MCCB L Frame	RSA-57I	119
Siemens NRH425-1, F355 Safety Switch	RSA-205G	210	Square D MCCB L/Q4 Frame	RSA-57D	118
Siemens Oversized HF361RL, HNF361RL, HF222NR, HF322NR, HF262R, HF362R, HF362NR, HNF262NR, HNF362NR Safety Switch	RSA-205B	209	Square D MCCB L/Q4 Frame	RSA-57E	119
Siemens Panelboard Switch Vacu-Break Fusible Panel Units Main Switch VF357/VB357/VF358/VB358	RSA-154F	180	Square D MCCB M Frame	RSA-57J	120
Siemens Panelboard Switch Vacu-Break Fusible Panel Units V2EXXXX/V7EXXXX	RSA-154B	179	Square D MCCB M Frame	RSA-57K	120
Siemens Panelboard Switch Vacu-Break Fusible Panel Units V2FXXXX/V7FXXXX	RSA-154C	179	Square D MCCB M Frame	RSA-57N	120
Siemens Panelboard Switch Vacu-Break Fusible Panel Units V2HXXXX/V7HXXXX	RSA-154D	180	Square D MCCB M Frame	RSA-57O	121
Siemens/Siemens-Allis ACB Charge Assembly Type RL/RLE/RLF 3200-5000 A	RSA-51C	114	Square D MCCB N Frame	RSA-57P	121
Siemens/Siemens-Allis ACB Close/Trip Assembly Type RL/RLE/RLF 3200-5000 A	RSA-51C	114	Square D MCCB N Frame	RSA-57T	121
Siemens/Siemens-Allis ACB Type RL/RLE/RLF 3200-5000 A	RSA-51A	113	Square D MCCB N Frame	RSA-57U	122
Siemens/Siemens-Allis ACB Type RL/RLE/RLF 3200-5000 A	RSK-RLI2	243	Square D MCCB P Frame	RSA-57V	122
Siemens/Siemens-Allis ACB Type RL/RLE/RLF/RLI 800-2000 A	RSA-51	113	Square D MCCB PowerPact B Frame (includes BD, BG, BJ, BK) 15-125 A	RSA-164R	189
Siemens/Siemens-Allis Marq21 Model 90 MCC Bucket Size 1-4	RSA-37	104	Square D MCCB PowerPact E Frame 15-125 A	RSA-164B	186
Siemens/Siemens-Allis MarQ21, Model-90, Model-95 MCC Size 5	RSA-82A	136	Square D MCCB PowerPact H Frame 15-150 A	RSA-164C	186
Siemens/Siemens-Allis Marq21/Model 90/Model 95/Model 95+ MCC Bucket Size 1-4	RSA-82	136	Square D MCCB PowerPact J Frame 150-250 A	RSA-164E	187
Square D Bolted Pressure Switch Manually Operated Type Bolt-Loc BL Series & Type AV Switch AVO Series with AVFQ/AVSQ Handle Operator	RSA-181	197	Square D MCCB PowerPact L Frame 250-600 A	RSA-164H	187
			Square D MCCB PowerPact M Frame 300-800 A	RSA-164I	188
			Square D MCCB PowerPact P Frame 250-1200 A	RSA-164J	188
			Square D MCCB PowerPact Q Frame (includes QB, QD, QG, QJ) 70-250 A	RSA-164D	187
			Square D MCCB PowerPact R Frame 600-3000 A	RSA-164K	188
			Square D Model 3 MCC Size 1-4	RSA-85	138

MANUFACTURER/EQUIPMENT	RSA/RSK NUMBER	PAGE	MANUFACTURER/EQUIPMENT	RSA/RSK NUMBER	PAGE
Square D Model 4 MCC Bucket Size 1-4	RSA-97	145	Westinghouse ACB Type DB-15/25 15-600 A	RSA-80A	135
Square D Model 4 MCC Bucket Size 5	RSA-97A	146	Westinghouse ACB Type DB-50 200-1600 A	RSA-95	143
Square D Model 4 MCC Bucket Size 5	RSA-97B	146	Westinghouse ACB Type DB-50 200-1600 A	RSA-95A	143
Square D Model 5 MCC Bucket Size 1-5	RSA-185	199	Westinghouse ACB Type DHP 1200-3000 A	RSA-11	88
Square D Model 6 MCC legacy with 4.5" Handles, Model Year Pre-2006	RSK-SDL6W	245	Westinghouse ACB Type DHP 1200-3000 A, Close	RSA-11B	88
Square D Model 6 MCC Size 1-5 Bucket & Main	RSA-33A	102	Westinghouse DFS Air Switch, Close/Trip Assembly	RSA-64	125
Square D Model 6 MCC with 4.0" Handles, Model Year 2006 and Newer	RSK-SDL6C	244	Westinghouse LBS Type ADM Disconnect Switch	RSA-186	200
Square D Panelboard Switch Type QMBW-QMB2 21TW/222TW/223TW/321TW/322TW/323TW/2 61TW/262TW/ 263TW/361TW/362TW/363TW; QMJ361T/362T/363T/364T	RSA-123A	164	Westinghouse LBS Type WLI	RSA-117	160
Square D Panelboard Switch Type QMBW-QMB224W/324W/264W/364W, QMJ365	RSA-123	163	Westinghouse LBS Type WLI with Permanent Handle	RSA-117D	161
Square D Panelboard Switch Type QMBW-QMB225W/325 W/326W/365W/366W/367W/368W; QMJ366	RSA-123C	164	Westinghouse MCC Type W Size 1-4	RSA-7	83
Square D Power Zone LBS	RSA-147	174	Westinghouse MCC Type W Size 1-4	RSA-7A	84
Square D Power Zone LBS	RSA-147A	175	Westinghouse MCC Type W Size 5	RSA-7B	84
Square D PS4620 Busway Switch 400 A	RSA-266B	220	Westinghouse/Cutler-Hammer MCCB JA/KA/HKA Frame	RSA-20B	94
Square D Class 9421 Type L Circuit Breaker Mechanism	RSA-161A	184			
Square D S-2 Load Break Switch, Lever Style	RSA-297	229			
Square D Safety Switch Heavy Duty Safety Switch 200 A, H, HU-224, 324, 364, 464, 664-N/A, N, NRB, RB, A, AWK (Series F5 & F6)	RSA-166A	190			
Square D Safety Switch Heavy Duty Safety Switch 240 & 600 V; 400, 600, 800, & 1200 A (Series E4 & E5 Only)	RSA-166D	190			
Square D Safety Switch Heavy Duty Safety Switch 30 A, H, HU-221, 321, 361-N/A, N, NRB, RB, A, AWK (Series F5 & F6)	RSA-166	189			
Square D Safety Switch Heavy Duty Safety Switch 60 & 100 A, H, HU-222, 223, 322, 323, 363, 462, 463-N/A, N, NRB, RB (Series F5 & F6)	RSA-166E	191			
Square D Type QMB Safelex Panelboard Switch 12.0"/15.0"/18.0"; Single; 400/600 A Series 1 or 4	RSA-134B	167			
Square D Type QMB Safelex Panelboard Switch 2000 A	RSA-134H	167			
Square D Type QMB Safelex Panelboard Switch 6.0"; Twin; 30/60 A; Series 2 or 4 & 7.5"; Twin; 60/100 A, Series 2 or 4	RSA-134	166			
Square D/GTE/Sylvania Bolted Pressure Switch Bolt-Loc BL Series 1600-4000 A Frame	RSA-100C	147			
Square D/GTE/Sylvania Bolted Pressure Switch Bolt-Loc BP Series 2500-4000 A Frame	RSA-100A	147			
Square D/GTE/Sylvania Bolted Pressure Switch Bolt-Loc Type BP Series 800-2000 A	RSA-100B	147			
Terasaki MCCB S400-PE	RSA-124	164			
Terasaki/Hyundai ACB TemPower Type 630-4000 A & HAT 630-5000 A	RSA-233	215			
Terasaki/Hyundai ACB TemPower Type AT Low Voltage 630-4000 A & HAT Low-Voltage 630-5000 A	RSA-233A	215			
TG Series General Duty Safety Switch 200 A, 240 VAC	RSA-169D	193			
TornaTech GP Series Fire Pump Controller	RSA-280	224			
Toshiba JK Series MCC Starter/Controller	RSA-54	115			
UK Switch Breaker Control Switch	RSA-ID	80			
Unelec CNX LVACB With Charging Handle	RSA-289	227			
Various, Miscellaneous Single Push Buttons	RSK-PB16	243			
Westinghouse ACB Type 50DH-150/250/350	RSA-23	97			
Westinghouse ACB Type DA-50	RSA-104	149			
Westinghouse ACB Type DB-15/25 15-600 A	RSA-80	135			

# Product Index

<b>RSA/RSK NUMBER</b>	<b>MANUFACTURER/EQUIPMENT</b>	<b>PAGE</b>	<b>RSA/RSK NUMBER</b>	<b>MANUFACTURER/EQUIPMENT</b>	<b>PAGE</b>
RSA-1	Electroswitch/GE/Westinghouse/ITI/Shalco Breaker Control Switch	79	RSA-16	Siemens ICCB Type SB/SBA/SBS	91
RSA-1A	Electroswitch Breaker Control Switch	79	RSA-16A	Siemens ICCB Type SB/SBA/SBS	91
RSA-1B	Electroswitch/Westinghouse Breaker Control Switch	79	RSA-16B	Siemens ICCB Type SB/SBA/SBS	92
RSA-1C	Electroswitch Breaker Control Switch	80	RSA-17	Allis-Chalmers/Siemens/Siemens-Allis ACB Type FA/FB/FC	92
RSA-1D	UK Switch Breaker Control Switch	80	RSA-18	GE ACB Type AK-1/2/3(A)-50/75/100	92
RSA-1E	Electroswitch/GE/Westinghouse/ITI/Shalco Breaker Control Switch	80	RSA-18A	GE ACB Type AK-1/2/3(A)-50/75/100	93
RSA-1F	GE Breaker Control Switch	81	RSA-18B	GE ACB Type AK-1/2/3(A)-50/75/100	93
RSA-1H	Cutler-Hammer Breaker Control Switch	81	RSA-20	Cutler-Hammer/Westinghouse MCCB E/F Frame 10-150 A	93
RSA-1J	GE Breaker Control Switch	81	RSA-20A	Cutler-Hammer/Westinghouse MCCB JB/KB/HKB Frame	94
RSA-1M	GE Breaker Control Switch	82	RSA-20B	Westinghouse/Cutler-Hammer MCCB JA/KA/HKA Frame	94
RSA-2	All Manufacturers, Push Button	82	RSA-20C	Cutler-Hammer/Westinghouse MCCB LA/LAB/HLA/LC Frame	94
RSA-2B	All Manufacturers, Push Button	82	RSA-20CR	Cutler-Hammer/Westinghouse MCCB L Frame 125-600 A	95
RSA-2D	All Manufacturers, Push Button	83	RSA-20D	Cutler-Hammer/Westinghouse MCCB MA/HMA Frame MC	95
RSA-2HD	All Manufacturers, Push Button	83	RSA-20E	Cutler-Hammer/Westinghouse MCCB NB/HNB Frame NC	95
RSA-7	Westinghouse MCC Type W Size 1-4	83	RSA-20F	Cutler-Hammer/Westinghouse MCCB PB Frame PA/PC	96
RSA-7A	Westinghouse MCC Type W Size 1-4	84	RSA-21	Square D LBS Mini-Break/Mini-Flex	96
RSA-7B	Westinghouse MCC Type W Size 5	84	RSA-22	GE LBS Medium-Voltage IC1074 Series	96
RSA-8	GE 7700 MCC Size 1-4 Bucket Handle Operator & Type TDR Integral Handle Mechanism	84	RSA-23	Westinghouse ACB Type 50DH-150/250/350	97
RSA-8A	GE 7700 MCC Size 5 Bucket Handle Operator & Type TDR Integral Handle Mechanism	85	RSA-27	Square D LIS HVL/cc Medium-Voltage Metal-Enclosed Switchgear w/ Over Toggle Mechanism	97
RSA-8B	GE Handle Operator Type TDR Integral Handle Mechanism	85	RSA-27A	Square D LIS HVL/cc Medium-Voltage Metal-Enclosed Switchgear w/ Stored Energy Mechanism	97
RSA-9B	GE MCC Limitamp Medium-Voltage Controller CR194 & CR7160/161 Series	85	RSA-27B	Square D LIS HVL/cc Medium-Voltage Metal-Enclosed Switchgear w/ Stored Energy Mechanism	98
RSA-9C	GE MCC Limitamp Medium-Voltage Controller CR194 & CR7160/161 Series	86	RSA-29	GE ACB Type AK-1/2/3-25	98
RSA-9E	GE MCC Limitamp Medium-Voltage Controller CR194 & CR7160/161 Series	86	RSA-29A	GE ACB Type AKR-6/7/8/910D-30S	98
RSA-9R	GE MCC Limitamp Medium-Voltage Controller Manual Interlock Defeat	86	RSA-29B	GE ACB Type AK-1/2/3-25 Close/Trip	99
RSA-9R	GE MCC Limitamp Medium-Voltage Controller Remote/Electric Interlock Defeat	87	RSA-30	ABB/BBC/ITE ACB K-Line	99
RSA-10	Cutler-Hammer/Westinghouse MCC Ampguard Legacy Style Handle Operator	87	RSA-30A	ABB/BBC/ITE ACB K-Line	99
RSA-10A	Cutler-Hammer/Eaton MCC Ampguard Current Style Handle Operator	87	RSA-30B	ABB/BBC/ITE ACB K-Line/K Don	100
RSA-10F	Eaton/Cutler-Hammer MCC Ampgard	88	RSA-30C	ABB/BBC/ITE ACB K-Line/K Don	100
RSA-11	Westinghouse ACB Type DHP 1200-3000 A	88	RSA-31	Powercon Load Break Interrupter Switch	100
RSA-11B	Westinghouse ACB Type DHP 1200-3000 A, Close	88	RSA-31A	Powercon Load Break Interrupter Switch	101
RSA-12A	Cutler-Hammer/Square D/Westinghouse ACB Type DS (All)	89	RSA-32	Mitsubishi Medium-Voltage MCC Handle	101
RSA-12B	Cutler-Hammer/Square D/Westinghouse ACB Type DS (All)	89	RSA-33	Square D MCC Size 1-5 Bucket & Main	101
RSA-12C	Cutler-Hammer/Square D/Westinghouse ACB Type DS (All)	89	RSA-33A	Square D Model 6 MCC Size 1-5 Bucket & Main	102
RSA-14	Siemens MCC 81000 Medium-Voltage Controller	90	RSA-34	GE TDM Door-Mounted Handle Operating Mechanism/SKOM2 Operating Mechanism/7098 MCC Bucket Size 1-4	102
RSA-14A	Siemens MCC 81000 Medium-Voltage Controller	90	RSA-34B	GE TDM Door-Mounted Handle Operating Mechanism & 7098 MCC Bucket Size 1-4	102
RSA-14B	Siemens MCC 81000 Medium-Voltage Controller	90	RSA-35	Cutler-Hammer/Westinghouse/Eaton 11-300 MCC Bucket & MCCB Slide Plate Type Handle Mechanism	103
RSA-15	Siemens MCC SIMOVAC Medium-Voltage Controller	91	RSA-35B	Cutler-Hammer/Westinghouse/Eaton 11-300 MCC Bucket & MCCB Slide Plate Type Handle Mechanism	103
			RSA-36A	Cutler-Hammer Freedom Unitrol	103
			RSA-37	Siemens/Siemens-Allis Marq21 Model 90 MCC Bucket Size 1-4	104

<b>RSA/RSK NUMBER</b>	<b>MANUFACTURER/EQUIPMENT</b>	<b>PAGE</b>	<b>RSA/RSK NUMBER</b>	<b>MANUFACTURER/EQUIPMENT</b>	<b>PAGE</b>
RSA-39	GE E9000 Evolution MCC Bucket Size 1-4 Standard & Size 1 Horizontal	104	RSA-57	Square D MCCB E Frame	117
RSA-39B	GE E9000 Evolution MCC Main	104	RSA-57B	Square D MCCB F/K Frame	118
RSA-40	Cutler-Hammer/Eaton Handle Operator Vari-Depth Type Mech; NEMA Type 1, 3R, 12	105	RSA-57C	Square D MCCB F/K Frame	118
RSA-41	Allen-Bradley CENTERLINE 2100 MCC Bucket Size 1-4	105	RSA-57D	Square D MCCB L/Q4 Frame	118
RSA-41A	Allen-Bradley CENTERLINE 2100 MCC Bucket Size 5	105	RSA-57E	Square D MCCB L/Q4 Frame	119
RSA-41B	Allen-Bradley CENTERLINE 2100 MCC Main	106	RSA-57G	Square D MCCB L Frame	119
RSA-41C	Allen-Bradley CENTERLINE 2100 MCC Horizontal Bucket Size 1	106	RSA-57I	Square D MCCB L Frame	119
RSA-42	Cutler-Hammer/Eaton Handle Operator Series C Rotary Through-the-Door Handle Mechanism	106	RSA-57J	Square D MCCB M Frame	120
RSA-43	GE SE-100 Series LBS 600-1200A 5kV/15kV	107	RSA-57K	Square D MCCB M Frame	120
RSA-44	Square D MCC Iso-Flex Model 4 Class 8198 Medium-Voltage Controller	107	RSA-57N	Square D MCCB M Frame	120
RSA-45	GE ACB Type AKR-4/5-A-30/50	107	RSA-57O	Square D MCCB M Frame	121
RSA-45A	GE ACB Type AKR-6, 10D-30/50 & AKR-4, 5-B-30/50	108	RSA-57P	Square D MCCB N Frame	121
RSA-45B	GE ACB Type AKR-6/10D-75/100	108	RSA-57T	Square D MCCB N Frame	121
RSA-45C	GE ACB Type AKR-6/10D-75/100	108	RSA-57U	Square D MCCB N Frame	122
RSA-45D	GE ACB Type AKR-6/10D-30/50-CT	109	RSA-57V	Square D MCCB P Frame	122
RSA-45E	GE ACB Type AKR-4/5-A-30/50	109	RSA-59	GE ACB WavePro 800-2000 A & EntelliGuard 800-2000 A	122
RSA-46	GE 8000 MCC Size 1-4	109	RSA-59A	GE ACB WavePro 800-2000 A	123
RSA-46A	GE 8000 MCC Size 1-4	110	RSA-59B	GE ACB WavePro 3200-5000 A & EntelliGuard 3200-5000 A	123
RSA-46B	GE 8000 MCC Size 5 Bucket/Style Main Disconnect	110	RSA-59C	GE ACB WavePro 3200-5000 A & EntelliGuard 3200-5000 A	123
RSA-46D	GE MCC Main Disconnect	110	RSA-61	Merlin Gerin SF6/YFS6 CB Close/Trip	124
RSA-47	Allen-Bradley CENTERLINE 2100 MCC Size 1-4 Bucket	111	RSA-62	GE Panelboard Switch 300-Line Control Nonreversing Combination Magnetic Starter	124
RSA-47A	Allen-Bradley CENTERLINE 2100 MCC Size 5 Bucket & 5 kV Starter	111	RSA-63	Driescher and Wittjohann Driwisa LBS	124
RSA-47B	Allen-Bradley CENTERLINE 2100 MCC Size 1-4 Bucket	111	RSA-64	Westinghouse DFS Air Switch, Close/Trip Assembly	125
RSA-48	Cutler-Hammer/Eaton ICCB Type Magnum DS/SB	112	RSA-65	ABB/BBC/ITE VersaRupter LIS/HK-HPL-C Drawout Interrupter Switch	125
RSA-48C	Eaton/Cutler-Hammer ICCB Type Magnum DS/SB	112	RSA-65A	ABB/BBC/ITE Type HK-HPL-C Drawout Interrupter Switch	125
RSA-50	Schneider Electric MCC Motorpact Medium-Voltage Motor Starter	112	RSA-66	ITE Type ET/ETI/ETO/ET-75/ET-C MCCB E Frame	126
RSA-50A	Schneider Electric MCC Motorpact Medium-Voltage Motor Starter	113	RSA-66A	ITE Type ET/ETI/ETO/ET-75/ET-C MCCB F Frame 2/3 Pole	126
RSA-51	Siemens/Siemens-Allis ACB Type RL/RLE/RLF/RLI 800-2000 A	113	RSA-66C	ITE Type ET/ETI/ETO/ET-75/ET-C MCCB J/HJKL Frame 2/3 Pole	126
RSA-51A	Siemens/Siemens-Allis ACB Type RL/RLE/RLF 3200-5000 A	113	RSA-66G	ITE Type ET/ETI/ETO/ET-75/ET-C MCCB KM/KP/HP/CP Frames 2/3 Pole	127
RSA-51C	Siemens/Siemens-Allis ACB Charge Assembly Type RL/RLE/RLF 3200-5000 A	114	RSA-67	Powell MCCB Series P-13000 Class E-2 Controller	127
RSA-51C	Siemens/Siemens-Allis ACB Close/Trip Assembly Type RL/RLE/RLF 3200-5000 A	114	RSA-69A	ABB/SACE ICCB Megamax F Low-Voltage Power Circuit Breaker 1200-6000 A, All Sizes	127
RSA-52	Siemens Handle Operator RHOH Rotary Door Mounted	114	RSA-69C	ABB/SACE ICCB Megamax F F3-F6 C/C/T	128
RSA-52A	Siemens Handle Operator CRHOH Rotary Door Mounted	115	RSA-69D	ABB/SACE ICCB Megamax F F3-F6 C/T	128
RSA-53A	ITE/Siemens Enclosure Handle Operator for MCCBs	115	RSA-71	Allen-Bradley CENTERLINE 2100 MCC 5kV Starter (1st generation, gray metal handle operator)	128
RSA-54	Toshiba JK Series MCC Starter/Controller	115	RSA-71B	Allen-Bradley CENTERLINE 2100 MCC 5kV Starter (2nd generation, flush mount, red/black plastic handle operator)	129
RSA-55	Siemens MCCB Type BL/BLH Single Pole	116	RSA-71C	Allen-Bradley CENTERLINE 2100 Handle Operator 5kV Starter (2nd generation, recessed mount, red/black plastic handle operator)	129
RSA-55A	Siemens MCCB Type BL/BLH 2 Pole	116	RSA-72	GE Spectra Series MCCB SK Frame 300-1200 A, Flush Mount without Handle Extension	129
RSA-56	GE MCCB Q-Line Single Pole THQB/THHQB/THQC/THHQC/THQL/THHQL/THQP/TQ/TQB/TQC/TQL/TXQB/TXQC/TXQL	116	RSA-72A	GE Spectra Series MCCB SK Frame 300-1200 A, Flush Mount with Handle Extension	130
RSA-56B	GE MCCB Q-Line 3 Pole Gang THQB/THHQB/THQC/THHQC/THQL/THHQL/THQP/TQ/TQB/TQC/TQL/TXQB/TXQC/TXQL	117			
RSA-56C	GE MCCB Q-Line 2/3 Pole THQD/THQDL/TQD/TQDL	117			

<b>RSA/RSK NUMBER</b>	<b>MANUFACTURER/EQUIPMENT</b>	<b>PAGE</b>	<b>RSA/RSK NUMBER</b>	<b>MANUFACTURER/EQUIPMENT</b>	<b>PAGE</b>
RSA-72B	GE Spectra Series MCCB SG Frame 125-600 A Flush Mount	130	RSA-96	ABB/SACE ICCB Emax Low-Voltage Power CB 800-6000 A, All Sizes & Tmax MCCBs 1600-3000 A	144
RSA-72C	GE Spectra Series MCCB SE Frame 15-100 A & SF Frame 70-250 A, Flush Mount	130	RSA-96A	ABB/SACE ICCB Emax E1, E2, E3, E4, E5, E6	144
RSA-72D	GE Spectra Series MCCB SK Frame 300-1200 A, Recessed Mount with Handle Extension	131	RSA-96C	ABB/SACE ICCB Emax2, 1.2	144
RSA-73	GE Bolted Pressure Switch HPC Switch 2000 4000 A	131	RSA-96D	ABB/SACE ICCB Emax2, 2.2, 4.2, 6.2	145
RSA-73A	GE Bolted Pressure Switch HPC Switch 800 1600 A	131	RSA-96E	ABB/SACE ICCB Emax2, 2.2, 4.2, 6.3	145
RSA-73B	GE Bolted Pressure Switch HPC Switch 800-1600 A	132	RSA-97	Square D Model 4 MCC Bucket Size 1-4	145
RSA-73C	GE Bolted Pressure Switch HPC Switch 2000-4000 A	132	RSA-97A	Square D Model 4 MCC Bucket Size 5	146
RSA-76	GE ICCB Power Break II, All Frame Sizes	132	RSA-97B	Square D Model 4 MCC Bucket Size 5	146
RSA-76C	GE ICCB Power Break II, All Frame Sizes	133	RSA-99	Clark/Sylvania 6200 MCC Bucket	146
RSA-76E	GE ICCB Power Break II, All Frame Sizes	133	RSA-100A	Square D/GTE/Sylvania Bolted Pressure Switch Bolt-Loc BP Series 2500-4000 A Frame	147
RSA-77	ITE/Gould/Siemens MCC Type 5600 Series	133	RSA-100B	Square D/GTE/Sylvania Bolted Pressure Switch Bolt-Loc Type BP Series 800-2000 A	147
RSA-78	Cutler-Hammer/Westinghouse MCC Cutler-Hammer F2100, Advantage, Series 2100; Westinghouse 5 Star Size 1-5 MCC Bucket	134	RSA-100C	Square D/GTE/Sylvania Bolted Pressure Switch Bolt-Loc BL Series 1600-4000 A Frame	147
RSA-78A	Cutler-Hammer/Westinghouse Type F2100/Advantage/ Series 2100/5 Star MCC Main	134	RSA-102	FPE Panelboard Switch Switchmatic Disconnect Switch QMQB Series 400 A	148
RSA-79	ITE ACB Type KA/KB/KC/KD/KE	134	RSA-102C	FPE Panelboard Switch Heavy Duty Safety Switch 100 A/600 V	148
RSA-79A	ITE ACB Type KA/KB/KC/KD/KE	135	RSA-102D	FPE Panelboard Switch Heavy Duty Safety Switch 600 A/600 V	148
RSA-80	Westinghouse ACB Type DB-15/25 15-600 A	135	RSA-103	Clark/Sylvania/Zinsco/FPE QSF Series Panelboard Switch 100-600 A	149
RSA-80A	Westinghouse ACB Type DB-15/25 15-600 A	135	RSA-103A	Clark/Sylvania/Zinsco/FPE QSF Series & 5310/5320/5325 MCC Bucket	149
RSA-82	Siemens/Siemens-Allis Marq21/Model 90/Model 95/ Model 95+ MCC Bucket Size 1-4	136	RSA-104	Westinghouse ACB Type DA-50	149
RSA-82A	Siemens/Siemens-Allis MarQ21, Model-90, Model-95 MCC Size 5	136	RSA-105	Allis-Chalmers/Siemens/Siemens-Allis ACB Type LA/LAF 1600-2000 A	150
RSA-83	Furnas/Siemens-Furnas/Siemens System 89 MCC Size 1-4 & TIASTAR	136	RSA-105A	Allis-Chalmers/Siemens/Siemens-Allis ACB Charge Assembly Type LA/LAF 3000-4000 A	150
RSA-83A	Furnas/Siemens-Furnas/Siemens System 89 MCC TiaStar Size 1-4	137	RSA-105A	Allis-Chalmers/Siemens/Siemens-Allis ACB Close/Trip Assembly Type LA/LAF 3000-4000 A	150
RSA-83C	Furnas/Siemens-Furnas/Siemens System 89 MCC	137	RSA-105B	Allis-Chalmers/Siemens/Siemens-Allis ACB Type LA/LAF 600-800 A	151
RSA-83D	Furnas/Siemens-Furnas/Siemens System 89 MCC	137	RSA-105C	Allis-Chalmers/Siemens/Siemens-Allis ACB Type LA/LAF 3000-4000 A	151
RSA-85	Square D Model 3 MCC Size 1-4	138	RSA-105D	Allis-Chalmers/Siemens-Allis/Siemens ACB LA/LAF 3000 A	151
RSA-86	ITE/Gould/Telemecanique 9600 Series MCC Bucket Size 1-4	138	RSA-105E	Allis-Chalmers/Siemens-Allis/Siemens ACB LA/LAF 1600-2000 A	152
RSA-87	Cutler-Hammer F10 Unitrol/9800 Unitrol MCC Size 1-4 Bucket Slider Style Operating Handle Mechanism	138	RSA-105F	Allis-Chalmers/Siemens/Siemens-Allis ACB Type LA/LAF 600-800 A	152
RSA-87A	Cutler-Hammer F10 Unitrol/9800 Unitrol MCC Size 5 Bucket Slider Style Operating Handle Mechanism	139	RSA-107	Elliot MCC Type 230	152
RSA-89	Cutler-Hammer 9800 Unitrol Size 1-4 MCC Bucket	139	RSA-108	Elliot Control Type 211 MVMCC	153
RSA-89A	Cutler-Hammer 9800 Unitrol Size 5 MCC Bucket	139	RSA-111E	ABB MCCB N Frame 1200 A Frame Size	153
RSA-90	GE ACB Type AK-1-25	140	RSA-111F	ABB MCCB P Frame 1600/2000/2500 A Frame Size	153
RSA-91	GE ICCB Power Break Manual/Electric 800-2000 A	140	RSA-112	FPE ACB Type H-2/HL-2 & H-3/HL-3 Manual	154
RSA-91 E	GE ICCB Power Break Electric 800-2000 A	140	RSA-112B	FPE ACB Type H-2/HL-2 & H-3/HL-3 Electric	154
RSA-91 M	GE ICCB Power Break Manual 800-2000 A	141	RSA-113	Cutler-Hammer/Westinghouse Series C MCCB N Frame 400-1200 A, White, Flush Mounted with Handle Extension	154
RSA-91A	GE ICCB Power Break Manual/Electric 2500-4000 A	141	RSA-113A	Cutler-Hammer/Westinghouse Series C MCCB K Frame 70-400 A, White, Flush Mounted	155
RSA-91A E	GE ICCB Power Break Electric 2500-4000 A	141	RSA-113B	Cutler-Hammer/Westinghouse Series C MCCB F Frame 10-225 A, White, Flush Mounted	155
RSA-91A M	GE ICCB Power Break Manual 2500-4000 A	142	RSA-113D	Cutler-Hammer/Westinghouse Series C MCCB J Frame 70-250 A, White, Flush Mounted	155
RSA-91B M	GE ICCB Power Break Manual 800-2000 A	142			
RSA-91C E	GE ICCB Power Break Electric 2500-4000 A	142			
RSA-91C M	GE ICCB Power Break Manual 2500-4000 A	143			
RSA-95	Westinghouse ACB Type DB-50 200-1600 A	143			
RSA-95A	Westinghouse ACB Type DB-50 200-1600 A	143			

<b>RSA/RSK NUMBER</b>	<b>MANUFACTURER/EQUIPMENT</b>	<b>PAGE</b>	<b>RSA/RSK NUMBER</b>	<b>MANUFACTURER/EQUIPMENT</b>	<b>PAGE</b>
RSA-113E	Cutler-Hammer/Westinghouse Series C MCCB M Frame 300-800 A, White, Flush Mounted	156	RSA-135A	Cutler-Hammer/Eaton/Pringle Bolted Pressure Switch QA-CBC Above 2500 A; Current Vintage; Straight Handle Only, with Shunt Trip, 90° of Handle Travel, 44" Min. Cubicle Width	168
RSA-113G	Cutler-Hammer/Westinghouse Series C MCCB R Frame 800-2500 A, White, Flush Mounted with Handle Extension	156	RSA-135D	Cutler-Hammer/Eaton/Pringle Bolted Pressure Switch QA 800 A Only; Current Vintage; Straight Handle Only, without Shunt Trip, 90° of Handle Travel, 24" Min. Cubicle Width	168
RSA-113I	Cutler-Hammer/Westinghouse Series C MCCB L Frame 125-600 A, White, Recessed Mounted without Handle Extension	156	RSA-135E	Cutler-Hammer/Eaton/Pringle Bolted Pressure Switch QA 1200-2500 A; Current Vintage; Straight Handle Only, without Shunt Trip, 115° of Handle Travel, 28"-32" Min. Cubicle Width	168
RSA-113J	Cutler-Hammer/Westinghouse Series C MCCB R Frame 800-2500 A, White, Stand-Alone Mounted with Handle Extension	157	RSA-135F	Cutler-Hammer/Eaton/Pringle Bolted Pressure Switch QA Above 2500 A; Current Vintage; Straight Handle Only, without Shunt Trip, 115° of Handle Travel, 44" Min. Cubicle Width	169
RSA-114	ABB/BBC/ITE ACB Type LK	157	RSA-135G	Cutler-Hammer/Eaton/Pringle Bolted Pressure Switch QA 800 A Only; Legacy Vintage; Straight Cast Aluminum Only, without Shunt Trip, 90° of Handle Travel, 24" Min. Cubicle Width	169
RSA-114A	ABB/BBC/ITE ACB Type LK	157	RSA-135H	Cutler-Hammer/Eaton/Pringle Bolted Pressure Switch QA 1200-2500 A; Legacy Vintage; Straight Cast Aluminum Only, without Shunt Trip, 115° of Handle Travel, 28"-32" Min. Cubicle Width	169
RSA-115	ABB/BBC/ITE ACB Type MB	158	RSA-135I	Cutler-Hammer/Eaton/Pringle Bolted Pressure Switch QA Above 2500 A; Legacy Vintage; Straight Cast Aluminum Only, without Shunt Trip, 115° of Handle Travel, 44" Min. Cubicle Width	170
RSA-115A	ABB/BBC/ITE ACB Type MB	158	RSA-136	ITE/Siemens MCCB Sentron Series Type JD/HJD/HHJD/CJD/JXD/HJXD/HHJXD/CJXD/LD/HLD/HHLD/CLD/LXD/HLXD/HHLXD/CLXD	170
RSA-116	S&C LIS with Protruding Handle Operator	158	RSA-136A	ITE/Siemens MCCB Sentron Series Type ED/HED/CED	170
RSA-116A	S&C LIS with Recessed Handle Operator	159	RSA-136B	ITE/Siemens MCCB Sentron Series Type LMD/HLMD/LMXD/HLMXD/MD/HMD/CMD/MXD/HMXD/CMXD, ND/HND/CND/NXD/HNXD/CNXD, PD/HPD/CPD/PXD/HPXD/CPXD/RD/HRD/RXD/HRXD	171
RSA-116C	S&C LIS with Non-Standard Enclosure	159	RSA-136C	ITE/Siemens MCCB Sentron Series Type FD/HFD/HHFD/CFD/FXD/HFXD/HHFXD/CFXD	171
RSA-116D	S&C LIS, Flush Mounted	159	RSA-136D	ITE/Siemens MCCB Sentron Series Type TD/HTD/HHTD/STD/SHTD/SHHTD	171
RSA-116E	S&C LIS Flush Application with 13.5" Handle Overall	160	RSA-136E	ITE/Siemens MCCB Sentron Series Type LMD/MD/ND/PD/RD with Handle Extension	172
RSA-117	Westinghouse LBS Type WLI	160	RSA-138	Allis-Chalmers/Siemens-Allis LIS Type SE	172
RSA-117A	Cutler-Hammer LBS Type MVS	160	RSA-138A	Allis-Chalmers/Siemens-Allis LIS Type SE2/SG 3328 or QB 5/15 kV Metal Enclosed Switch	172
RSA-117B	Eaton Type LBS	161	RSA-138B	Allis-Chalmers/Siemens-Allis LIS Type SE4 or QB 5/15 kV Metal Enclosed Switch	173
RSA-117D	Westinghouse LBS Type WLI with Permanent Handle	161	RSA-139	Allis-Chalmers/Siemens-Allis LIS Spacemaker/Spacemaker II Type 456 Contactor	173
RSA-119	Merlin Gerin ICCB Type MP (All)	161	RSA-140	Klockner Moeller/Moeller Electric IVS/Modan 2000/Modan 3000 MCC Handle Operator	173
RSA-119A	Merlin Gerin ICCB Type MP (All)	162	RSA-140B	Klockner Moeller/Moeller Electric IVS/Modan 2000/Modan 3000 MCC Handle Operator	174
RSA-119B	Merlin Gerin ICCB Type MP (All)	162	RSA-145E	ABB/SACE Isomax MCCB Size S7 1200 A Frame	174
RSA-120	Square D ICCB Masterpact NW (All)	162	RSA-147	Square D Power Zone LBS	174
RSA-120A	Schneider Electric/Square D ICCB Masterpact NW All	163	RSA-147A	Square D Power Zone LBS	175
RSA-120B	Square D ICCB Masterpact NW (All)	163	RSA-149C	Merlin Gerin COMPACT MCCB CK Frame 400-1200 A	175
RSA-123	Square D Panelboard Switch Type QMBW-QMB224W/324W/264W/364W, QMJ365	163	RSA-149D	Merlin Gerin COMPACT MCCB CM Frame, 1250-2500 A	175
RSA-123A	Square D Panelboard Switch Type QMBW-QMB2 21TW/222TW/223TW/321TW/322TW/323TW/2 61TW/262TW/ 263TW/361TW/362TW/363TW; QMJ361T/362T/363T/364T	164	RSA-150	ABB/BBC/ITE MCC 7850 Series Medium-Voltage Motor Starter	176
RSA-123C	Square D Panelboard Switch Type QMBW-QMB225W/325W/326W/365W/366W/367W/368W; QMJ366	164	RSA-151A	FPE ACB Type H/HF-1(All) Nonmagnetic Switchgear	176
RSA-124	Terasaki MCCB S400-PE	164			
RSA-126	FPE ACB Type DST-II	165			
RSA-127	GE Panelboard Switch Type QMR/THFP 240/600 V 30/60/100 A Twin	165			
RSA-127B	GE Panelboard Switch Type QMR/THFP 240/600 V 400/600 A	165			
RSA-127C	GE Panelboard Switch Type QMR/THFP 240/600 V 800/1200 A	166			
RSA-132A	FPE Autojet LIS 5-38 kV	166			
RSA-134	Square D Type QMB Safelex Panelboard Switch 6.0"; Twin; 30/60 A; Series 2 or 4 & 7.5"; Twin; 60/100 A, Series 2 or 4	166			
RSA-134B	Square D Type QMB Safelex Panelboard Switch 12.0"/15.0"/18.0"; Single; 400/600 A Series 1 or 4	167			
RSA-134H	Square D Type QMB Safelex Panelboard Switch 2000 A	167			
RSA-135	Cutler-Hammer/Eaton/Pringle Bolted Pressure Switch QA-CBC 2500 A & Below; Current Vintage; Straight Handle Only, with Shunt Trip, 90° of Handle Travel, 28"-32" Min. Cubicle Width	167			

<b>RSA/RSK NUMBER</b>	<b>MANUFACTURER/EQUIPMENT</b>	<b>PAGE</b>	<b>RSA/RSK NUMBER</b>	<b>MANUFACTURER/EQUIPMENT</b>	<b>PAGE</b>
RSA-151B	FPE ACB H/HF-1 (All Sizes)	176	RSA-164D	Square D MCCB PowerPact Q Frame (includes QB, QD, QG, QJ) 70-250 A	187
RSA-152	Cutler-Hammer Bolted Pressure Switch Boltswitch VL3612-ST	177	RSA-164E	Square D MCCB PowerPact J Frame 150-250 A	187
RSA-152C	Cutler-Hammer Bolted Pressure Switch Boltswitch SLB Series 600 V Pressure Contact Switch	177	RSA-164H	Square D MCCB PowerPact L Frame 250-600 A	188
RSA-152G	Cutler-Hammer Bolted Pressure Switch Boltswitch Series T 400-1200 A	177	RSA-164I	Square D MCCB PowerPact M Frame 300-800 A	188
RSA-153A	Cutler-Hammer/Westinghouse Type FDP & M50 Fusible Panelboard Switch 30/60/100 A Twin	178	RSA-164J	Square D MCCB PowerPact P Frame 250-1200 A	188
RSA-153D	Cutler-Hammer/Westinghouse Type FDP & M50 Fusible Panelboard Switch 400/600 A Single	178	RSA-164K	Square D MCCB PowerPact R Frame 600-3000 A	189
RSA-153F	Cutler-Hammer/Westinghouse Type FDP & M50 Fusible Panelboard Switch 800/1200 A Single, 90° of Handle Travel, for Horizontal Unit, Switch Located On Middle Left-Hand Side	178	RSA-164R	Square D MCCB PowerPact B Frame (includes BD, BG, BJ, BK) 15-125 A	189
RSA-154A	ITE/Siemens Panelboard Switch High Contact Pressure Switch HCPXXXX	179	RSA-166	Square D Safety Switch Heavy Duty Safety Switch 30 A, H, HU-221, 321, 361-N/A, N, NRB, RB, A, AWK (Series F5 & F6)	189
RSA-154B	Siemens Panelboard Switch Vacu-Break Fusible Panel Units V2EXXX/V7EXXX	179	RSA-166A	Square D Safety Switch Heavy Duty Safety Switch 200 A, H, HU-224, 324, 364, 464, 664-N/A, N, NRB, RB, A, AWK (Series F5 & F6)	190
RSA-154C	Siemens Panelboard Switch Vacu-Break Fusible Panel Units V2FXXXX/V7FXXXX	179	RSA-166B	Square D Heavy-Duty Safety Switch 200 A H/ HU-224/324/364/464-N/A, N, NRB, RB, A, AKW	190
RSA-154D	Siemens Panelboard Switch Vacu-Break Fusible Panel Units V2HXXXX/V7HXXXX	180	RSA-166D	Square D Safety Switch Heavy Duty Safety Switch 240 & 600 V; 400, 600, 800, & 1200 A (Series E4 & E5 Only)	190
RSA-154F	Siemens Panelboard Switch Vacu-Break Fusible Panel Units Main Switch VF357/VB357/VF358/VB358	180	RSA-166E	Square D Safety Switch Heavy Duty Safety Switch 60 & 100 A, H, HU-222, 223, 322, 323, 363, 363, 462, 463-N/A, N, NRB, RB (Series F5 & F6)	191
RSA-154G	ITE/Siemens Panelboard Switch Vacu-Break Fusible Panel Units V2BXXX, V7BXXXX	180	RSA-166G	Square D Heavy-Duty Safety Switch 30/60 A H/ HU-221/222/321/322/361-DS	191
RSA-155	Square D ICCB SE Series (All)	181	RSA-167	Allen-Bradley MCC 1494F-P1-NP Series A Nonmetallic Molded Plastic Operating Handle	191
RSA-155A	Square D ICCB SEF/SED - All Sizes	181	RSA-168	GE Heavy Duty Safety Switch Type TC 800 & 1200 A; NEMA Type 1 & 3R; Models 7,8,9,10	192
RSA-157	Cooper Substation VFI Transformer	181	RSA-169	GE THN Series Heavy Duty Safety Switch, Operates Catalog Number THN3321, 30 A/240 VAC/250 VDC	192
RSA-158	Siemens ICCB Type WN/WL/3WN/3WL Low-Voltage ACB	182	RSA-169A	GE Heavy-Duty Safety Switch TH Series	192
RSA-158A	Siemens ICCB WL - All Sizes	182	RSA-169C	GE Heavy Duty Safety Switches Listed in Drawing Number 10103091SH112, NEMA Type 1 enclosure, 400-600 A	193
RSA-159	Square D MCC Class 8198 High-Voltage Motor Starter	182	RSA-169D	TG Series General Duty Safety Switch 200 A, 240 VAC	193
RSA-160	GE Spectra Type ADS Panelboard Disconnect Switch 30/60/100/200 A	183	RSA-169F	GE TH Series General Duty Safety Switch, 30 A, 240 VAC	193
RSA-160C	GE Spectra Type ADS Panelboard Disconnect Switch 400/600 A	183	RSA-174E	ABB/SACE Tmax MCCB Size T7M 1000/1200 A Frame	194
RSA-160D	GE Spectra Type ADS Panelboard Disconnect Switch 800/1200 A	183	RSA-174F	ABB/SACE Tmax MCCB Size T7 1000-1600 A Frame	194
RSA-161A	Square D Through-the-Door Handle Operator Class 9421 Type L CB Mechanism	184	RSA-175B	FPE MCCB J Frame 70-225 A	194
RSA-161A	Square D Rotary Handle Class 9421 Type L Circuit Breaker Mechanism	184	RSA-175E	FPE MCCB M Frame 150-800 A	195
RSA-162	GE ACB EntelliGuard G	184	RSA-176A	Schneider Electric/Square D Vacuum Circuit Breaker Type VR 1200-3000 A	195
RSA-162A	GE ACB EntelliGuard G 400-6000 A, GG/GJ/GH/GK-04/07/08/10/13/16/20/25/32/40/50/64	185	RSA-177	FPE QMQB Panelboard Switch 30-100 A Single or Twin	195
RSA-163	ABB/Siemens Flange Handle Operator K7FCH/K7FCH4 & Max-Flex Handle Operator MFHM Series	185	RSA-177A	FPE QMQB Panelboard Switch 200 A Single	196
RSA-163A	ABB/Siemens Flange Handle Operator K7FHD-HS12/K7FHD-HS4	185	RSA-177C	FPE QMQB Panelboard Switch 800-1200 A Single	196
RSA-163C	ABB/Siemens Flange Handle Operator OHF1C4, OHF1C12	186	RSA-180	Merlin Gerin/Square D ICCB Masterpact NT (All)	196
RSA-163D	ABB/Siemens Flange Handle Operator K7FCH/K7FCH4 & Max-Flex Handle Operator MFHM Series	186	RSA-180A	Schneider Electric/Square D ICCB Masterpact NT - All Sizes	197
RSA-164B	Square D MCCB PowerPact E Frame 15-125 A	186	RSA-181	Square D Bolted Pressure Switch Manually Operated Type Bolt-Loc BL Series & Type AV Switch AVO Series with AVFQ/AVSQ Handle Operator	197
RSA-164C	Square D MCCB PowerPact H Frame 15-150 A	187	RSA-183	GE Flange Handle Operator STDA1	197
			RSA-183A	GE Flange Handle Operator STDA2	198
			RSA-184	Cutler-Hammer FDPW Fusible Panelboard Switch 30/60/100 A Twin	198
			RSA-184C	Cutler-Hammer FDPW Panelboard Switch 200 A Single	198

<b>RSA/RSK NUMBER</b>	<b>MANUFACTURER/EQUIPMENT</b>	<b>PAGE</b>	<b>RSA/RSK NUMBER</b>	<b>MANUFACTURER/EQUIPMENT</b>	<b>PAGE</b>
RSA-184D	Cutler-Hammer FDPW Fusible Panelboard Switch 400 A Single	199	RSA-205B	Siemens Oversized HF361RL, HNF361RL, HF222NR, HF322NR, HF262R, HF362R, HF362NR, HNF262NR, HNF362NR Safety Switch	209
RSA-184F	Cutler-Hammer FDPW Fusible Panelboard Switch 600/800 A Single	199	RSA-205C	Siemens HF364NR, HF364R, RPV, RPVPG Safety Switch	209
RSA-185	Square D Model 5 MCC Bucket Size 1-5	199	RSA-205G	Siemens NRH425-1, F355 Safety Switch	210
RSA-186	Westinghouse LBS Type ADM Disconnect Switch	200	RSA-209	GE ACB Type AL Manually Operated up to 1600 A	210
RSA-187	GE MCCB K Line 1200 A Frame Size, Flush Mounted, with Lockout-Tagout Device Installed	200	RSA-210	Klockner Moeller/Moeller Electric Door Coupling Handle Operator for PKZM 0/PKZM 01/PKZM 4 Breaker	210
RSA-187A	GE MCCB E Line 150 A Frame Size TE/TEB/TEC/TECL/TED/TEML/THED	200	RSA-211	Eaton Heavy Duty Fusible/Non-Fusible Low Voltage Safety Switch 30 A	211
RSA-187B	GE MCCB F Line 225 A Frame Size THFK/TF/TFC/TFJ/TFK/TFL	201	RSA-211A	Cutler-Hammer/Eaton Heavy Duty Fusible/Nonfusible Low-Voltage Safety Switch	211
RSA-187C	GE MCCB J Line 600 A Frame Size THJK/TJ/TJC/TJD/TJJ/TJK/TJL	201	RSA-213A	Metron Handle Operator Electric Fire Pump Controller Series M200/M300/M400/M420/M430/M435/M450/M700	211
RSA-187F	GE MCCB F Line 225 A Frame Size Type THFK/TF/TFC/TFJ/TFK/TFL (Recessed Mounted)	201	RSA-217	GE ACB Type AMH 1200-2000 A	212
RSA-187G	GE MCCB J Line 600 A Frame Size THJK/TJ/TJC/TJD/TJJ/TJK/TJL	202	RSA-218A	FPE Low-Voltage Circuit Breaker S4/S5 30/50/75 (800-3200 A)	212
RSA-187H	GE MCCB K Line 1200 A Frame Size THKM/TKC/TKL/TKM	202	RSA-221C	Cutler-Hammer/Eaton Type SM Safety Handle Mechanism for MCCB Series C L Frame	212
RSA-187I	GE MCCB THLC2 Series 175-400 A Frame Size Type THLC2 & THLC4 series	202	RSA-222	Eaton/Cutler Hammer Flex Shaft Flange Mounted Handle Mechanism (4" Handle)	213
RSA-187J	GE MCCB Type TEY MCCB 10-100 A, includes Pole	203	RSA-222D	Eaton/Cutler Hammer Flex Shaft Flange Mounted Handle Mechanism (4" Handle, Stainless Steel Enclosure)	213
RSA-188B	GE AV Line Switchboard Rotary Operating Handle	203	RSA-222E	Eaton/Cutler Hammer Flex Shaft Flange Mounted Handle Mechanism (8.25" Handle on Recessed Application)	213
RSA-188C	GE AV Line Switchboard Rotary Operating Handle for Individually Mounted Devices/Branch Fusible Switch or Branch Circuit Breaker	203	RSA-224	Cutler-Hammer/Eaton Low-Voltage Pow-R-Way/Pow-R-Way II/Pow-R-Way III Busway System Plug-In Device IPB-MC 100-200 A Bus Plug	214
RSA-189	Cutler-Hammer MCC F10 Unitrol/9800 Unitrol Lever Size 1-4	204	RSA-227	Cutler-Hammer/Eaton Universal Rotary Handle Mechanism for MCCB Series C/G	214
RSA-192E	ABB Handle Operator OHY/OHB/OHG	204	RSA-228	FPE Low-Voltage ACB 12/16/20/32/40PL for Nonmagnetic Switchgear	214
RSA-195A	GE MCCB Tri-Break (Fused) TB Frame Size TB4/TBC4	204	RSA-230B	Cutler-Hammer/Eaton MCCB Series G LG Frame 100-630 A 240-600 V AC 1-4 Pole, Flush Mounted, includes LG/LGE/LGS/LGH/LGC/LGU/LGX	215
RSA-196	GE MCCB ZJ8 Link Operated Air Switch	205	RSA-233	Terasaki/Hyundai ACB TemPower Type 630-4000 A & HAT 630-5000 A	215
RSA-197E	ITE/Gould/Bulldog/Siemens Vacu-Break Heavy Duty Safety Switch Type 1	205	RSA-233A	Terasaki/Hyundai ACB TemPower Type AT Low Voltage 630-4000 A & HAT Low-Voltage 630-5000 A	215
RSA-198	ABB Rotary Handle Operator, Variable Depth, Square Type 1 K2VD-H for ABB Isomax S1 Frame MCCB	205	RSA-242	ABB/SACE Novamax ACB (All)	216
RSA-198A	ABB Rotary Handle Operator, Variable Depth, Square Type 1 K5VD-H for ABB Isomax S3/S4/S5 Frame MCCB & K7VD-H for ABB Isomax S6/S7 Frame MCCB, Direct Mount, Rotary Handle Operating Mechanism K5RH for ABB Isomax S3/S4/S5 Frame MCCB	206	RSA-243	GE Handle Operator SE100CS/TE100CS Breaker Switch NEMA Type4, 4X Enclosure; TE/SE Series Breakers	216
RSA-200A	Kraus & Naimer Selector Switch Size S1 With "F" Type Handle	206	RSA-243A	GE Handle Operator SG400CS Breaker Switch NEMA Type 4, 4X Enclosure; Spectra G Series Breakers	216
RSA-200B	Kraus & Naimer Selector Switch Size S1 With F221 Face Configuration for Label at Top, Handle Type "O" Model G412	206	RSA-244	Motortronics Medium-Voltage Soft Starter MVC Plus, Overall Handle Length 7"	217
RSA-201	Square D Enclosed CB Type NEMA 12/3R/Series E3 100-600 A & 300-1000 A	207	RSA-244A	Motortronics Medium-Voltage Soft Starter MVC Plus, Overall Handle Length 14.125"	217
RSA-201B	Square D Enclosed CB Type NEMA 3, 3R, 4, 4X, 5, 12 Housed in an M800SS (Stainless Steel) Enclosure	207	RSA-247	R & IE LIS	217
RSA-202	ABB SF6 CB HGI 2/HGI 3 Generator 17.5-24 kV 6300-8000 A	207	RSA-249	S&C LIS Type MS Medium-Voltage	218
RSA-203	GE ACB Type M-PACT Low-Voltage	208	RSA-250	Merlin Gerin COMPACT NS MCCB	218
RSA-204	Rockwell Automation/Allen Bradley Bulletin 1494R Variable Depth Door Mounted Rotary Disconnect Switch 30-60 A	208	RSA-251	Schneider Electric/Square D Blockset Rotary Handle Actuator	218
RSA-204A	Rockwell Automation/Allen Bradley Bulletin 1494R Variable Depth Door Mounted Rotary Disconnect Switch 100-200 A	208	RSA-252	L&T DN2 MCCB Rotary Handle Actuator	219
RSA-205	Bulldog/ITE/Siemens General Duty Enclosed Safety Switch	209	RSA-252A	L&T DSINE ROH DM Rotary Handle Actuator	219
			RSA-265A	Eaton NRX NF Frames 200-1200 A and IEC IZMX16 630 A, 800 A, 1000 A, 1250 A, 1600 A	219

<b>RSA/RSK NUMBER</b>	<b>MANUFACTURER/EQUIPMENT</b>	<b>PAGE</b>	<b>RSA/RSK NUMBER</b>	<b>MANUFACTURER/EQUIPMENT</b>	<b>PAGE</b>
RSA-265B	Eaton NRX RF Frames 1600-3000 A and IEC IZMX16 800 A, 1000 A, 1250 A, 1600 A, 2000 A, 2500 A, 3200 A, 4000 A	220	RSK-AK14	GE ACB Type AKR 800-2000 A	235
RSA-267	S&C PMH-9/PME Pad Mounted Mini-Rupter Switch	220	RSK-BBC5	ABB/BBC/ITE ACB Type LK25 2500 A	235
RSA-269	ABB/ITE/BBC HK Style With Hook Latch Close and Push Button Trip	220	RSK-BL30W	Siemens MCCB Type BL, BLH, Single Pole 10-70 A	235
RSA-270	Eaton/Cutler Hammer/Westinghouse JLDN600, RLDN600, WLDN600, JNDN1200, RNDN1200, and WNDN1200 Circuit Breaker Enclosures, 600-1200 A, Not for Stainless Steel Enclosures	221	RSK-CHLIW	Eaton/Cutler-Hammer/Westinghouse 2100/Freedom/Five Star/Advantage Series LVMCC Sizes 1-4 Buckets	236
RSA-270B	Eaton/Cutler-Hammer/Westinghouse HF361, HF322 Circuit Breaker Enclosure With Raised Face, Large Rubberized Handle, 100 A	221	RSK-CS01W	Electroswitch Series 24/24P; GE SB/SBM/SB-1/SB-9/SB-10; Type W, Shallco Series 26	236
RSA-271	Eaton S01 Universal Rotary Handle	221	RSK-CS03W	ITI Control Switch Series 95	236
RSA-271A	Eaton G-EG/JG/LG Universal Rotary Handle	222	RSK-CS04W	Electroswitch Series 20 Control Switch	237
RSA-272	Cooper Type CM Fault Interrupter	222	RSK-CS05	Electroswitch Control Switch Series 20	237
RSA-275	Square D Class 9810 Series Type TS Three-Position Switch	222	RSK-CS06	Cutler-Hammer Control Switch Model L2R120CW	237
RSA-276	Gould/ITE HS3B MCCB 2500 A and Above	223	RSK-CS07	Electroswitch Control Switch Series 31, Common on Siemens RL Switchgear	238
RSA-277	Challenger HDN365 Safety Switch 400 A	223	RSK-DS10	Cutler-Hammer/Square D/Westinghouse ACB Type DS (All)	238
RSA-278	Continental LVMCC Size 1-4 Close/Trip Actuator, Small Handle	223	RSK-GEPB1	GE ACB Power Break	238
RSA-279	Eaton-Moeller NZM4 Door Coupling Rotary Handle	224	RSK-GEPBIE	GE ACB Power Break	239
RSA-280	TornaTech GP Series Fire Pump Controller	224	RSK-GEPBIL	GE ACB Power Break	239
RSA-281	Nelson Electric Class 1035E LVMCC Rotary Handle Operator	224	RSK-GEPB2	GE ACB Power Break II	239
RSA-282	Bentek 1500 V UTS2 for 1500 VDC Integrated Disconnect String Combiner for Grounded PV Systems, 200-400 A	225	RSK-IMPB1	Engineering Intelligent Medium Powerbar Tap-off Disconnect Box Switch Type W-2	240
RSA-283	ABB ADVAC or RMVAC MV Retrofit for 5 or 15 kV Breakers	225	RSK-K15	ABB/BBC/ITE ACB K-Line	240
RSA-286	Siemens 3VA64 Series MCCB 450, 500, 600 A Frame Sizes	225	RSK-K20	ABB/BBC/ITE ACB K-Line	240
RSA-287	ABB/SACE Tmax XT1 Frame, 125 A Flush Mounted	226	RSK-LA12	Allis-Chalmers/Siemens-Allis ACB Type LA/LAF 1600-2000 A	241
RSA-287D	ABB/SACE Tmax XT5 Frame, 400-600 A, Flush Mounted	226	RSK-MBSW1	GE Magne-Blast Raise/Lower Toggle Switches	241
RSA-287E	ABB/SACE Tmax XT6 Frame, Withdrawable MCCB, 800 A, Flush Mounted	226	RSK-MDS30	Cutler-Hammer/Eaton ICCB Type Magnum DS/SB	241
RSA-288	Mitsubishi WS-V Series Rotary Handle, 62mm Diameter, 30-250 A Frame Size	227	RSK-NT20	Merlin Gerin/Square D Masterpact NT (All)	242
RSA-289	Unelec CNX LVACB With Charging Handle	227	RSK-NW20	Merlin Gerin/Square D Masterpact NW (All)	242
RSA-292	EBG Disconnect Switch, Rotary	227	RSK-P11W	Square D I-Line MCCB - P Frame 600-2500 A, Flush Mounted	242
RSA-293	GEC Alsthom Rotary Style Load Switch	228	RSK-PB16	Various, Miscellaneous Single Push Buttons	243
RSA-294	Elmex Disconnect Switch, Rotary 180-270°	228	RSK-RL12	Siemens/Siemens-Allis ACB Type RL/RLE/RLF 3200-5000 A	243
RSA-295	Elmex Load Break Switch, Lever Style	228	RSK-SACE1	ABB/SACE ACB Type E3S-A	243
RSA-296	Square D Disconnect Switch, Rotary	229	RSK-SACE2	ABB/SACE ACB Type S 1600	244
RSA-297	Square D S-2 Load Break Switch, Lever Style	229	RSK-SBH2	Siemens ICCB Type SB/SBA/SBS	244
RSK-ABL1W	Allen-Bradley CENTERLINE 2100 MCC Sizes 1-4 Bucket (Black or Gray Plastic Handle)(LVMCC)	233	RSK-SDL6C	Square D Model 6 MCC with 4.0" Handles, Model Year 2006 and Newer	244
RSK-ABL2W	Allen Bradley CENTERLINE 2100 and Bulletin 1200 MCC Main Buckets with Large Handles	233	RSK-SDL6W	Square D Model 6 MCC legacy with 4.5" Handles, Model Year Pre-2006	245
RSK-ABL3W	Rockwell Automation/Allen-Bradley CENTERLINE 1500 Series 5 kV Starter	233	RSK-SE06	Square D ICCB SE Series (All)	245
RSK-AK11	GE ACB Type AKR-6/10D-30/50 & AKR-4/5-B-30/50, Requires Bracket	234	RSK-SPB1	Cutler-Hammer/Westinghouse/Eaton ICCB Type SPB Systems Pow-R 250-3000 A	245
RSK-AK12	GE ACB Type AKR-6/10D-75/100	234	RSK-SPB2	Cutler-Hammer/Westinghouse/Eaton ICCB Type SPB Systems Pow-R 250-3000 A	246
RSK-AK13	GE ACB Type AK 1600-3200 A	234	RSK-WAV21	GE ACB WavePro 800-2000 A & EntelliGuard 800-2000 A	246
			RSK-WL01	Siemens ACB Type WL 800-6000 A	246
			RSK-WL01R	Siemens ACB Type WL 800-6000 A with Siemens Racking Rails	247

\*All unit measurements are L x W x H

# RSA-1

FOR USE WITH:

**Electroswitch/General Electric/Westinghouse/Instrument Transformers Inc./Shallco Breaker Control Switch**

## SPECIFICATIONS

OPERATION: Close/Trip

WEIGHT: 4.0 lbs.

DIMENSIONS: 10.0" x 6.7" x 7.8"

COMPATIBLE WITH: Electroswitch Series 24, 24P; General Electric SB-1, SB-9, SB-10, SBM; Westinghouse Type W; Instrument Transformers Inc. Series 95; Shallco Series 26

CONTROL/POWER SOURCE: RSO-IAR-M18



# RSA-1A

FOR USE WITH:

**Electroswitch Breaker Control Switch**

## SPECIFICATIONS

OPERATION: Close/Trip

WEIGHT: 4.0 lbs.

DIMENSIONS: 10.0" x 6.7" x 7.8"

COMPATIBLE WITH: Series 20

CONTROL/POWER SOURCE: RSO-IAR-M18



# RSA-1B

FOR USE WITH:

**Electroswitch/Westinghouse Breaker Control Switch**

## SPECIFICATIONS

OPERATION: Close/Trip

WEIGHT: 4.5 lbs.

DIMENSIONS: 10.0" x 6.7" x 7.8"

COMPATIBLE WITH: Type W-2

CONTROL/POWER SOURCE: RSO-IAR-M18



\*All unit measurements are L x W x H

# RSA-1C

FOR USE WITH:  
**Electroswitch  
Breaker Control Switch**

## SPECIFICATIONS

**OPERATION:** Close/Trip

**WEIGHT:** 6.1 lbs.

**DIMENSIONS:**\* 11.0" x 6.5" x 2.9"

**COMPATIBLE WITH:** Series 31, 101  
Switches with Oval Shank Operator

**CONTROL/POWER SOURCE:**  
RSO-IAR-M18



# RSA-1D

FOR USE WITH:  
**UK Switch  
Breaker Control Switch**

## SPECIFICATIONS

**OPERATION:** Close/Trip

**WEIGHT:** 5.1 lbs.

**DIMENSIONS:**\* 10.0" x 7.7" x 4.9"

**COMPATIBLE WITH:** UK Switch  
Breaker Control Switch

**CONTROL/POWER SOURCE:**  
RSO-IAR-M18

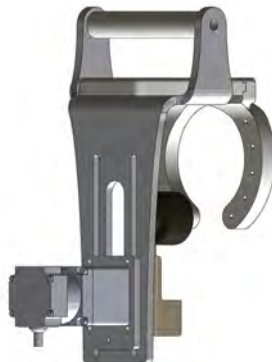

# RSA-1E

FOR USE WITH:  
**Electroswitch/General Electric/Westinghouse/  
Instrument Transformers Inc./Shallco  
Breaker Control Switch**

## SPECIFICATIONS

**OPERATION:** Close/Trip

**WEIGHT:** 5.3 lbs.

**DIMENSIONS:**\* 11.6" x 5.5" x 7.7"

**COMPATIBLE WITH:** Electroswitch Series 24, 24P; General Electric SB-1, SB-9, SB-10, SBM; Westinghouse Type W; Instrument Transformers Inc. Series 95; Shallco Series 26 with lights or other interference issues directly above the top of the switch base

**CONTROL/POWER SOURCE:** RSO-IAR-M18



\*All unit measurements are L x W x H

# RSA-1F

FOR USE WITH:

**General Electric  
Breaker Control Switch**

## SPECIFICATIONS

OPERATION: Close/Trip

WEIGHT: 13.0 lbs.

DIMENSIONS: \* 16.4" x 10.4" x 13.9"

COMPATIBLE WITH: Type SB-1,  
SB-9, SB-10 - Pull to Operate

CONTROL/POWER SOURCE:  
RSO-IAR-M18



# RSA-1H

FOR USE WITH:

**Cutler-Hammer  
Breaker Control Switch**

## SPECIFICATIONS

OPERATION: Close/Trip

WEIGHT: 6.6 lbs.

DIMENSIONS: \* 8.5" x 3.3" x 6.4"

COMPATIBLE WITH: Type 10250T,  
E34

CONTROL/POWER SOURCE:  
RSO-IAR-M18



# RSA-1J

FOR USE WITH:

**General Electric  
Breaker Control Switch**

## SPECIFICATIONS

OPERATION: Close/Trip

WEIGHT: 3.1 lbs.

DIMENSIONS: \* 3.7" x 3.1" x 5.9"

COMPATIBLE WITH: Type CR104P  
3 Position Spring Loaded Switch

CONTROL/POWER SOURCE:  
RSO-IAR-M18



\*All unit measurements are L x W x H

# RSA-1M

FOR USE WITH:  
**Cutler-Hammer  
Breaker Control Switch**

## SPECIFICATIONS

**OPERATION:** Close/Trip  
**WEIGHT:** 10.0 lbs.  
**DIMENSIONS:\*** 9.5" x 4.3" x 6.4"  
**COMPATIBLE WITH:** Type  
2A96112HXX  
**CONTROL/POWER SOURCE:**  
RSO-IAR-M18



# RSA-2

FOR USE WITH:  
**ALL MANUFACTURERS  
Push Button**

## SPECIFICATIONS

**OPERATION:** Push Button  
**WEIGHT:** 2.7 lbs.  
**DIMENSIONS:\*** 8.0" x 4.0" x 6.6"  
**COMPATIBLE WITH:** Push Button  
(All Manufacturers and Gear,  
0.500" Max Travel, 10 lbf Max  
Force)  
**CONTROL/POWER SOURCE:**  
RSO-IAR-M18



# RSA-2B

FOR USE WITH:  
**ALL MANUFACTURERS  
Push Button**

## SPECIFICATIONS

**OPERATION:** Push Button  
**WEIGHT:** 5.8 lbs.  
**DIMENSIONS:\*** 6.9" x 3.1" x 7.0"  
**COMPATIBLE WITH:** Push Button  
(All Manufacturers and Gear,  
0.500" Max Travel, 10 lbf Max  
Force)  
**CONTROL/POWER SOURCE:**  
RSO-IAR-M18

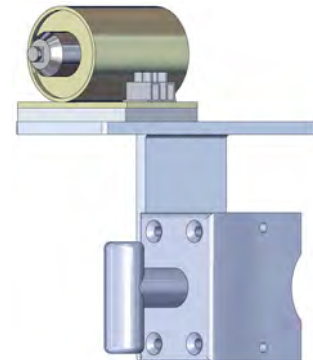

\*All unit measurements are L x W x H

# RSA-2D

FOR USE WITH:  
**ALL MANUFACTURERS  
Push Button**

## SPECIFICATIONS

OPERATION: Push Button

WEIGHT: 10.4 lbs.

DIMENSIONS:\* 6.1" x 20.7" x 5.1"

COMPATIBLE WITH: Dual Push Button (All Manufacturers and Gear, 0.500" Max Travel, 10 lbf Max Force)

CONTROL/POWER SOURCE:  
RSO-IAR-M18



# RSA-2HD

FOR USE WITH:  
**ALL MANUFACTURERS  
Push Button**

## SPECIFICATIONS

OPERATION: Push Button

WEIGHT: 6.5 lbs.

DIMENSIONS:\* 9.2" x 2.0" x 7.3"

COMPATIBLE WITH: Push Button (All Manufacturers and Gear, 2.0" Max Travel, 50 lbf Max Force)

CONTROL/POWER SOURCE:  
RSO-IAR-M18



# RSA-7

FOR USE WITH:  
**Westinghouse  
Motor Control Center**

## SPECIFICATIONS

OPERATION: Close/Trip

WEIGHT: 7.5 lbs.

DIMENSIONS:\* 12.1" x 6.0" x 4.8"

COMPATIBLE WITH: Type W Motor Control Center (MCC) Bucket, Size 1-4 (Small Handle Operator)

CONTROL/POWER SOURCE:  
RSO-IAR-M18



\*All unit measurements are L x W x H

# RSA-7A

FOR USE WITH:

**Westinghouse  
Motor Control Center**

## SPECIFICATIONS

**OPERATION:** Close/Trip

**WEIGHT:** 14.2 lbs.

**DIMENSIONS:**\* 23.6" x 8.3" x 8.9"

**COMPATIBLE WITH:** Type W  
Motor Control Center (MCC)  
Bucket, Size 1-4 (Medium Handle  
Operator)

**CONTROL/POWER SOURCE:**  
RSO-IAR-M18



# RSA-7B

FOR USE WITH:

**Westinghouse  
Motor Control Center**

## SPECIFICATIONS

**OPERATION:** Close/Trip

**WEIGHT:** 14.0 lbs.

**DIMENSIONS:**\* 24.1" x 7.6" x 4.6"

**COMPATIBLE WITH:** Type W  
Motor Control Center (MCC)  
Bucket, Size 5 (Large Handle  
Operator)

**CONTROL/POWER SOURCE:**  
RSO-IAR-M18



# RSA-8

FOR USE WITH:

**General Electric  
Motor Control Center**

## SPECIFICATIONS

**OPERATION:** Close/Trip

**WEIGHT:** 10.0 lbs.

**DIMENSIONS:**\* 9.5" x 5.4" x 6.9"

**COMPATIBLE WITH:** Type 7700 Motor  
Control Center (MCC) Bucket, Size 1-4  
(Handle Operator) & Type TDR Integral  
Handle Mechanism (2.94" Diameter,  
SE150 & SF250 Line)

**CONTROL/POWER SOURCE:**  
RSO-IAR-M18



\*All unit measurements are L x W x H

# RSA-8A

FOR USE WITH:

**General Electric  
Motor Control Center**

## SPECIFICATIONS

OPERATION: Close/Trip

WEIGHT: 14.1 lbs.

DIMENSIONS: \* 11.4 x 6.1 x 6.8"

COMPATIBLE WITH: Type 7700 Motor Control Center (MCC) Bucket, Size 5 (Handle Operator) & Type TDR Integral Handle Mechanism (4.75" Diameter, SG600 Line)

CONTROL/POWER SOURCE: RSO-IAR-M18



# RSA-8B

FOR USE WITH:

**General Electric  
Handle Operator**

## SPECIFICATIONS

OPERATION: Close/Trip

WEIGHT: 16.0 lbs.

DIMENSIONS: \* 10.7" x 8.5" x 10.7"

COMPATIBLE WITH: Type TDR Integral Handle Mechanism (6.0" Diameter, SK1200 Line)

CONTROL/POWER SOURCE: RSO-IAR-M18



# RSA-9B

FOR USE WITH:

**General Electric  
Motor Control Center**

## SPECIFICATIONS

OPERATION: Close/Trip

WEIGHT: 24.4 lbs.

DIMENSIONS: \* 21.3" x 8.5" x 8.2"

COMPATIBLE WITH: Limitamp Medium-Voltage Controller - CR194, CR7160, CR7161 Series (without Kirk Lock)

CONTROL/POWER SOURCE: RSO-IAR-M18



\*All unit measurements are L x W x H

# RSA-9C

FOR USE WITH:  
**General Electric  
Motor Control Center**

## SPECIFICATIONS

**OPERATION:** Close/Trip

**WEIGHT:** 20.0 lbs.

**DIMENSIONS:\*** 17.6" x 8.0" x 10.1"

**COMPATIBLE WITH:** Limitamp Medium-Voltage Controller - CR194, CR7160, CR7161 Series (Right Side Mount); Limitamp Medium-Voltage Controller CR194 CR7160 CR7161 (Kirk Key Mounted on LH Side of the Switch)

**CONTROL/POWER SOURCE:**  
RSO-IAR-M18

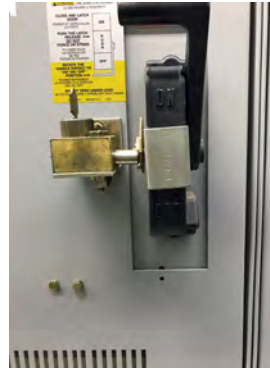

# RSA-9E

FOR USE WITH:  
**General Electric  
Motor Control Center**

## SPECIFICATIONS

**OPERATION:** Close/Trip

**WEIGHT:** 29.0 lbs.

**DIMENSIONS:\*** 16.4" x 12.9" x 8.4"

**COMPATIBLE WITH:** Limitamp Medium-Voltage Controller - CR194, CR7160, CR7161 (Right Side Mount with Electric Interlock Defeat)

**CONTROL/POWER SOURCE:**  
RSO-II



# RSA-9R

FOR USE WITH:  
**General Electric  
Motor Control Center**  
*(Manual Interlock Defeat version)*

## SPECIFICATIONS

**OPERATION:** Close/Trip

**WEIGHT:** 23.4 lbs.

**DIMENSIONS:\*** 14.3" x 13.7" x 7.1"

**COMPATIBLE WITH:** Limitamp Medium-Voltage Controller (Vertical Rotary Handle Operator)

**CONTROL/POWER SOURCE:**  
RSO-IAR-M18



\*All unit measurements are L x W x H

# RSA-9R

FOR USE WITH:

## General Electric Motor Control Center

*(Remote/Electric Interlock Defeat version)*

### SPECIFICATIONS

OPERATION: Close/Trip

WEIGHT: 25.8 lbs.

DIMENSIONS:\* 15.0" x 13.7" x 12.9"

COMPATIBLE WITH: Limitamp  
Medium-Voltage Controller  
(Vertical Rotary Handle Operator)

CONTROL/POWER SOURCE:  
RSO-IAR-M18



# RSA-10

FOR USE WITH:

## Westinghouse/Cutler-Hammer Motor Control Center

### SPECIFICATIONS

OPERATION: Close/Trip

WEIGHT: 24.0 lbs.

DIMENSIONS:\* 20.7" x 11.2" x 6.5"

COMPATIBLE WITH: Ampguard  
Legacy Style Handle Operator  
1958-2004

CONTROL/POWER SOURCE:  
RSO-IAR-M18



# RSA-10A

FOR USE WITH:

## Eaton/Cutler-Hammer Motor Control Center

### SPECIFICATIONS

OPERATION: Close/Trip

WEIGHT: 16.0 lbs.

DIMENSIONS:\* 14.5" x 8.3" x 9.8"

COMPATIBLE WITH: Ampguard  
Current Style Handle Operator

CONTROL/POWER SOURCE:  
RSO-IAR-M18



\*All unit measurements are L x W x H

# RSA-10F

FOR USE WITH:  
**Eaton/Cutler-Hammer  
Motor Control Center**

## SPECIFICATIONS

**OPERATION:** Close/Trip  
**WEIGHT:** 18.0 lbs.  
**DIMENSIONS:**\* 14.5" x 4.9" x 9.0"  
**COMPATIBLE WITH:** Ampgard  
**CONTROL/POWER SOURCE:**  
RSO-IAR-M18



# RSA-11

FOR USE WITH:  
**Westinghouse  
Air Circuit Breaker**



## SPECIFICATIONS

**OPERATION:** Close/Trip  
**WEIGHT:** 12.0 lbs.  
**DIMENSIONS:**\* 8.9" x 12.0" x 8.3"  
**COMPATIBLE WITH:** Type DHP  
1200-3000 A  
**CONTROL/POWER SOURCE:**  
RSO-IAR-M18



# RSA-11B

FOR USE WITH:  
**Westinghouse  
Air Circuit Breaker**

## SPECIFICATIONS

**OPERATION:** Close Only  
**WEIGHT:** 10.0 lbs.  
**DIMENSIONS:**\* 9.0" x 7.3" x 8.3"  
**COMPATIBLE WITH:** Type DHP 1200-  
3000 A - Close Only  
**CONTROL/POWER SOURCE:**  
RSO-IAR-M18



\*All unit measurements are L x W x H

# RSA-12A

## SPECIFICATIONS

OPERATION: Charge/Close/Trip

WEIGHT: 30.0 lbs.

DIMENSIONS:\* 15.3" x 15.7" x 7.6"

COMPATIBLE WITH: Type DS, DSII, DSL, DSLII

CONTROL/POWER SOURCE: RSO-IIID-M18

FOR USE WITH:

**Cutler-Hammer/Square D/Westinghouse  
Air Circuit Breaker**



# RSA-12B

## SPECIFICATIONS

OPERATION: Close/Trip

WEIGHT: 10.0 lbs.

DIMENSIONS:\* 7.4" x 4.5" x 6.4"

COMPATIBLE WITH: Type DS, DSII, DSL, DSLII

CONTROL/POWER SOURCE: RSO-IIID-M18

FOR USE WITH:

**Cutler-Hammer/Square D/Westinghouse  
Air Circuit Breaker**



# RSA-12C

## SPECIFICATIONS

OPERATION: Close/Trip

WEIGHT: 14.0 lbs.

DIMENSIONS:\* 8.9" x 15.0" x 6.0"

COMPATIBLE WITH: Type DS, DSII, DSL, DSLII

CONTROL/POWER SOURCE: RSO-IIID-M18

FOR USE WITH:

**Cutler-Hammer/Square D/Westinghouse  
Air Circuit Breaker**



\*All unit measurements are L x W x H

# RSA-14

FOR USE WITH:

**Siemens  
Motor Control Center**

## SPECIFICATIONS

**OPERATION:** Close/Trip

**WEIGHT:** 22.0 lbs.

**DIMENSIONS:**\* 14.8" x 9.3" x 7.8"

**COMPATIBLE WITH:** Type 81000  
Medium-Voltage Controller

**CONTROL/POWER SOURCE:**  
RSO-IAR-M18



# RSA-14A

FOR USE WITH:

**Siemens  
Motor Control Center**

## SPECIFICATIONS

**OPERATION:** Close/Trip

**WEIGHT:** 22.0 lbs.

**DIMENSIONS:**\* 15.7" x 9.3" x 7.8"

**COMPATIBLE WITH:** Type 81000  
Medium-Voltage Controller (Flush  
Mount)

**CONTROL/POWER SOURCE:**  
RSO-IAR-M18



# RSA-14B

FOR USE WITH:

**Siemens  
Motor Control Center**

## SPECIFICATIONS

**OPERATION:** Close/Trip

**WEIGHT:** 26.0 lbs.

**DIMENSIONS:**\* 14.9" x 7.0" x 11.9"

**COMPATIBLE WITH:** Type 81000  
Medium-Voltage Controller (with DC  
Door on Panel and Latch Directly  
Above Switch)

**CONTROL/POWER SOURCE:**  
RSO-IAR-M18



\*All unit measurements are L x W x H

# RSA-15

FOR USE WITH:

**Siemens**  
**Motor Control Center**

## SPECIFICATIONS

**OPERATION:** Close/Trip

**WEIGHT:** 21.8 lbs.

**DIMENSIONS:**\* 21.5" x 6.7" x 11.6"

**COMPATIBLE WITH:** SimoVac Medium-Voltage Controller (Straight Handle Style with Black Plastic Knob on End of Isolation Switch)

**CONTROL/POWER SOURCE:**  
RSO-IAR-M18



# RSA-16

FOR USE WITH:

**Siemens**  
**Insulated Case Circuit Breaker**

## SPECIFICATIONS

**OPERATION:** Charge/Close/Trip

**WEIGHT:** 28.0 lbs.

**DIMENSIONS:**\* 17.9" x 17.0" x 8.5"

**COMPATIBLE WITH:** Type SB, SBA, SBS (includes all; Trip Button Lower Right, Close Button Upper Left)

**CONTROL/POWER SOURCE:**  
RSO-IAR-M18

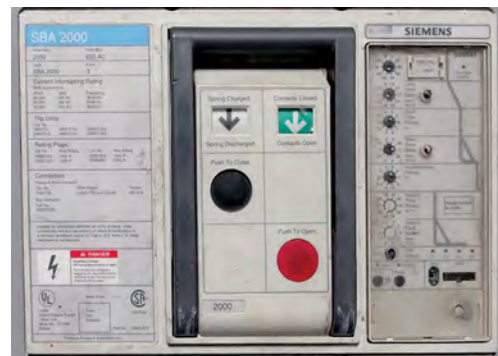

# RSA-16A

FOR USE WITH:

**Siemens**  
**Insulated Case Circuit Breaker**

## SPECIFICATIONS

**OPERATION:** Close/Trip

**WEIGHT:** 13.1 lbs.

**DIMENSIONS:**\* 19.2" x 7.8" x 6.5"

**COMPATIBLE WITH:** Type SB, SBA, SBS (includes all; Trip Button Lower Right, Close Button Upper Left)

**CONTROL/POWER SOURCE:**  
RSO-IAR-M18

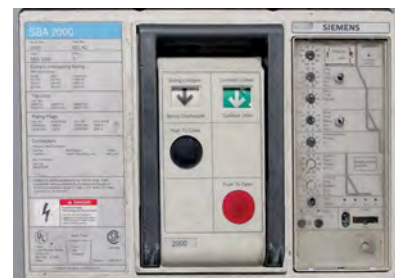

\*All unit measurements are L x W x H

# RSA-16B

FOR USE WITH:

**Siemens  
Insulated Case Circuit Breaker**

## SPECIFICATIONS

**OPERATION:** Charge/Close/Trip

**WEIGHT:** 28.0 lbs.

**DIMENSIONS:\*** 17.9" x 17.0" x 8.5"

**COMPATIBLE WITH:** Type SB, SBA, SBS (includes all; Trip Button Lower Right, Close Button Lower Left)

**CONTROL/POWER SOURCE:**  
RSO-IAR-M18



# RSA-17

FOR USE WITH:

**Allis-Chalmers/Siemens-Allis/Siemens  
Air Circuit Breaker**

## SPECIFICATIONS

**OPERATION:** Trip Only

**WEIGHT:** 10.2 lbs.

**DIMENSIONS:\*** 15.0" x 10.2" x 10.5"

**COMPATIBLE WITH:** Type FA, FB, FC - All

**CONTROL/POWER SOURCE:**  
RSO-IAR-M18



# RSA-18

FOR USE WITH:

**General Electric  
Air Circuit Breaker**

## SPECIFICATIONS

**OPERATION:** Charge/Close/Trip

**WEIGHT:** 22.7 lbs.

**DIMENSIONS:\*** 18.2" x 11.4" x 7.0"

**COMPATIBLE WITH:** Type AK-1, 2, 3(A)-50, 75, 100 (Manually Operated)

**CONTROL/POWER SOURCE:**  
RSO-IIID-M18

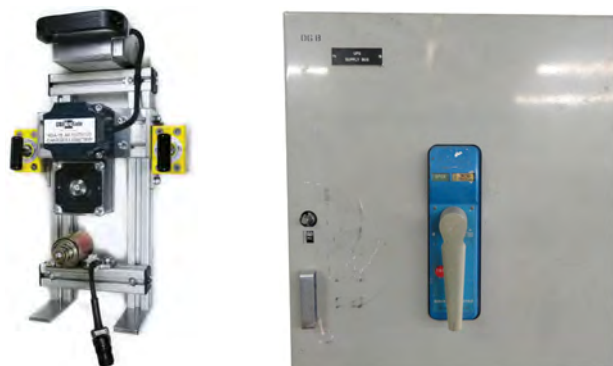

\*All unit measurements are L x W x H

# RSA-18A

FOR USE WITH:  
**General Electric  
Air Circuit Breaker**

## SPECIFICATIONS

OPERATION: Close/Trip

WEIGHT: 14.0 lbs.

DIMENSIONS:\* 15.8" x 7.4" x 6.0"

COMPATIBLE WITH: Type  
AK-1/2/3(A)-50/75/100 (Manually  
Operated)

CONTROL/POWER SOURCE:  
RSO-IIID-M18



# RSA-18B

FOR USE WITH:  
**General Electric  
Air Circuit Breaker**

## SPECIFICATIONS

OPERATION: Close/Trip

WEIGHT: 22.0 lbs.

DIMENSIONS:\* 18.4" x 6.0" x 10.8"

COMPATIBLE WITH: Type  
AK-1/2/3(A)-50/75/100 (Manually  
Operated)

CONTROL/POWER SOURCE:  
RSO-IIID-M18



# RSA-20

FOR USE WITH:  
**Westinghouse/Cutler-Hammer  
Molded Case Circuit Breaker**

## SPECIFICATIONS

OPERATION: Close/Trip

WEIGHT: 10.0 lbs.

DIMENSIONS:\* 10.5" x 4.5" x 8.4"

COMPATIBLE WITH: Molded Case Circuit  
Breaker (MCCB) Black Molded Case Only -  
E Frame (includes EA, EB, EC, ED, EG, EH)  
& F Frame (includes FA, FB, FC, FD, FG, FH)  
- 10-150 A

CONTROL/POWER SOURCE: RSO-IAR-M18



\*All unit measurements are L x W x H

# RSA-20A

FOR USE WITH:

**Westinghouse/Cutler-Hammer  
Molded Case Circuit Breaker**

## SPECIFICATIONS

**OPERATION:** Close/Trip

**WEIGHT:** 8.0 lbs.

**DIMENSIONS:**\* 7.6" x 5.8" x 6.4"

**COMPATIBLE WITH:** Molded Case Circuit Breaker (MCCB) Black Molded Case Only - JB Frame (90-250 A), KB Frame (90-250 A), & HKB Frame (90-250 A)

**CONTROL/POWER SOURCE:**  
RSO-IAR-M18



# RSA-20B

FOR USE WITH:

**Westinghouse/Cutler-Hammer  
Molded Case Circuit Breaker**

## SPECIFICATIONS

**OPERATION:** Close/Trip

**WEIGHT:** 10.0 lbs.

**DIMENSIONS:**\* 8.4" x 4.4" x 10.7"

**COMPATIBLE WITH:** Molded Case Circuit Breaker (MCCB) Black Molded Case Only - JA Frame (70-225 A), KA Frame (70-225 A), & HKA Frame (70-225 A)

**CONTROL/POWER SOURCE:**  
RSO-IAR-M18



# RSA-20C

FOR USE WITH:

**Westinghouse/Cutler-Hammer  
Molded Case Circuit Breaker**

## SPECIFICATIONS

**OPERATION:** Close/Trip

**WEIGHT:** 16.0 lbs.

**DIMENSIONS:**\* 14.3" x 8.7" x 7.7"

**COMPATIBLE WITH:** Molded Case Circuit Breaker (MCCB) Black Molded Case Only - LA Frame (70-400 A), LAB Frame (125-400 A), HLA Frame (70-400 A), LC Frame

**CONTROL/POWER SOURCE:**  
RSO-IAR-M18



\*All unit measurements are L x W x H

# RSA-20CR

FOR USE WITH:

**Westinghouse/Cutler-Hammer  
Molded Case Circuit Breaker**

## SPECIFICATIONS

OPERATION: Close/Trip

WEIGHT: 16.1 lbs.

DIMENSIONS:\* 17.6" x 8.1" x 7.6"

COMPATIBLE WITH: L Frame (includes LA, LB, LC, LD) - 125-600 A (Recessed Mount)

CONTROL/POWER SOURCE: RSO-IAR-M18



# RSA-20D

FOR USE WITH:

**Westinghouse/Cutler-Hammer  
Molded Case Circuit Breaker**

## SPECIFICATIONS

OPERATION: Close/Trip

WEIGHT: 15.0 lbs.

DIMENSIONS:\* 21.1" x 6.7" x 4.5"

COMPATIBLE WITH: Molded Case Circuit Breaker (MCCB) Black Molded Case Only - MA Frame (125-800 A), HMA Frame (125-800 A), MC

CONTROL/POWER SOURCE: RSO-IAR-M18



# RSA-20E

FOR USE WITH:

**Westinghouse/Cutler-Hammer  
Molded Case Circuit Breaker**

## SPECIFICATIONS

OPERATION: Close/Trip

WEIGHT: 16.0 lbs.

DIMENSIONS:\* 14.6" x 8.7" x 7.4"

COMPATIBLE WITH: Molded Case Circuit Breaker (MCCB) Black Molded Case Only - NB Frame (700-1200 A), HNB Frame (700-1200 A), NC

CONTROL/POWER SOURCE: RSO-IAR-M18



\*All unit measurements are L x W x H

# RSA-20F

FOR USE WITH:

**Westinghouse/Cutler-Hammer  
Molded Case Circuit Breaker**

## SPECIFICATIONS

**OPERATION:** Close/Trip

**WEIGHT:** 25.0 lbs.

**DIMENSIONS:**\* 29.0" x 9.7" x 6.0"

**COMPATIBLE WITH:** Molded Case Circuit Breaker (MCCB) Black Molded Case Only - PB Frame (2000-3000 A), PA, PC

**CONTROL/POWER SOURCE:**  
RSO-IAR-M18



# RSA-21

FOR USE WITH:

**Square D  
Load Break Switch**

## SPECIFICATIONS

**OPERATION:** Close/Trip

**WEIGHT:** 14.2 lbs.

**DIMENSIONS:**\* 20.0" x 8.4" x 5.0"

**COMPATIBLE WITH:** Mini Break (Class 9875, includes HVMB305200, HVMB305200U, HVMO-305025, HVMO-305200, HVMO305000U), Mini-Flex (Class 8196 AC Controller)

**CONTROL/POWER SOURCE:**  
RSO-IAR-M18

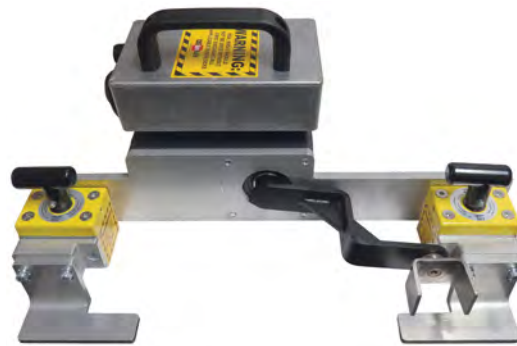

# RSA-22

FOR USE WITH:

**General Electric  
Load Break Switch**

## SPECIFICATIONS

**OPERATION:** Close/Trip

**WEIGHT:** 20.5 lbs.

**DIMENSIONS:**\* 7.0" x 8.5" x 22.0"

**COMPATIBLE WITH:** IC1074 Series (includes IC1074, IC1074A, IC1074B)

**CONTROL/POWER SOURCE:**  
RSO-IAR-M18



\*All unit measurements are L x W x H

# RSA-23

FOR USE WITH:  
**Westinghouse  
Air Circuit Breaker**

## SPECIFICATIONS

**OPERATION:** Trip Only  
**WEIGHT:** 6.6 lbs.  
**DIMENSIONS:**\* 6.8" x 5.1" x 6.5"  
**COMPATIBLE WITH:** Type 50DH-150, 250, 350  
**CONTROL/POWER SOURCE:** RSO-IAR-M18



# RSA-27

FOR USE WITH:  
**Square D  
Load Interrupter Switch**

## SPECIFICATIONS

**OPERATION:** Close/Trip  
**WEIGHT:** 21.0 lbs.  
**DIMENSIONS:**\* 7.5" x 13.3" x 21.0"  
**COMPATIBLE WITH:** HVL/CC Medium-Voltage Metal-Enclosed Switchgear, Load Interrupter Switch with Over Toggle Mechanism  
**CONTROL/POWER SOURCE:** RSO-IAR-M18



# RSA-27A

FOR USE WITH:  
**Square D  
Load Interrupter Switch**

## SPECIFICATIONS

**OPERATION:** Charge/Close/Trip  
**WEIGHT:** 24.4 lbs.  
**DIMENSIONS:**\* 21.1" x 15.5" x 7.7"  
**COMPATIBLE WITH:** HVL/CC Medium-Voltage Metal-Enclosed Switchgear, Load Interrupter Switch with Stored Energy Mechanism  
**CONTROL/POWER SOURCE:** RSO-IIID-M18



\*All unit measurements are L x W x H

# RSA-27B

FOR USE WITH:

**Schneider Electric/Square D  
Load Break Switch**

## SPECIFICATIONS

**OPERATION:** Close/Trip

**WEIGHT:** 13.4 lbs.

**DIMENSIONS:**\* 21.1" x 7.2" x 6.0"

**COMPATIBLE WITH:** HVL/CC Medium-Voltage Metal-Enclosed Switchgear, Load Interrupter Switch with Stored Energy Mechanism

**CONTROL/POWER SOURCE:**  
RSO-IIID-M18



# RSA-29

FOR USE WITH:

**General Electric  
Air Circuit Breaker**



## SPECIFICATIONS

**OPERATION:** Charge/Close/Trip

**WEIGHT:** 11.0 lbs.

**DIMENSIONS:**\* 10.7" x 8.6" x 9.2"

**COMPATIBLE WITH:** Type AK-1, 2, 3-25 (Manually Operated with Trip Button Below Handle)

**CONTROL/POWER SOURCE:**  
RSO-IIID-M18



# RSA-29A

FOR USE WITH:

**General Electric  
Air Circuit Breaker**

## SPECIFICATIONS

**OPERATION:** Charge/Close/Trip

**WEIGHT:** 11.7 lbs.

**DIMENSIONS:**\* 10.7" x 9.6" x 10.7"

**COMPATIBLE WITH:** Type AKR-6, 7, 8, 9, 10D-30S

**CONTROL/POWER SOURCE:**  
RSO-IIID-M18



\*All unit measurements are L x W x H

# RSA-29B

FOR USE WITH:  
**General Electric  
Air Circuit Breaker**

## SPECIFICATIONS

OPERATION: Close/Trip

WEIGHT: 4.8 lbs.

DIMENSIONS:\* 9.0" x 5.4" x 5.1"

COMPATIBLE WITH: Type AK-1, 2,  
3-25 Close, Trip (Electrically Operated,  
Trip and Close Buttons)

CONTROL/POWER SOURCE:  
RSO-IAR-M18



# RSA-30

FOR USE WITH:  
**ABB/BBC/ITE  
Air Circuit Breaker**

## SPECIFICATIONS

OPERATION: Charge/Close/Trip

WEIGHT: 26.3 lbs.

DIMENSIONS:\* 11.7" x 16.0" x 9.2"

COMPATIBLE WITH: Type K-Line  
(2000 A & Below)

CONTROL/POWER SOURCE:  
RSO-IIID-M18



# RSA-30A

FOR USE WITH:  
**ABB/BBC/ITE  
Air Circuit Breaker**

## SPECIFICATIONS

OPERATION: Charge/Close/Trip

WEIGHT: 35.5 lbs.

DIMENSIONS:\* 21.9" x 14.9" x 11.7"

COMPATIBLE WITH: Type K-Line  
(3000 A & Above)

CONTROL/POWER SOURCE:  
RSO-IIID-M18



\*All unit measurements are L x W x H

# RSA-30B

FOR USE WITH:  
**ABB/BBC/ITE**  
**Air Circuit Breaker**

## SPECIFICATIONS

**OPERATION:** Close/Trip

**WEIGHT:** 14.2 lbs.

**DIMENSIONS:**\* 9.8" x 14.0" x 7.3"

**COMPATIBLE WITH:** Type K-Line/K Don 2000 A and Below for Electrically Operated Breakers (Close/Trip)

**CONTROL/POWER SOURCE:**  
RSO-IIID-M18



# RSA-30C

FOR USE WITH:  
**ABB/BBC/ITE**  
**Air Circuit Breaker**

## SPECIFICATIONS

**OPERATION:** Close/Trip

**WEIGHT:** 17.0 lbs.

**DIMENSIONS:**\* 18.5" x 14.3" x 6.0"

**COMPATIBLE WITH:** Type K-Line/K Don 3000-4000 A (Close/Trip)

**CONTROL/POWER SOURCE:**  
RSO-IIID-M18



# RSA-31

FOR USE WITH:  
**Powercon**  
**Load Break Switch**

## SPECIFICATIONS

**OPERATION:** Close/Trip

**WEIGHT:** 24.5 lbs.

**DIMENSIONS:**\* 6.3" x 9.5" x 30.0"

**COMPATIBLE WITH:** Load Break Interrupter Switch (PIF Interrupter 600 A & 1200 A), Flush

**CONTROL/POWER SOURCE:**  
RSO-IAR-M18



\*All unit measurements are L x W x H

# RSA-31A

FOR USE WITH:

**Powercon  
Load Break Switch**

## SPECIFICATIONS

OPERATION: Close/Trip

WEIGHT: 27.5 lbs.

DIMENSIONS:\* 5.5" x 9.2" x 27.1"

COMPATIBLE WITH: Load Break Interrupter Switch (PIF Interrupter 600 A & 1200 A), Recessed

CONTROL/POWER SOURCE:  
RSO-IAR-M18



# RSA-32

FOR USE WITH:

**Mitsubishi  
Motor Control Center**

## SPECIFICATIONS

OPERATION: Close/Trip

WEIGHT: 23.5 lbs.

DIMENSIONS:\* 15.1" x 9.3" x 8.8"

COMPATIBLE WITH: Medium-Voltage MCC Handle

CONTROL/POWER SOURCE:  
RSO-IIID-M18



# RSA-33

FOR USE WITH:

**Square D  
Motor Control Center**

## SPECIFICATIONS

OPERATION: Close/Trip

WEIGHT: 7.1 lbs.

DIMENSIONS:\* 8.4" x 5.9" x 4.4"

COMPATIBLE WITH: Model 6 MCC: Size 1-5 Bucket & Main (Red & Green Handle Operator, Original Vintage, Handle Base Length 5.69")

CONTROL/POWER SOURCE:  
RSO-IAR-M18



\*All unit measurements are L x W x H

# RSA-33A

FOR USE WITH:

**Square D  
Motor Control Center**

## SPECIFICATIONS

**OPERATION:** Close/Trip

**WEIGHT:** 7.0 lbs.

**DIMENSIONS:**\* 8.4" x 5.9" x 4.4"

**COMPATIBLE WITH:** Model 6 MCC: Size 1-5 Bucket & Main (Red & Green Handle Operator, Current Vintage, Handle Base Length 4.75")

**CONTROL/POWER SOURCE:**  
RSO-IAR-M18

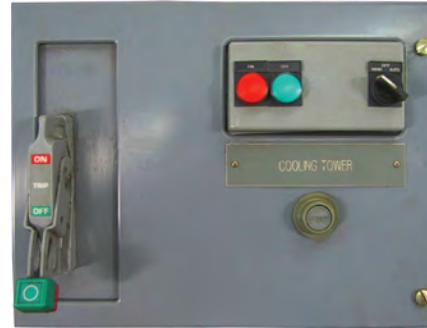

# RSA-34

FOR USE WITH:

**General Electric  
Motor Control Center**

## SPECIFICATIONS

**OPERATION:** Close/Trip

**WEIGHT:** 16.0 lbs.

**DIMENSIONS:**\* 13.4" x 8.1" x 7.3"

**COMPATIBLE WITH:** TDM Door Mounted Handle Operating Mechanism, SKOM2 Operating Mechanism, 7098 Motor Control Center (MCC) Size 1-4 Bucket

**CONTROL/POWER SOURCE:**  
RSO-IAR-M18

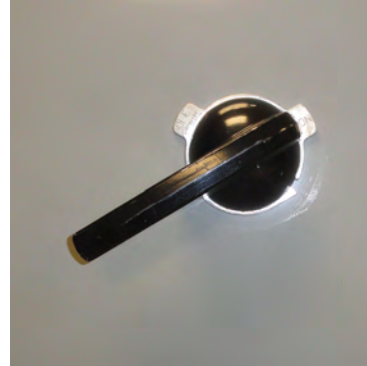
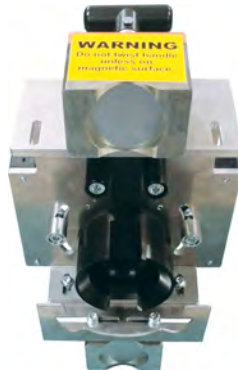

# RSA-34B

FOR USE WITH:

**General Electric  
Motor Control Center**

## SPECIFICATIONS

**OPERATION:** Close/Trip

**WEIGHT:** 8.7 lbs.

**DIMENSIONS:**\* 7.8" x 4.3" x 5.8"

**COMPATIBLE WITH:** TDM Door Mounted Handle Operating Mechanism & 7098 Motor Control Center (MCC) Size 1-4 Bucket (Short Handle)

**CONTROL/POWER SOURCE:**  
RSO-IAR-M18



\*All unit measurements are L x W x H

# RSA-35

FOR USE WITH:

**Westinghouse/Eaton/Cutler-Hammer  
Motor Control Center**

## SPECIFICATIONS

OPERATION: Close/Trip

WEIGHT: 12.0 lbs.

DIMENSIONS:\* 6.5" x 5.5" x 11.0"

COMPATIBLE WITH: Westinghouse 11-300 MCC Bucket (Size 1-4 only), Eaton, Cutler-Hammer Molded Case Circuit Breaker (MCCB) Slide Plate Type Handle Mechanism (314C386G02, 314C386G03, 314C386G05, 314C386G06, 314C386G09, 314C386G10)

CONTROL/POWER SOURCE: RSO-IAR-M18



# RSA-35B

FOR USE WITH:

**Westinghouse/Eaton/Cutler-Hammer  
Motor Control Center**

## SPECIFICATIONS

OPERATION: Close/Trip

WEIGHT: 23.2 lbs.

DIMENSIONS:\* 15.6" x 9.0" x 9.3"

COMPATIBLE WITH: Westinghouse 11-300 MCC Bucket (Size 5 only), Eaton, Cutler-Hammer Molded Case Circuit Breaker (MCCB) Slide Plate Type Handle Mechanism (314C386G01, 314C386G04, 314C386G08)

CONTROL/POWER SOURCE: RSO-IAR-M18



# RSA-36A

FOR USE WITH:

**Cutler-Hammer  
Motor Control Center**

## SPECIFICATIONS

OPERATION: Close/Trip

WEIGHT: 6.5 lbs.

DIMENSIONS:\* 13.2" x 4.4" x 5.1"

COMPATIBLE WITH: Freedom Unitrol

CONTROL/POWER SOURCE: RSO-IAR-M18



\*All unit measurements are L x W x H

# RSA-37

FOR USE WITH:  
**Siemens-Allis/Siemens  
Motor Control Center**

## SPECIFICATIONS

**OPERATION:** Close/Trip

**WEIGHT:** 7.8 lbs.

**DIMENSIONS:**\* 13.9" x 6.3" x 5.9"

**COMPATIBLE WITH:** Type MarQ21,  
Model 90 MCC Bucket - Size 1-4 (Black  
Plastic Handle Operator with White  
Lettering)

**CONTROL/POWER SOURCE:**  
RSO-IAR-M18



# RSA-39

FOR USE WITH:  
**General Electric  
Motor Control Center**

## SPECIFICATIONS

**OPERATION:** Close/Trip

**WEIGHT:** 10.7 lbs.

**DIMENSIONS:**\* 13.5 x 8.6 x 6.7"

**COMPATIBLE WITH:** Type E9000  
Evolution MCC - Bucket Size 1-4  
Standard & Size 1 Horizontal

**CONTROL/POWER SOURCE:**  
RSO-IAR-M18



# RSA-39B

FOR USE WITH:  
**General Electric  
Motor Control Center**

## SPECIFICATIONS

**OPERATION:** Close/Trip

**WEIGHT:** 14.0 lbs.

**DIMENSIONS:**\* 10.7" x 15.5" x 19.5"

**COMPATIBLE WITH:** Type E9000  
Evolution MCC - Main

**CONTROL/POWER SOURCE:**  
RSO-IAR-M18



\*All unit measurements are L x W x H

# RSA-40

FOR USE WITH:  
**Eaton/Cutler-Hammer  
Handle Operator**

## SPECIFICATIONS

**OPERATION:** Close/Trip

**WEIGHT:** 12.4 lbs.

**DIMENSIONS:**\* 12.1" x 5.6" x 6.8"

**COMPATIBLE WITH:** Vari-Depth Type Handle Mechanism; NEMA Type 1, 3R, 12 (Handle Style Number: 504C323G07)

**CONTROL/POWER SOURCE:**  
RSO-IAR-M18

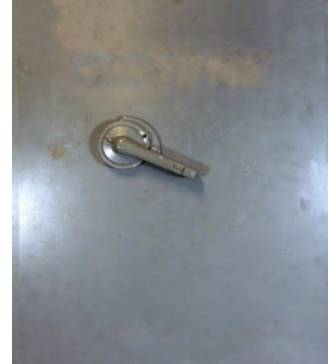

# RSA-41

FOR USE WITH:  
**Allen-Bradley  
Motor Control Center**

## SPECIFICATIONS

**OPERATION:** Close/Trip

**WEIGHT:** 6.4 lbs.

**DIMENSIONS:**\* 13.5" x 3.8" x 4.4"

**COMPATIBLE WITH:** Centerline 2100 Motor Control Center (MCC) - Size 1-4 Bucket (Black or Gray Plastic Handle) (LVMCC)

**CONTROL/POWER SOURCE:**  
RSO-IAR-M18



# RSA-41A

FOR USE WITH:  
**Allen-Bradley  
Motor Control Center**

## SPECIFICATIONS

**OPERATION:** Close/Trip

**WEIGHT:** 10.6 lbs.

**DIMENSIONS:**\* 20.0" x 5.9" x 4.5"

**COMPATIBLE WITH:** Centerline 2100 Motor Control Center (MCC) - Size 5 Bucket (Black or Gray Plastic Handle) (LVMCC)

**CONTROL/POWER SOURCE:**  
RSO-IAR-M18



\*All unit measurements are L x W x H

# RSA-41B

FOR USE WITH:  
**Allen-Bradley  
Motor Control Center**

## SPECIFICATIONS

**OPERATION:** Close/Trip

**WEIGHT:** 13.5 lbs.

**DIMENSIONS:**\* 12.5" x 7.1" x 5.6"

**COMPATIBLE WITH:** Centerline 2100 Motor Control Center (MCC) - Main (Black or Gray Plastic Handle) (LVMCC)

**CONTROL/POWER SOURCE:**  
RSO-IAR-M18

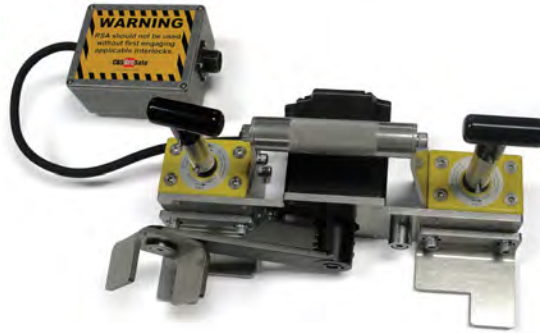

# RSA-41C

FOR USE WITH:  
**Allen-Bradley  
Motor Control Center**

## SPECIFICATIONS

**OPERATION:** Close/Trip

**WEIGHT:** 7.3 lbs.

**DIMENSIONS:**\* 7.9" x 5.7" x 4.6"

**COMPATIBLE WITH:** Centerline 2100 Motor Control Center (MCC) - Size 1 Horizontal Bucket (Black or Gray Plastic Handle) (LVMCC)

**CONTROL/POWER SOURCE:**  
RSO-IAR-M18



# RSA-42

FOR USE WITH:  
**Eaton/Cutler-Hammer  
Handle Operator**

## SPECIFICATIONS

**OPERATION:** Close/Trip

**WEIGHT:** 15.3 lbs.

**DIMENSIONS:**\* 12.0" x 8.0" x 8.2"

**COMPATIBLE WITH:** Series C Rotary Through-The-Door Handle Mechanism (for Use with Molded Case Circuit Breakers G, F, J, K, L, MDL Frames, Molded Case Switches, and Motor Circuit Protectors)

**CONTROL/POWER SOURCE:** RSO-IAR-M18



\*All unit measurements are L x W x H

# RSA-43

FOR USE WITH:  
**General Electric  
Load Break Switch**

## SPECIFICATIONS

OPERATION: Close/Trip

WEIGHT: 22.7 lbs.

DIMENSIONS:\* 10.2" x 10.1" x 6.9"

COMPATIBLE WITH: SE-100  
Series Load Break Switch 600-  
1200 A, 5 kV, 15 kV

CONTROL/POWER SOURCE:  
RSO-IAR-M18



# RSA-44

FOR USE WITH:  
**Square D  
Motor Control Center**

## SPECIFICATIONS

OPERATION: Close/Trip

WEIGHT: 16.2 lbs.

DIMENSIONS:\* 15.5" x 9.1" x 6.4"

COMPATIBLE WITH: Iso-Flex  
Model 4 Class 8198 Medium-  
Voltage Controller

CONTROL/POWER SOURCE:  
RSO-IAR-M18

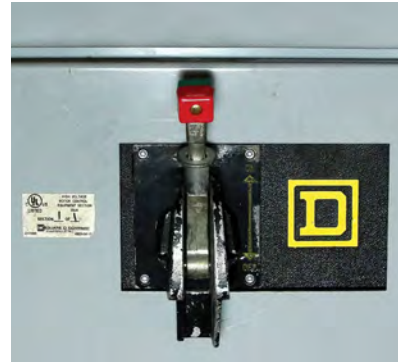

# RSA-45

FOR USE WITH:  
**General Electric  
Air Circuit Breaker**

## SPECIFICATIONS

OPERATION: Charge/Close/Trip

WEIGHT: 28.9 lbs.

DIMENSIONS:\* 17.5" x 13.7" x 7.8"

COMPATIBLE WITH: Type AKR-4,  
5-A-30, 50

CONTROL/POWER SOURCE:  
RSO-IIID-M18

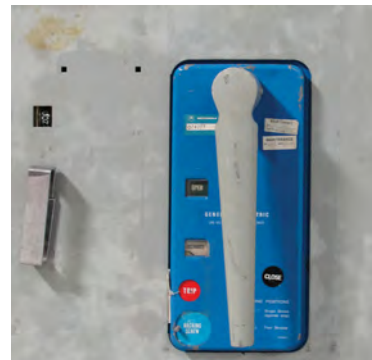

\*All unit measurements are L x W x H

# RSA-45A

FOR USE WITH:

**General Electric  
Air Circuit Breaker**

## SPECIFICATIONS

**OPERATION:** Charge/Close/Trip

**WEIGHT:** 26.0 lbs.

**DIMENSIONS:**\* 17.5" x 15.0" x 11.3"

**COMPATIBLE WITH:** Type AKR-6,  
10D-30, 50

**CONTROL/POWER SOURCE:**  
RSO-IIID-M18



# RSA-45B

FOR USE WITH:

**General Electric  
Air Circuit Breaker**

## SPECIFICATIONS

**OPERATION:** Close/Trip

**WEIGHT:** 7.3 lbs.

**DIMENSIONS:**\* 14.5" x 14.8" x 6.9"

**COMPATIBLE WITH:** Type AKR-6,  
10D-75, 100

**CONTROL/POWER SOURCE:**  
RSO-IIID-M18

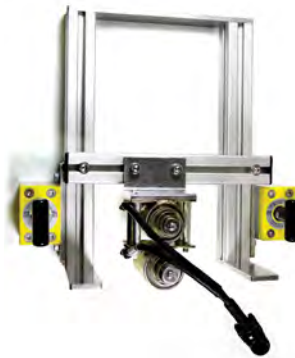

# RSA-45C

FOR USE WITH:

**General Electric  
Air Circuit Breaker**

## SPECIFICATIONS

**OPERATION:** Charge/Close/Trip

**WEIGHT:** 28.0 lbs.

**DIMENSIONS:**\* 17.5" x 14.8" x 9.3"

**COMPATIBLE WITH:** Type AKR-6,  
10D-75, 100

**CONTROL/POWER SOURCE:**  
RSO-IIID-M18



\*All unit measurements are L x W x H

# RSA-45D

FOR USE WITH:

**General Electric  
Air Circuit Breaker**

## SPECIFICATIONS

OPERATION: Close/Trip

WEIGHT: 15.5 lbs.

DIMENSIONS:\* 13.8" x 14.8" x 7.5"

COMPATIBLE WITH: Type AKR-6,  
10D-30, 50-CT

CONTROL/POWER SOURCE:  
RSO-IIID-M18



# RSA-45E

FOR USE WITH:

**General Electric  
Air Circuit Breaker**

## SPECIFICATIONS

OPERATION: Close/Trip

WEIGHT: 15.5 lbs.

DIMENSIONS:\* 13.8" x 14.8" x 7.5"

COMPATIBLE WITH: Type AKR-4,  
5-A-30, 50

CONTROL/POWER SOURCE:  
RSO-IAR-M18



# RSA-46

FOR USE WITH:

**General Electric  
Motor Control Center**

## SPECIFICATIONS

OPERATION: Close/Trip

WEIGHT: 11.0 lbs.

DIMENSIONS:\* 10.7" x 9.5" x 4.4"

COMPATIBLE WITH: Type 8000  
Motor Control Center (MCC) Size  
1-4 (Small Escutcheon Around  
Handle Operator)

CONTROL/POWER SOURCE:  
RSO-IAR-M18

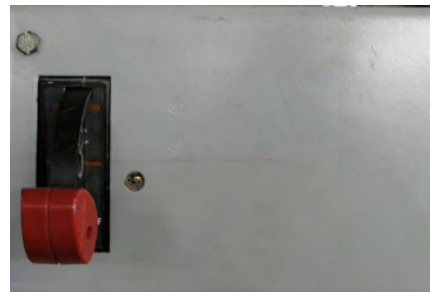

\*All unit measurements are L x W x H

# RSA-46A

FOR USE WITH:

**General Electric  
Motor Control Center**

## SPECIFICATIONS

**OPERATION:** Close/Trip

**WEIGHT:** 11.4 lbs.

**DIMENSIONS:**\* 10.7" x 10.8" x 4.4"

**COMPATIBLE WITH:** Type 8000 Motor Control Center (MCC) Size 1-4 (Large Escutcheon Around Handle Operator)

**CONTROL/POWER SOURCE:**  
RSO-IAR-M18



# RSA-46B

FOR USE WITH:

**General Electric  
Motor Control Center**

## SPECIFICATIONS

**OPERATION:** Close/Trip

**WEIGHT:** 13.5 lbs.

**DIMENSIONS:**\* 13.5" x 6.3" x 5.6"

**COMPATIBLE WITH:** Type 8000 Motor Control Center (MCC) Size 5 Bucket, Type 8000 Style Main Disconnect (Up to 800 A)

**CONTROL/POWER SOURCE:**  
RSO-IAR-M18



# RSA-46D

FOR USE WITH:

**General Electric  
Motor Control Center**

## SPECIFICATIONS

**OPERATION:** Close/Trip

**WEIGHT:** 19.2 lbs.

**DIMENSIONS:**\* 20.5" x 11.9" x 6.0"

**COMPATIBLE WITH:** Type 8000 Motor Control Center (MCC) Main Disconnect (800-1200 A)

**CONTROL/POWER SOURCE:**  
RSO-IAR-M18



\*All unit measurements are L x W x H

# RSA-47

FOR USE WITH:  
**Allen-Bradley  
Motor Control Center**

## SPECIFICATIONS

**OPERATION:** Close/Trip

**WEIGHT:** 8.2 lbs.

**DIMENSIONS:**\* 12.4" x 9.9" x 4.4"

**COMPATIBLE WITH:** Centerline 2100 (Legacy) Motor Control Center (MCC) Size 1-4 Bucket (Metal Handle, Flush Mounted, 7" Base Length) (LVMCC)

**CONTROL/POWER SOURCE:**  
RSO-IAR-M18



# RSA-47A

FOR USE WITH:  
**Allen-Bradley  
Motor Control Center**

## SPECIFICATIONS

**OPERATION:** Close/Trip

**WEIGHT:** 14.0 lbs.

**DIMENSIONS:**\* 13.0" x 7.2" x 7.2"

**COMPATIBLE WITH:** Centerline 2100 (Legacy) Motor Control Center (MCC) Size 5 Bucket and Centerline 5 kV Starter (Metal Handle, Flush Mounted, 9" Base Length)

**CONTROL/POWER SOURCE:**  
RSO-IAR-M18



# RSA-47B

FOR USE WITH:  
**Allen-Bradley  
Motor Control Center**

## SPECIFICATIONS

**OPERATION:** Close/Trip

**WEIGHT:** 14.1 lbs.

**DIMENSIONS:**\* 13.0 x 6.2 x 9.3"

**COMPATIBLE WITH:** Centerline 2100 (Legacy) Motor Control Center (MCC) Size 1-4 Bucket (Metal Handle, Recessed Mounted, 7" Base Length) (LVMCC)

**CONTROL/POWER SOURCE:**  
RSO-IAR-M18



\*All unit measurements are L x W x H

# RSA-48

FOR USE WITH:  
**Eaton/Cutler-Hammer  
Insulated Case Circuit Breaker**



## SPECIFICATIONS

**OPERATION:** Charge/Close/Trip

**WEIGHT:** 23.3 lbs.

**DIMENSIONS:**\* 17.0" x 17.8" x 8.2"

**COMPATIBLE WITH:** Magnum DS, SB, MW (Door Closed, 800-4000 A), MDS, MSB, MWI, MWN

**CONTROL/POWER SOURCE:** RSO-IIID-M18



# RSA-48C

FOR USE WITH:  
**Eaton/Cutler-Hammer  
Insulated Case Circuit Breaker**

## SPECIFICATIONS

**OPERATION:** Charge/Close/Trip

**WEIGHT:** 12.3 lbs.

**DIMENSIONS:**\* 10.0" x 17.3" x 5.5"

**COMPATIBLE WITH:** Magnum DS, SB, MW (Door Closed, 800-4000 A), MDS, MSB, MWI, MWN

**CONTROL/POWER SOURCE:** RSO-IIID-M18



# RSA-50

FOR USE WITH:  
**Schneider Electric  
Motor Control Center**

## SPECIFICATIONS

**OPERATION:** Close/Trip

**WEIGHT:** 20.1 lbs.

**DIMENSIONS:**\* 21.6" x 10.4" x 9.1"

**COMPATIBLE WITH:** Motorpact Medium-Voltage Motor Starter (Isolation Switch Operation Only)

**CONTROL/POWER SOURCE:** RSO-IAR-M18

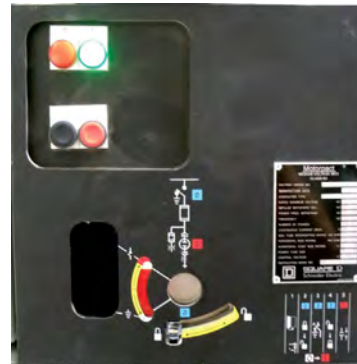

\*All unit measurements are L x W x H

# RSA-50A

FOR USE WITH:

**Schneider Electric  
Motor Control Center**

## SPECIFICATIONS

OPERATION: Close/Trip

WEIGHT: 14.6 lbs.

DIMENSIONS:\* 21.6 x 12.3 x 8.0"

COMPATIBLE WITH: Motorpact  
Medium-Voltage Motor Starter (Close/  
Trip)

CONTROL/POWER SOURCE:  
RSO-IAR-M18

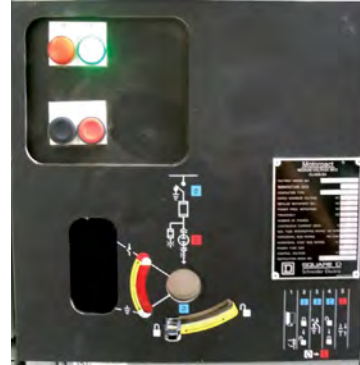

# RSA-51

FOR USE WITH:

**Siemens/Siemens-Allis  
Air Circuit Breaker**

## SPECIFICATIONS

OPERATION: Charge/Close/Trip

WEIGHT: 36.5 lbs.

DIMENSIONS:\* 19.3" x 14.5" x 8.2"

COMPATIBLE WITH: Type RL, RLE, RLF,  
RLI, 800-2000 A (Gray, Black, or Yellow  
Zinc Face, Manually Operated, includes  
RL, RLE, RLF, RLI-800, 1600, 2000)

CONTROL/POWER SOURCE: RSO-IIID



# RSA-51A

FOR USE WITH:

**Siemens/Siemens-Allis  
Air Circuit Breaker**

## SPECIFICATIONS

OPERATION: Close/Trip

WEIGHT: 14.6 lbs.

DIMENSIONS:\* 20.0" x 7.5" x 7.4"

COMPATIBLE WITH: Type RL, RLE, RLF,  
3200-5000 A (Gray, Black, or Yellow Zinc  
Face, Manually Operated, includes RL, RLE,  
RLF-3200, 4000, 5000)

CONTROL/POWER SOURCE: RSO-IIID-M18



\*All unit measurements are L x W x H

# RSA-51C

FOR USE WITH:

**Siemens/Siemens-Allis  
Air Circuit Breaker**  
*(Charge Assembly)*

## SPECIFICATIONS

**OPERATION:** Charge/Close/Trip

**WEIGHT:** 32.9 lbs.

**DIMENSIONS:\*** 19.0" x 13.6" x 14.7"

**COMPATIBLE WITH:** Type RL, RLE, RLF, 3200-5000 A (Gray, Black, or Yellow Zinc Face, Manually Operated, includes RL, RLE, RLF-3200, 4000, 5000) Charge Assembly

**CONTROL/POWER SOURCE:**  
RSO-IIID-M18



# RSA-51C

FOR USE WITH:

**Siemens/Siemens-Allis  
Air Circuit Breaker**  
*(Close/Trip Assembly)*

## SPECIFICATIONS

**OPERATION:** Close/Trip

**WEIGHT:** 17.4 lbs.

**DIMENSIONS:\*** 19.7" x 16.4" x 7.2"

**COMPATIBLE WITH:** Type RL, RLE, RLF, 3200-4000 A (Gray, Black, or Yellow Zinc Face, Manually Operated, includes RL, RLE, RLF-3200, 4000, 5000)

**CONTROL/POWER SOURCE:**  
RSO-IIID-M18



# RSA-52

FOR USE WITH:

**Siemens  
Handle Operator**

## SPECIFICATIONS

**OPERATION:** Close/Trip

**WEIGHT:** 15.4 lbs.

**DIMENSIONS:\*** 13.1" x 6.5" x 8.3"

**COMPATIBLE WITH:** RHOH Rotary Door Mounted Operating Handle (for MD, ND, PD, & RD Frame Molded Case Circuit Breakers (MCCBs), NEMA Type 1, 3, 3R, 12, 4, & 4X Enclosures)

**CONTROL/POWER SOURCE:**  
RSO-IAR-M18

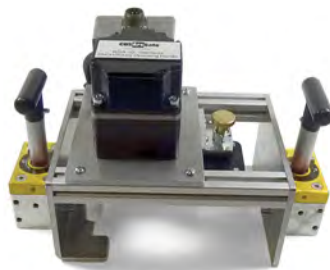

\*All unit measurements are L x W x H

# RSA-52A

FOR USE WITH:  
**Siemens  
Handle Operator**

## SPECIFICATIONS

OPERATION: Close/Trip

WEIGHT: 13.8 lbs.

DIMENSIONS:\* 8.8" x 8.5" x 8.8"

COMPATIBLE WITH: CRHOH Rotary Door Mounted Operating Handle (for ED, FD, JD, LD, & LMD Frame Molded Case Circuit Breakers (MCCBs), NEMA Types 1, 3, 3R, 12, 4, & 4X Enclosures)

CONTROL/POWER SOURCE:  
RSO-IAR-M18



# RSA-53A

FOR USE WITH:  
**ITE/Siemens  
Handle Operator**

## SPECIFICATIONS

OPERATION: Close/Trip

WEIGHT: 16.9 lbs.

DIMENSIONS:\* 10.9" x 12.1" x 7.8"

COMPATIBLE WITH: Enclosure Operating Mechanism for Molded Case Circuit Breakers (Large)

CONTROL/POWER SOURCE:  
RSO-IAR-M18



# RSA-54

FOR USE WITH:  
**Toshiba  
Motor Control Center**

## SPECIFICATIONS

OPERATION: Close/Trip

WEIGHT: 19.2 lbs.

DIMENSIONS:\* 22.5 x 12.5 x 8.5"

COMPATIBLE WITH: JK Series Starter, Controller (includes JK400, JK700, JK, JKSSS, JKSSS4, JKSSS7 Series)

CONTROL/POWER SOURCE:  
RSO-IAR-M18



\*All unit measurements are L x W x H

# RSA-55

FOR USE WITH:

**Siemens**  
**Molded Case Circuit Breaker**

## SPECIFICATIONS

**OPERATION:** Close/Trip

**WEIGHT:** 3.6 lbs.

**DIMENSIONS:**\* 5.7" x 4.6" x 4.6"

**COMPATIBLE WITH:** Type BL, BLH, Single Pole (10-70 A)

**CONTROL/POWER SOURCE:** RSO-IAR-M18



# RSA-55A

FOR USE WITH:

**Siemens**  
**Molded Case Circuit Breaker**

## SPECIFICATIONS

**OPERATION:** Close/Trip

**WEIGHT:** 6.9 lbs.

**DIMENSIONS:**\* 6.7" x 5.4" x 5.1"

**COMPATIBLE WITH:** Type BL, BLH, Two Pole (10-100 A)

**CONTROL/POWER SOURCE:** RSO-IAR-M18

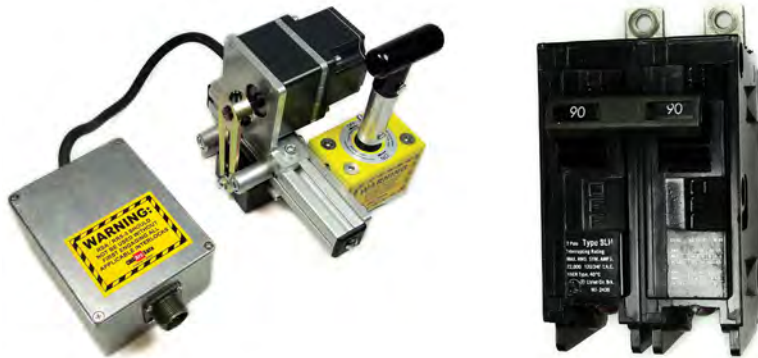

# RSA-56

FOR USE WITH:

**General Electric**  
**Molded Case Circuit Breaker**

## SPECIFICATIONS

**OPERATION:** Close/Trip

**WEIGHT:** 3.6 lbs.

**DIMENSIONS:**\* 6.5" x 4.6" x 4.6"

**COMPATIBLE WITH:** Q-Line, Single Pole (125 A & Less) Type THQB, THHQB, THQC, THHQC, THQL, THHQL, THQP, TQ, TQB, TQC, TQL, TXQB, TXQC, TXQL (does not include DIN Rail Mount & Quick Connect)

**CONTROL/POWER SOURCE:** RSO-IAR-M18



\*All unit measurements are L x W x H

# RSA-56B

FOR USE WITH:  
**General Electric  
Molded Case Circuit Breaker**

## SPECIFICATIONS

OPERATION: Close/Trip

WEIGHT: 7.4 lbs.

DIMENSIONS:\* 8.5" x 5.4" x 5.2"

COMPATIBLE WITH: Q-Line, Three Pole Gang (125 A & Less) Type THQB, THHQB, THQC, THHQC, THQL, THHQL, THQP, TQ, TQB, TQC, TQL, TXQB, TXQC, TXQL (does not include DIN Rail Mount & Quick Connect)

CONTROL/POWER SOURCE: RSO-IAR-M18

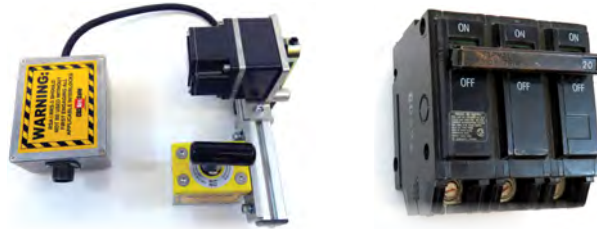

# RSA-56C

FOR USE WITH:  
**General Electric  
Molded Case Circuit Breaker**

## SPECIFICATIONS

OPERATION: Close/Trip

WEIGHT: 8.0 lbs.

DIMENSIONS:\* 5.5" x 8.0" x 4.5"

COMPATIBLE WITH: Q-Line, 2, 3 Pole (100-225A) Type THQD, THQDL, TQD, TQDL

CONTROL/POWER SOURCE:  
RSO-IAR-M18



# RSA-57

FOR USE WITH:  
**Square D  
Molded Case Circuit Breaker**

## SPECIFICATIONS

OPERATION: Close/Trip

WEIGHT: 2.9 lbs.

DIMENSIONS:\* 7.3" x 4.8" x 4.9"

COMPATIBLE WITH: E Frame (15-100 A; includes EH & EM Frames; Flush Mounted; with or without Factory Lockout)

CONTROL/POWER SOURCE:  
RSO-IAR-M18



\*All unit measurements are L x W x H

# RSA-57B

FOR USE WITH:

**Square D  
Molded Case Circuit Breaker**

## SPECIFICATIONS

**OPERATION:** Close/Trip

**WEIGHT:** 5.1 lbs.

**DIMENSIONS:\*** 10.3" x 4.4" x 6.0"

**COMPATIBLE WITH:** F Frame (15-100 A) & K Frame (70-250 A) (Flush Mounted; with or without Factory Lockout; includes FA, FC, FH, FI, FY; KA, KC, KH, KI, KY Frames)

**CONTROL/POWER SOURCE:**  
RSO-IAR-M18

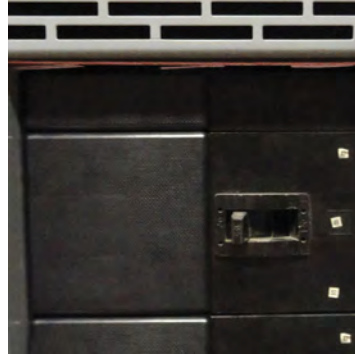

# RSA-57C

FOR USE WITH:

**Square D  
Molded Case Circuit Breaker**

## SPECIFICATIONS

**OPERATION:** Close/Trip

**WEIGHT:** 11.8 lbs.

**DIMENSIONS:\*** 20.3" x 4.7" x 6.5"

**COMPATIBLE WITH:** F Frame (15-100 A) & K Frame (70-250 A) (Recessed Mounted; with or without Factory Lockout; includes FA, FC, FH, FI, FY; KA, KC, KH, KI, KY Frames)

**CONTROL/POWER SOURCE:** RSO-IAR-M18



# RSA-57D

FOR USE WITH:

**Square D  
Molded Case Circuit Breaker**

## SPECIFICATIONS

**OPERATION:** Close/Trip

**WEIGHT:** 11.8 lbs.

**DIMENSIONS:\*** 19.6" x 5.4" x 5.4"

**COMPATIBLE WITH:** L Frame, Q4 Frame (125-400 A, Flush Mounted; with or without Factory Lockout; includes LA, LH, LY, Q4 Frames)

**CONTROL/POWER SOURCE:**  
RSO-IAR-M18



\*All unit measurements are L x W x H

# RSA-57E

FOR USE WITH:

**Square D  
Molded Case Circuit Breaker**

## SPECIFICATIONS

**OPERATION:** Close/Trip

**WEIGHT:** 11.7 lbs.

**DIMENSIONS:**\* 15.6" x 6.0" x 6.1"

**COMPATIBLE WITH:** L Frame, Q4 Frame (125-400 A, Recessed Mounted; with or without Factory Lockout; includes LA, LH, LY, Q4 Frames)

**CONTROL/POWER SOURCE:**  
RSO-IAR-M18



# RSA-57G

FOR USE WITH:

**Square D  
Molded Case Circuit Breaker**

## SPECIFICATIONS

**OPERATION:** Close/Trip

**WEIGHT:** 11.0 lbs.

**DIMENSIONS:**\* 19.6" x 5.6" x 5.7"

**COMPATIBLE WITH:** L Frame (125-400 A, Recessed Mounted; with or without Factory Lockout; includes LC, LI Frames)

**CONTROL/POWER SOURCE:**  
RSO-IAR-M18



# RSA-57I

FOR USE WITH:

**Square D  
Molded Case Circuit Breaker**

## SPECIFICATIONS

**OPERATION:** Close/Trip

**WEIGHT:** 11.8 lbs.

**DIMENSIONS:**\* 15.0" x 9.6" x 5.2"

**COMPATIBLE WITH:** L Frame (125-600 A, Recessed Mounted; with or without Factory Lockout; includes LE, LX Frames)

**CONTROL/POWER SOURCE:**  
RSO-IAR-M18

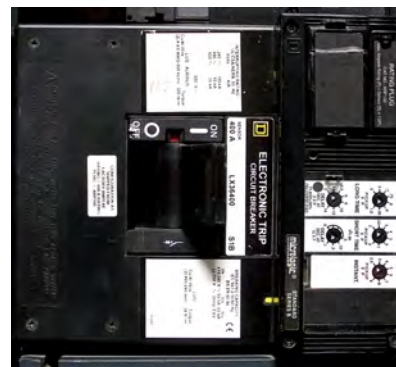

\*All unit measurements are L x W x H

# RSA-57J

FOR USE WITH:

**Square D  
Molded Case Circuit Breaker**

## SPECIFICATIONS

**OPERATION:** Close/Trip

**WEIGHT:** 11.4 lbs.

**DIMENSIONS:**\* 14.6" x 5.7" x 5.7"

**COMPATIBLE WITH:** M Frame (300-1000 A, Flush Mounted; with or without Factory Lockout; includes MA, MH, MY Frames)

**CONTROL/POWER SOURCE:**  
RSO-IAR-M18



# RSA-57K

FOR USE WITH:

**Square D  
Molded Case Circuit Breaker**

## SPECIFICATIONS

**OPERATION:** Close/Trip

**WEIGHT:** 13.5 lbs.

**DIMENSIONS:**\* 17.6" x 5.0" x 6.2"

**COMPATIBLE WITH:** M Frame (300-1000 A, Recessed Mounted; with or without Factory Lockout; includes MA, MH, MY Frames)

**CONTROL/POWER SOURCE:** RSO-IAR-M18



# RSA-57N

FOR USE WITH:

**Square D  
Molded Case Circuit Breaker**

## SPECIFICATIONS

**OPERATION:** Close/Trip

**WEIGHT:** 11.7 lbs.

**DIMENSIONS:**\* 18.6" x 5.1" x 6.3"

**COMPATIBLE WITH:** M Frame (100-800 A, Flush Mounted; with or without Factory Lockout; includes ME, MX Frames)

**CONTROL/POWER SOURCE:**  
RSO-IAR-M18



\*All unit measurements are L x W x H

# RSA-570

FOR USE WITH:

**Square D  
Molded Case Circuit Breaker**

## SPECIFICATIONS

**OPERATION:** Close/Trip

**WEIGHT:** 13.9 lbs.

**DIMENSIONS:**\* 19.6" x 5.5" x 5.9"

**COMPATIBLE WITH:** M Frame (100-800 A, Recessed Mounted; with or without Factory Lockout; includes ME, MX Frames)

**CONTROL/POWER SOURCE:**  
RSO-IAR-M18



# RSA-57P

FOR USE WITH:

**Square D  
Molded Case Circuit Breaker**

## SPECIFICATIONS

**OPERATION:** Close/Trip

**WEIGHT:** 11.0 lbs.

**DIMENSIONS:**\* 24.6" x 5.5" x 8.3"

**COMPATIBLE WITH:** I-Line Molded Case Circuit Breaker (MCCB) N Frame (600-1200 A, Flush Mounted; with or without Factory Lockout; includes NA, NH, NY Frames)

**CONTROL/POWER SOURCE:**  
RSO-IAR-M18



# RSA-57T

FOR USE WITH:

**Square D  
Molded Case Circuit Breaker**

## SPECIFICATIONS

**OPERATION:** Close/Trip

**WEIGHT:** 17.0 lbs.

**DIMENSIONS:**\* 5.5" x 7.0" x 17.3"

**COMPATIBLE WITH:** N Frame (600-1200 A, Flush Mounted; with or without Factory Lockout; includes NE, NX Frames)

**CONTROL/POWER SOURCE:**  
RSO-IAR-M18

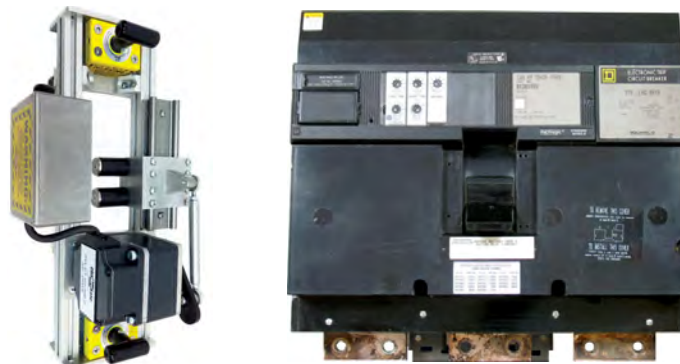

\*All unit measurements are L x W x H

# RSA-57U

FOR USE WITH:

**Square D  
Molded Case Circuit Breaker**

## SPECIFICATIONS

**OPERATION:** Close/Trip

**WEIGHT:** 13.5 lbs.

**DIMENSIONS:**\* 16.8" x 6.9" x 6.0"

**COMPATIBLE WITH:** N Frame (600-1200 A, Recessed Mounted; with or without Factory Lockout; includes NE, NX Frames)

**CONTROL/POWER SOURCE:**  
RSO-IAR-M18



# RSA-57V

FOR USE WITH:

**Square D  
Molded Case Circuit Breaker**

## SPECIFICATIONS

**OPERATION:** Close/Trip

**WEIGHT:** 16.8 lbs.

**DIMENSIONS:**\* 17.6" x 14.6" x 8.0"

**COMPATIBLE WITH:** P Frame (600-2500 A, Flush Mounted; includes PA, PH, PY, PC, PI, PE, PX)

**CONTROL/POWER SOURCE:**  
RSO-IAR-M18



# RSA-59

FOR USE WITH:

**General Electric  
Air Circuit Breaker**

## SPECIFICATIONS

**OPERATION:** Charge/Close/Trip

**WEIGHT:** 16.5 lbs.

**DIMENSIONS:**\* 17.5" x 19.9" x 8.2"

**COMPATIBLE WITH:** WavePro 800-2000 A (WPS, WPH, WPX - 08, 16, 20) & EntelliGuard 800-2000 A (EGS, EGH, EGX - 08, 16, 20)

**CONTROL/POWER SOURCE:**  
RSO-IIID-M18



\*All unit measurements are L x W x H

# RSA-59A

FOR USE WITH:  
**General Electric  
Air Circuit Breaker**

## SPECIFICATIONS

OPERATION: Close/Trip

WEIGHT: 16.5 lbs.

DIMENSIONS:\* 17.5" x 19.9" x 8.2"

COMPATIBLE WITH: WavePro 800-2000 A

CONTROL/POWER SOURCE:  
RSO-IIID-M18



# RSA-59B

FOR USE WITH:  
**General Electric  
Air Circuit Breaker**

## SPECIFICATIONS

OPERATION: Charge/Close/Trip

WEIGHT: 16.5 lbs.

DIMENSIONS:\* 17.5" x 19.9" x 9.7"

COMPATIBLE WITH: WavePro 3200-5000 A (WPS, WPH, WPX - 32, 40, 50) & EntelliGuard 3200-5000 A (EGS, EGH, EGX - 32, 40, 50)

CONTROL/POWER SOURCE:  
RSO-IIID-M18

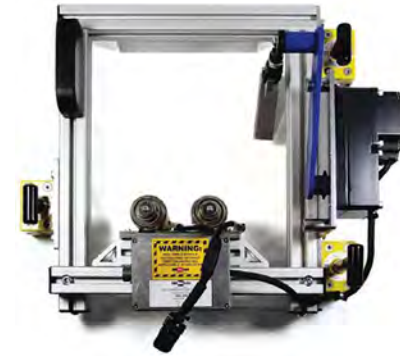

# RSA-59C

FOR USE WITH:  
**General Electric  
Air Circuit Breaker**

## SPECIFICATIONS

OPERATION: Close/Trip

WEIGHT: 16.5 lbs.

DIMENSIONS:\* 17.5" x 19.9" x 9.7"

COMPATIBLE WITH: WavePro 3200-5000 A (WPS, WPH, WPX - 32, 40, 50) & EntelliGuard 3200-5000 A (EGS, EGH, EGX - 32, 40, 50), Close/Trip Only

CONTROL/POWER SOURCE:  
RSO-IIID-M18



\*All unit measurements are L x W x H

# RSA-61

FOR USE WITH:  
**Merlin Gerin  
SF6 Circuit Breaker**

## SPECIFICATIONS

**OPERATION:** Close/Trip  
**WEIGHT:** 7.1 lbs.  
**DIMENSIONS:**\* 9.9" x 6.4" x 5.9"  
**COMPATIBLE WITH:** Type YSF6  
Close/Trip Only  
**CONTROL/POWER SOURCE:**  
RSO-IAR-M18



# RSA-62

FOR USE WITH:  
**General Electric  
Panelboard Switch**

## SPECIFICATIONS

**OPERATION:** Close/Trip  
**WEIGHT:** 8.2 lbs.  
**DIMENSIONS:**\* 16.8" x 6.3" x 6.1"  
**COMPATIBLE WITH:** 300-Line Control  
Non-Reversing Combination Magnetic  
Starter (CR307, CR308, CR387, CR388)  
**CONTROL/POWER SOURCE:**  
RSO-IAR-M18



# RSA-63

FOR USE WITH:  
**Driescher and Wittjohann  
Load Break Switch**

## SPECIFICATIONS

**OPERATION:** Close/Trip  
**WEIGHT:** 37.3 lbs.  
**DIMENSIONS:**\* 38.2" x 11.3" x 8.9"  
**COMPATIBLE WITH:** Driwisa Load  
Break Switch with DW-901 Front  
Mounted Operating Mechanism  
**CONTROL/POWER SOURCE:**  
RSO-IAR-M18

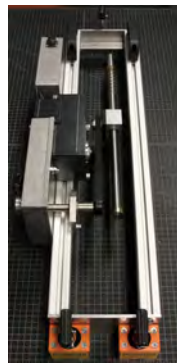

\*All unit measurements are L x W x H

# RSA-64

FOR USE WITH:  
**Westinghouse  
Air Switch**  
*(Close/Trip Assembly)*

## SPECIFICATIONS

**OPERATION:** Charge/Close/Trip  
**WEIGHT:** 28.3 lbs.  
**DIMENSIONS:**\* 28.5" x 13.6" x 9.4"  
**COMPATIBLE WITH:** Type DFS  
**CONTROL/POWER SOURCE:**  
RSO-IIID-M18

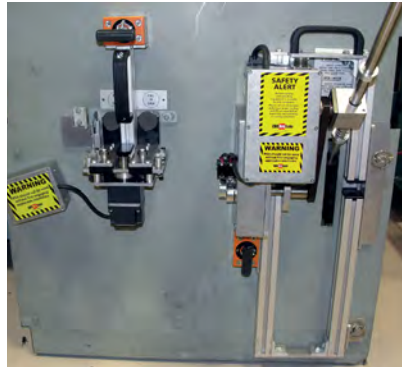

# RSA-65

FOR USE WITH:  
**ABB/BBC/ITE  
Load Interrupter Switch**

## SPECIFICATIONS

**OPERATION:** Close/Trip  
**WEIGHT:** 38.4 lbs.  
**DIMENSIONS:**\* 30.7" x 14.0" x 5.5"  
**COMPATIBLE WITH:** Versa Switch  
Interrupter Switch, Versa Rupter  
Interrupter Switch, HK-HPL-C  
Drawout Interrupter Switch (Flush  
Mounted on Panel)  
**CONTROL/POWER SOURCE:**  
RSO-IAR-M18



# RSA-65A

FOR USE WITH:  
**ABB/BBC/ITE  
Load Interrupter Switch**

## SPECIFICATIONS

**OPERATION:** Close/Trip  
**WEIGHT:** 33.5 lbs.  
**DIMENSIONS:**\* 32.3" x 12.5" x 9.0"  
**COMPATIBLE WITH:** Type HK-HPL-  
C-Drawout Interrupter Switch  
(Recessed)  
**CONTROL/POWER SOURCE:**  
RSO-IAR-M18

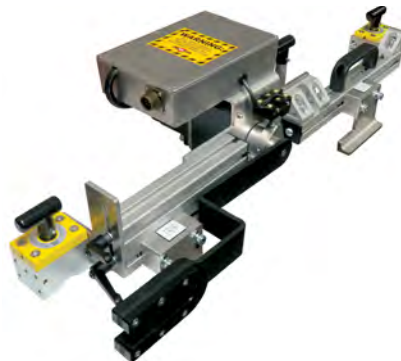

\*All unit measurements are L x W x H

# RSA-66

FOR USE WITH:

**ITE**  
**Molded Case Circuit Breaker**

## SPECIFICATIONS

**OPERATION:** Close/Trip

**WEIGHT:** 6.5 lbs.

**DIMENSIONS:**\* 10.5" x 4.0" x 5.0"

**COMPATIBLE WITH:** Type ET/ETI/ETO/ET-75/ET-C Molded Case Circuit Breaker (MCCB) E Frame 15-100 A

**CONTROL/POWER SOURCE:**  
RSO-IAR-M18



# RSA-66A

FOR USE WITH:

**ITE**  
**Molded Case Circuit Breaker**

## SPECIFICATIONS

**OPERATION:** Close/Trip

**WEIGHT:** 8.1 lbs.

**DIMENSIONS:**\* 9.3" x 4.4" x 6.6"

**COMPATIBLE WITH:** Type ET, ETI, ETO, ET-75, ET-C Molded Case Circuit Breaker (MCCB) F Frame (15-100 A, includes F, HF, CF) - 2, 3 Pole

**CONTROL/POWER SOURCE:**  
RSO-IAR-M18

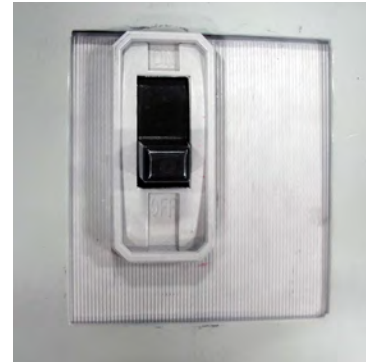
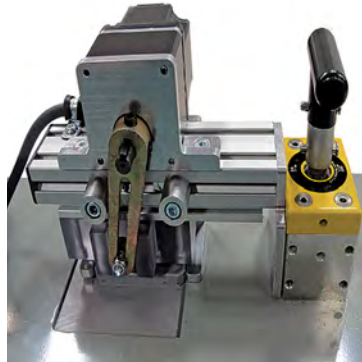

# RSA-66C

FOR USE WITH:

**ITE**  
**Molded Case Circuit Breaker**

## SPECIFICATIONS

**OPERATION:** Close/Trip

**WEIGHT:** 9.5 lbs.

**DIMENSIONS:**\* 15.6" x 6.1" x 5.4"

**COMPATIBLE WITH:** Type ET, ETI, ETO, ET-75, ET-C Molded Case Circuit Breaker (MCCB) J Frame (70-225 A, includes J, JJ, JKL, JL, CJKL) & HJKL Frame (125-400 A, includes HJ, HJKL) - 2-3 Pole

**CONTROL/POWER SOURCE:**  
RSO-IAR-M18



\*All unit measurements are L x W x H

# RSA-66G

FOR USE WITH:

**ITE**  
**Molded Case Circuit Breaker**

## SPECIFICATIONS

**OPERATION:** Close/Trip

**WEIGHT:** 17.3 lbs.

**DIMENSIONS:**\* 19.3" x 7.0" x 6.3"

**COMPATIBLE WITH:** Type ET, ET1, ETO, ET-75, ET-C Molded Case Circuit Breaker (MCCB) - KM Frame (250-800 A, includes KM), KP Frame (250-800 A, includes KP), HP Frame (800-1600 A, includes HP), & CP Frame (800-1600 A, includes CP) - 2, 3 Pole

**CONTROL/POWER SOURCE:** RSO-IAR-M18



# RSA-67

FOR USE WITH:

**Powell Control Industries**  
**Molded Case Circuit Breaker**

## SPECIFICATIONS

**OPERATION:** Close/Trip

**WEIGHT:** 24.0 lbs.

**DIMENSIONS:**\* 16.6" x 11.7" x 5.2"

**COMPATIBLE WITH:** Series P-13000 Class E-2 Controller (2.5-5 kV Voltage Class)

**CONTROL/POWER SOURCE:** RSO-IAR-M18



# RSA-69A

FOR USE WITH:

**ABB/SACE**  
**Insulated Case Circuit Breaker**

## SPECIFICATIONS

**OPERATION:** Close/Trip

**WEIGHT:** 13.5 lbs.

**DIMENSIONS:**\* 6.6" x 7.9" x 21.7"

**COMPATIBLE WITH:** Megamax F Low-Voltage Power Circuit Breaker, 1200-6000 A, All Sizes (F1, F2, F3, F4, F5, F6)

**CONTROL/POWER SOURCE:** RSO-IAR-M18



\*All unit measurements are L x W x H

# RSA-69C

FOR USE WITH:  
**ABB/SACE**  
**Insulated Case Circuit Breaker**

## SPECIFICATIONS

**OPERATION:** Charge/Close/Trip  
**WEIGHT:** 30.0 lbs.  
**DIMENSIONS:\*** 23.5" x 16.5" x 6.5"  
**COMPATIBLE WITH:** Megamax F  
F3-F6 C/C/T  
**CONTROL/POWER SOURCE:**  
RSO-IAR-M18



# RSA-69D

FOR USE WITH:  
**ABB/SACE**  
**Insulated Case Circuit Breaker**

## SPECIFICATIONS

**OPERATION:** Close/Trip  
**WEIGHT:** 17.0 lbs.  
**DIMENSIONS:\*** 23.5" x 16.5" x 6.0"  
**COMPATIBLE WITH:** Megamax F  
F3-F6 C/T  
**CONTROL/POWER SOURCE:**  
RSO-IAR-M18



# RSA-71

FOR USE WITH:  
**Allen-Bradley**  
**Motor Control Center**

## SPECIFICATIONS

**OPERATION:** Close/Trip  
**WEIGHT:** 13.8 lbs.  
**DIMENSIONS:\*** 13.0" x 7.2" x 7.8"  
**COMPATIBLE WITH:** Centerline 5  
kV Starter (First Generation, Gray  
Metal Handle Operator)  
**CONTROL/POWER SOURCE:**  
RSO-IAR-M18



\*All unit measurements are L x W x H

# RSA-71B

FOR USE WITH:  
**Allen-Bradley  
Motor Control Center**

## SPECIFICATIONS

OPERATION: Close/Trip

WEIGHT: 14.0 lbs.

DIMENSIONS: \* 12.8" x 7.2" x 6.1"

COMPATIBLE WITH: Centerline 5 kV Starter (Flush Mounted, Second Generation, Red & Black Plastic Handle Operator)

CONTROL/POWER SOURCE:  
RSO-IAR-M18



# RSA-71C

FOR USE WITH:  
**Allen-Bradley  
Handle Operator**

## SPECIFICATIONS

OPERATION: Close/Trip

WEIGHT: 13.8 lbs.

DIMENSIONS: 13" x 7.1" x 7.2"

COMPATIBLE WITH: Centerline 5 kV Starter (Recessed Mounted, Second Generation, Red & Black Plastic Handle Operator)

CONTROL/POWER SOURCE:  
RSO-IAR-M18



# RSA-72

FOR USE WITH:  
**General Electric  
Molded Case Circuit Breaker**

## SPECIFICATIONS

OPERATION: Close/Trip

WEIGHT: 18.6 lbs.

DIMENSIONS: \* 20.6" x 7.3" x 6.6"

COMPATIBLE WITH: Spectra Series Molded Case Circuit Breaker (MCCB) SK Frame: 300-1200 A (includes SKD, SKH, SKL, SKP) - Flush Mount without Handle Extension

CONTROL/POWER SOURCE: RSO-IAR-M18



\*All unit measurements are L x W x H

# RSA-72A

FOR USE WITH:

**General Electric  
Molded Case Circuit Breaker**

## SPECIFICATIONS

**OPERATION:** Close/Trip

**WEIGHT:** 18.2 lbs.

**DIMENSIONS:**\* 18.2" x 7.3" x 6.6"

**COMPATIBLE WITH:** Spectra Series Molded Case Circuit Breaker (MCCB) SK Frame: 300-1200 A (includes SKD, SKH, SKL, SKP) - Flush Mount with Handle Extension

**CONTROL/POWER SOURCE:**  
RSO-IAR-M18



# RSA-72B

FOR USE WITH:

**General Electric  
Molded Case Circuit Breaker**

## SPECIFICATIONS

**OPERATION:** Close/Trip

**WEIGHT:** 10.1 lbs.

**DIMENSIONS:**\* 15.5" x 5.5" x 4.4"

**COMPATIBLE WITH:** Spectra Series Molded Case Circuit Breaker (MCCB) SG Frame: 125-600 A (includes SGD, SGK, SGL, SGP) - Flush Mount

**CONTROL/POWER SOURCE:**  
RSO-IAR-M18



# RSA-72C

FOR USE WITH:

**General Electric  
Molded Case Circuit Breaker**

## SPECIFICATIONS

**OPERATION:** Close/Trip

**WEIGHT:** 8.2 lbs.

**DIMENSIONS:**\* 8.3" x 4.4" x 6.6"

**COMPATIBLE WITH:** Spectra Series Molded Case Circuit Breaker (MCCB) SE Frame: 15-100 A (includes SED, SEH, SEL, SEP); SF Frame: 70-250 A (includes SFD, SFH, SFL, SFP) - Flush Mount

**CONTROL/POWER SOURCE:**  
RSO-IAR-M18



\*All unit measurements are L x W x H

# RSA-72D

FOR USE WITH:

**General Electric  
Molded Case Circuit Breaker**

## SPECIFICATIONS

**OPERATION:** Close/Trip

**WEIGHT:** 17.2 lbs.

**DIMENSIONS:**\* 20.1" x 7.3" x 6.3"

**COMPATIBLE WITH:** Spectra Series Molded Case Circuit Breaker (MCCB) SK Frame: 300-1200 A (includes SKD, SKH, SKL, SKP) - Recessed Mount with Handle Extension

**CONTROL/POWER SOURCE:**  
RSO-IAR-M18

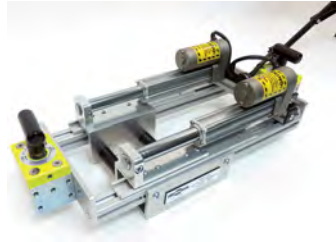

# RSA-73

FOR USE WITH:

**General Electric  
Bolted Pressure Switch**

## SPECIFICATIONS

**OPERATION:** Charge/Close/Trip

**WEIGHT:** 23.4 lbs.

**DIMENSIONS:**\* 11.1" x 14.7" x 9.1"

**COMPATIBLE WITH:** Type HPC High Pressure Contact Switch 2000-4000 A (Manual or Electric Trip, Bottom Feed Standard)

**CONTROL/POWER SOURCE:**  
RSO-IIID-M18



# RSA-73A

FOR USE WITH:

**General Electric  
Bolted Pressure Switch**

## SPECIFICATIONS

**OPERATION:** Charge/Close/Trip

**WEIGHT:** 22.0 lbs.

**DIMENSIONS:**\* 7.5" x 24.5" x 8.8"

**COMPATIBLE WITH:** Type HPC High Pressure Contact Switch 800-1600 A (Manual or Electric Trip, Bottom Feed Standard)

**CONTROL/POWER SOURCE:**  
RSO-IIID-M18



\*All unit measurements are L x W x H

# RSA-73B

FOR USE WITH:

**General Electric  
Bolted Pressure Switch**

## SPECIFICATIONS

**OPERATION:** Charge/Close/Trip

**WEIGHT:** 21.8 lbs.

**DIMENSIONS:**\* 7.5" x 9.0" x 18.5"

**COMPATIBLE WITH:** Type HPC High Pressure Contact Switch 800-1600 A (Manual or Electric Trip, Top Feed Inverted)

**CONTROL/POWER SOURCE:**  
RSO-IIID-M18



# RSA-73C

FOR USE WITH:

**General Electric  
Bolted Pressure Switch**

## SPECIFICATIONS

**OPERATION:** Charge/Close/Trip

**WEIGHT:** 23.4 lbs.

**DIMENSIONS:**\* 11.1" x 14.7" x 9.1"

**COMPATIBLE WITH:** Type HPC High Pressure Contact Switch 2000-4000 A (Manual or Electric Trip, Top Feed Inverted)

**CONTROL/POWER SOURCE:**  
RSO-IIID-M18

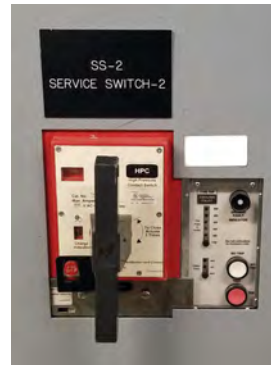

# RSA-76

FOR USE WITH:

**General Electric  
Insulated Case Circuit Breaker**



## SPECIFICATIONS

**OPERATION:** Charge/Close/Trip

**WEIGHT:** 25.6 lbs.

**DIMENSIONS:**\* 13.2" x 20.8" x 7.1"

**COMPATIBLE WITH:** Power Break II - All Frame Sizes (Door Closed)

**CONTROL/POWER SOURCE:**  
RSO-IIID-M18



\*All unit measurements are L x W x H

# RSA-76C

FOR USE WITH:

**General Electric  
Insulated Case Circuit Breaker**

## SPECIFICATIONS

**OPERATION:** Close/Trip

**WEIGHT:** 13.0 lbs.

**DIMENSIONS:**\* 18.6" x 5.4" x 7.0"

**COMPATIBLE WITH:** Power Break II - All Frame Sizes (Door Closed)

**CONTROL/POWER SOURCE:** RSO-IIID-M18



# RSA-76E

FOR USE WITH:

**General Electric  
Insulated Case Circuit Breaker**

## SPECIFICATIONS

**OPERATION:** Close/Trip

**WEIGHT:** 25.9 lbs.

**DIMENSIONS:**\* 13.3" x 21.1" x 8.4"

**COMPATIBLE WITH:** Power Break II - All Frame Sizes (Door Closed, Protruding Mount, Up to 2.5")

**CONTROL/POWER SOURCE:** RSO-IIID-M18



# RSA-77

FOR USE WITH:

**ITE/Gould/Siemens  
Motor Control Center**

## SPECIFICATIONS

**OPERATION:** Close/Trip

**WEIGHT:** 10.0 lbs.

**DIMENSIONS:**\* 9.7" x 9.4" x 7.0"

**COMPATIBLE WITH:** 5600 Series Motor Control Center (MCC) 5640, Version 1, Metallic Rotary Handle, Size 1-4

**CONTROL/POWER SOURCE:** RSO-IAR-M18



\*All unit measurements are L x W x H

# RSA-78

## SPECIFICATIONS

**OPERATION:** Close/Trip

**WEIGHT:** 8.9 lbs.

**DIMENSIONS:**\* 11.7" x 7.3" x 5.6"

**COMPATIBLE WITH:** F2100 Advantage Series 2100, 5 Star Motor Control Center (MCC) Bucket Size 1-5

**CONTROL/POWER SOURCE:** RSO-IAR-M18

FOR USE WITH:

**Cutler-Hammer/Westinghouse Motor Control Center**



# RSA-78A

## SPECIFICATIONS

**OPERATION:** Close/Trip

**WEIGHT:** 12 lbs.

**DIMENSIONS:**\* 21.6" x 7.4" x 5.7"

**COMPATIBLE WITH:** F2100 Advantage Series 2100, 5 Star Motor Control Center (MCC) Main

**CONTROL/POWER SOURCE:** RSO-IAR-M18

FOR USE WITH:

**Cutler-Hammer/Westinghouse Motor Control Center**



# RSA-79

## SPECIFICATIONS

**OPERATION:** Charge/Close/Trip

**WEIGHT:** 25.2 lbs.

**DIMENSIONS:**\* 15.2" x 10.6" x 10.0"

**COMPATIBLE WITH:** Type KA, KB, KC, KD, KE

**CONTROL/POWER SOURCE:** RSO-IAR-M18

FOR USE WITH:

**ITE Air Circuit Breaker**



\*All unit measurements are L x W x H

# RSA-79A

FOR USE WITH:

**ITE**  
**Air Circuit Breaker**

## SPECIFICATIONS

**OPERATION:** Charge/Close/Trip

**WEIGHT:** 23.2 lbs.

**DIMENSIONS:**\* 14.5" x 10.6" x 9.8"

**COMPATIBLE WITH:** Type KA, KB, KC, KD, KE (Flush Mount)

**CONTROL/POWER SOURCE:**  
RSO-IAR-M18



# RSA-80

FOR USE WITH:

**Westinghouse**  
**Air Circuit Breaker**

## SPECIFICATIONS

**OPERATION:** Charge/Close/Trip

**WEIGHT:** 23.9 lbs.

**DIMENSIONS:**\* 14.6" x 14.9" x 8.1"

**COMPATIBLE WITH:** Type DB-15, 25, 15-600 A (Three Position, Rectangular Trip Button Above Charging Handle)

**CONTROL/POWER SOURCE:**  
RSO-IIID-M18



# RSA-80A

FOR USE WITH:

**Westinghouse**  
**Air Circuit Breaker**

## SPECIFICATIONS

**OPERATION:** Close/Trip

**WEIGHT:** 18.3 lbs.

**DIMENSIONS:**\* 10.8" x 10.8" x 8.3"

**COMPATIBLE WITH:** Type DB-15, 25, 15-600 A (Single Position, No Trip Button)

**CONTROL/POWER SOURCE:**  
Specify Usage



\*All unit measurements are L x W x H

# RSA-82

## SPECIFICATIONS

**OPERATION:** Close/Trip

**WEIGHT:** 8.2 lbs.

**DIMENSIONS:**\* 12.5" x 5.5" x 5.6"

**COMPATIBLE WITH:** Marq21, Model 90, Model 95, Model 95+ Motor Control Center (MCC) Bucket, Size 1-4 (Black Plastic Handle with Green Sides)

**CONTROL/POWER SOURCE:**  
RSO-IAR-M18

FOR USE WITH:

**Siemens/Siemens-Allis  
Motor Control Center**



# RSA-82A

## SPECIFICATIONS

**OPERATION:** Close/Trip

**WEIGHT:** 11.5 lbs.

**DIMENSIONS:**\* 13.6" x 5.3" x 5.2"

**COMPATIBLE WITH:** MarQ21, Model-90, Model-95 Size 5

**CONTROL/POWER SOURCE:**  
RSO-IAR-M18

FOR USE WITH:

**Siemens/Siemens-Allis  
Motor Control Center**



# RSA-83

## SPECIFICATIONS

**OPERATION:** Close/Trip

**WEIGHT:** 10.2 lbs.

**DIMENSIONS:**\* 7.9" x 5.6" x 4.4"

**COMPATIBLE WITH:** System 89 Motor Control Center (MCC) Size 1-4 & Tiastar (Flush Mounted, Rectangular Handle Operator, Vertical & Horizontal)

**CONTROL/POWER SOURCE:**  
RSO-IAR-M18

FOR USE WITH:

**Furnas/Siemens-Furnas/Siemens  
Motor Control Center**



\*All unit measurements are L x W x H

# RSA-83A

FOR USE WITH:

**Furnas/Siemens-Furnas/Siemens  
Motor Control Center**

## SPECIFICATIONS

OPERATION: Close/Trip

WEIGHT: 9.0 lbs.

DIMENSIONS:\* 11.4" x 7.3" x 5.2"

COMPATIBLE WITH: System 89  
Motor Control Center (MCC) Tiastar  
(Triangular Handle Style) Size 1-4

CONTROL/POWER SOURCE:  
RSO-IAR-M18



# RSA-83C

FOR USE WITH:

**Furnas/Siemens-Furnas/Siemens  
Motor Control Center**

## SPECIFICATIONS

OPERATION: Close/Trip

WEIGHT: 6.5 lbs.

DIMENSIONS:\* 14.3" x 5.4" x 5.0"

COMPATIBLE WITH: System 89  
Motor Control Center (MCC) Starter/  
Disconnect Handle (Red - Circular  
Handle Tip)

CONTROL/POWER SOURCE:  
RSO-IAR-M18



# RSA-83D

FOR USE WITH:

**Furnas/Siemens-Furnas/Siemens  
Motor Control Center**

## SPECIFICATIONS

OPERATION: Close/Trip

WEIGHT: 7.5 lbs.

DIMENSIONS:\* 16.3" x 5.9" x 5.7"

COMPATIBLE WITH: System 89  
Motor Control Center (MCC) Starter/  
Disconnect Handle (Red & Green  
- Rectangular)

CONTROL/POWER SOURCE:  
RSO-IAR-M18



\*All unit measurements are L x W x H

# RSA-85

FOR USE WITH:  
**Square D  
Motor Control Center**

## SPECIFICATIONS

**OPERATION:** Close/Trip

**WEIGHT:** 10.0 lbs.

**DIMENSIONS:**\* 9.4" x 7.3" x 8.0"

**COMPATIBLE WITH:** Model 3 Motor Control Center (MCC) Size 1-4

**CONTROL/POWER SOURCE:** RSO-IAR-M18



# RSA-86

FOR USE WITH:  
**ITE/Gould/Telemecanique  
Motor Control Center**

## SPECIFICATIONS

**OPERATION:** Close/Trip

**WEIGHT:** 11.0 lbs.

**DIMENSIONS:**\* 8.6" x 6.0" x 8.0"

**COMPATIBLE WITH:** 9600 Series Motor Control Center (MCC) Metallic Rotary Lever, Size 1-4 MCC Bucket

**CONTROL/POWER SOURCE:** RSO-IAR-M18



# RSA-87

FOR USE WITH:  
**Cutler-Hammer  
Motor Control Center**

## SPECIFICATIONS

**OPERATION:** Close/Trip

**WEIGHT:** 5.2 lbs.

**DIMENSIONS:**\* 7.5" x 5.7" x 5.8"

**COMPATIBLE WITH:** F10 Unitrol, 9800 Unitrol Motor Control Center (MCC) Bucket - Slider Style Operating Handle Mechanism, Size 1-4 MCC Bucket (including 6" Horizontal Feeder Bucket)

**CONTROL/POWER SOURCE:** RSO-IAR-M18



\*All unit measurements are L x W x H

# RSA-87A

FOR USE WITH:  
**Cutler-Hammer  
Motor Control Center**

## SPECIFICATIONS

OPERATION: Close/Trip

WEIGHT: 8.1 lbs.

DIMENSIONS:\* 8.5" x 5.7" x 6.4"

COMPATIBLE WITH: F10 Unitrol, 9800 Unitrol Motor Control Center (MCC) Bucket - Slider Style Operating Handle Mechanism, Size 5 MCC Bucket

CONTROL/POWER SOURCE: RSO-IAR-M18



# RSA-89

FOR USE WITH:  
**Cutler-Hammer  
Motor Control Center**

## SPECIFICATIONS

OPERATION: Close/Trip

WEIGHT: 15.3 lbs.

DIMENSIONS:\* 11.5" x 9.2" x 7.8"

COMPATIBLE WITH: 9800 Unitrol Size 1-4 Motor Control Center (MCC) Bucket

CONTROL/POWER SOURCE: RSO-IAR-M18

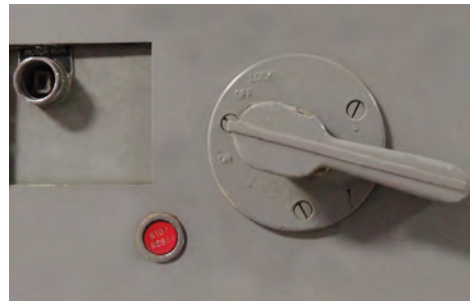

# RSA-89A

FOR USE WITH:  
**Cutler-Hammer  
Motor Control Center**

## SPECIFICATIONS

OPERATION: Charge/Close/Trip

WEIGHT: 15.3 lbs.

DIMENSIONS:\* 11.5" x 9.2" x 7.8"

COMPATIBLE WITH: 9800 Unitrol Size 5 Motor Control Center (MCC) Bucket

CONTROL/POWER SOURCE: RSO-IAR-M18



\*All unit measurements are L x W x H

# RSA-90

## SPECIFICATIONS

**OPERATION:** Charge/Close/Trip

**WEIGHT:** 19.0 lbs.

**DIMENSIONS:**\* 11.0" x 12.0" x 10.0"

**COMPATIBLE WITH:** AK-1-25 (Trip Button in Handle)

**CONTROL/POWER SOURCE:**  
RSO-IAR-M18

FOR USE WITH:

**General Electric  
Air Circuit Breaker**



# RSA-91

## SPECIFICATIONS

**OPERATION:** Close/Trip

**WEIGHT:** 15.5 lbs.

**DIMENSIONS:**\* 16.0" x 8.8" x 7.5"

**COMPATIBLE WITH:** Power Break - Manual, Electric, 800-2000 A (No Trip Unit Visible on Panel)

**CONTROL/POWER SOURCE:**  
RSO-IAR-M18

FOR USE WITH:

**General Electric  
Insulated Case Circuit Breaker**



# RSA-91E

## SPECIFICATIONS

**OPERATION:** Charge/Close/Trip

**WEIGHT:** 19.9 lbs.

**DIMENSIONS:**\* 16.0" x 8.8" x 9.5"

**COMPATIBLE WITH:** Power Break - Electrically Operated, 800-2000 A (No Trip Unit Visible on Panel)

**CONTROL/POWER SOURCE:**  
RSO-IIID-M18

FOR USE WITH:

**General Electric  
Insulated Case Circuit Breaker**



\*All unit measurements are L x W x H

# RSA-91M

FOR USE WITH:

**General Electric  
Insulated Case Circuit Breaker**

## SPECIFICATIONS

**OPERATION:** Charge/Close/Trip

**WEIGHT:** 24.1 lbs.

**DIMENSIONS:**\* 16.0" x 8.8" x 8.7"

**COMPATIBLE WITH:** Power Break -  
Manually Operated, 800-2000 A (No  
Trip Unit Visible on Panel)

**CONTROL/POWER SOURCE:**  
RSO-IIID-M18

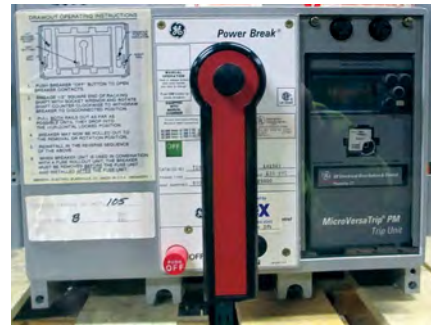

# RSA-91A

FOR USE WITH:

**General Electric  
Insulated Case Circuit Breaker**

## SPECIFICATIONS

**OPERATION:** Close/Trip

**WEIGHT:** 15.5 lbs.

**DIMENSIONS:**\* 16.0" x 8.8" x 7.5"

**COMPATIBLE WITH:** Power Break -  
Manual, Electric, 2500-4000 A (Trip  
Unit Below)

**CONTROL/POWER SOURCE:**  
Specify Usage



# RSA-91A E

FOR USE WITH:

**General Electric  
Insulated Case Circuit Breaker**

## SPECIFICATIONS

**OPERATION:** Charge/Close/Trip

**WEIGHT:** 23.0 lbs.

**DIMENSIONS:**\* 18.9" x 9.8" x 10.4"

**COMPATIBLE WITH:** Power Break -  
Electrically Operated, 2500-4000 A (Trip  
Unit Below)

**CONTROL/POWER SOURCE:**  
RSO-IIID-M18



\*All unit measurements are L x W x H

# RSA-91A M

FOR USE WITH:

**General Electric  
Insulated Case Circuit Breaker**

## SPECIFICATIONS

**OPERATION:** Charge/Close/Trip

**WEIGHT:** 25.0 lbs.

**DIMENSIONS:**\* 18.9" x 9.8" x 9.6"

**COMPATIBLE WITH:** Power Break - Manually Operated, 2500-4000 A (Trip Unit Below)

**CONTROL/POWER SOURCE:** RSO-IIID-M18

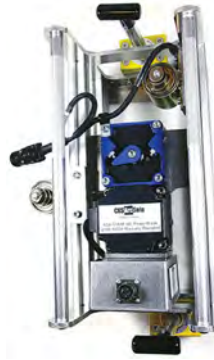

# RSA-91B M

FOR USE WITH:

**General Electric  
Insulated Case Circuit Breaker**

## SPECIFICATIONS

**OPERATION:** Charge/Close/Trip

**WEIGHT:** 23.8 lbs.

**DIMENSIONS:**\* 8.8" x 8.8" x 16.0"

**COMPATIBLE WITH:** Power Break - Manually Operated, 800-2000 A (With Kirk Key Interlock Housing on Left)

**CONTROL/POWER SOURCE:** RSO-IIID-M18



# RSA-91C E

FOR USE WITH:

**General Electric  
Insulated Case Circuit Breaker**

## SPECIFICATIONS

**OPERATION:** Charge/Close/Trip

**WEIGHT:** 21.4 lbs.

**DIMENSIONS:**\* 18.9" x 8.8" x 10.4"

**COMPATIBLE WITH:** Power Break - Electrically Operated, 2500-4000 A (Trip Unit Above & Below)

**CONTROL/POWER SOURCE:** RSO-IIID-M18



No  
Image  
Found



\*All unit measurements are L x W x H

# RSA-91C M

FOR USE WITH:

**General Electric  
Insulated Case Circuit Breaker**

## SPECIFICATIONS

**OPERATION:** Charge/Close/Trip

**WEIGHT:** 21.0 lbs.

**DIMENSIONS:**\* 22.1" x 9.8" x 9.6"

**COMPATIBLE WITH:** Power Break - Manually Operated, 2500-4000 A (Trip Unit Above & Below)

**CONTROL/POWER SOURCE:** RSO-IIID-M18



# RSA-95

FOR USE WITH:

**Westinghouse  
Air Circuit Breaker**

## SPECIFICATIONS

**OPERATION:** Charge/Close/Trip

**WEIGHT:** 29.0 lbs.

**DIMENSIONS:**\* 16.9" x 12.7" x 9.6"

**COMPATIBLE WITH:** Type DB-50, 200-1600 A (Three Position, Rectangular Trip Button Above Charging Handle)

**CONTROL/POWER SOURCE:** RSO-IIID-M18



# RSA-95A

FOR USE WITH:

**Westinghouse  
Air Circuit Breaker**

## SPECIFICATIONS

**OPERATION:** Close/Trip

**WEIGHT:** 20.5 lbs.

**DIMENSIONS:**\* 11.9" x 11.8" x 7.8"

**COMPATIBLE WITH:** Type DB-50, 200-1600 A (Single Position, No Trip Button)

**CONTROL/POWER SOURCE:** RSO-IIID-M18



\*All unit measurements are L x W x H

# RSA-96

FOR USE WITH:  
**ABB/SACE**  
**Insulated Case Circuit Breaker**

## SPECIFICATIONS

**OPERATION:** Charge/Close/Trip

**WEIGHT:** 23.8 lbs.

**DIMENSIONS:\*** 20.8" x 17.0" x 7.7"

**COMPATIBLE WITH:** Emax 800-6000 A, All Sizes (E1, E2, E3, E4, E5, E6) & Tmax Molded Case Circuit Breakers (MCCBs) 1600-3000 A (T8 only)

**CONTROL/POWER SOURCE:**  
RSO-IIID-M18



# RSA-96A

FOR USE WITH:  
**ABB/SACE**  
**Insulated Case Circuit Breaker**

## SPECIFICATIONS

**OPERATION:** Close/Trip

**WEIGHT:** 12.0 lbs.

**DIMENSIONS:\*** 20.8" x 6.5" x 5.3"

**COMPATIBLE WITH:** Emax E1, E2, E3, E4, E5, E6

**CONTROL/POWER SOURCE:**  
RSO-IIID-M18



# RSA-96C

FOR USE WITH:  
**ABB/SACE**  
**Insulated Case Circuit Breaker**

## SPECIFICATIONS

**OPERATION:** Close/Trip

**WEIGHT:** 12.0 lbs.

**DIMENSIONS:\*** 17.9" x 7.0" x 6.0"

**COMPATIBLE WITH:** Emax2, 1.2 Only

**CONTROL/POWER SOURCE:**  
RSO-IIID-M18



\*All unit measurements are L x W x H

# RSA-96D

FOR USE WITH:

**ABB/SACE**  
**Insulated Case Circuit Breaker**

## SPECIFICATIONS

OPERATION: Charge/Close/Trip

WEIGHT: 27.5 lbs.

DIMENSIONS:\* 20.8" x 16.3" x 17.5"

COMPATIBLE WITH: Emax2, 2.2,4.2,6.2

CONTROL/POWER SOURCE:  
RSO-IIID-M18



# RSA-96E

FOR USE WITH:

**ABB/SACE**  
**Insulated Case Circuit Breaker**

## SPECIFICATIONS

OPERATION: Close/Trip

WEIGHT: 15.0 lbs.

DIMENSIONS:\* 16.7" x 19.8" x 6.0"

COMPATIBLE WITH: Emax2, 2.2,4.2,6.3

CONTROL/POWER SOURCE:  
RSO-IIID-M18



# RSA-97

FOR USE WITH:

**Square D**  
**Motor Control Center**

## SPECIFICATIONS

OPERATION: Close/Trip

WEIGHT: 7.2 lbs.

DIMENSIONS:\* 7.7" x 5.9" x 4.4"

COMPATIBLE WITH: Model 4 Motor  
Control Center (MCC) Bucket Size 1-4

CONTROL/POWER SOURCE:  
RSO-IAR-M18



\*All unit measurements are L x W x H

# RSA-97A

FOR USE WITH:

**Square D  
Motor Control Center**

## SPECIFICATIONS

**OPERATION:** Close/Trip

**WEIGHT:** 14.8 lbs.

**DIMENSIONS:**\* 11.6" x 7.8" x 5.4"

**COMPATIBLE WITH:** Model 4 Motor Control Center (MCC) Bucket Size 5

**CONTROL/POWER SOURCE:**  
RSO-IAR-M18



# RSA-97B

FOR USE WITH:

**Square D  
Motor Control Center**

## SPECIFICATIONS

**OPERATION:** Close/Trip

**WEIGHT:** 14.0 lbs.

**DIMENSIONS:**\* 12.5" x 7.6" x 10.2"

**COMPATIBLE WITH:** Model 4 Motor Control Center (MCC) Bucket Size 5 Recessed

**CONTROL/POWER SOURCE:**  
RSO-IAR-M18



# RSA-99

FOR USE WITH:

**Clark/Sylvania  
Motor Control Center**

## SPECIFICATIONS

**OPERATION:** Close/Trip

**WEIGHT:** 14.8 lbs.

**DIMENSIONS:**\* 11.6" x 7.8" x 5.4"

**COMPATIBLE WITH:** 6200 Motor Control Center (MCC) Bucket

**CONTROL/POWER SOURCE:**  
RSO-IAR-M18



\*All unit measurements are L x W x H

# RSA-100A

FOR USE WITH:

**Square D/GTE/Sylvania  
Bolted Pressure Switch**

## SPECIFICATIONS

**OPERATION:** Close/Trip

**WEIGHT:** 9.5 lbs.

**DIMENSIONS:**\* 7.5" x 7.0" x 9.0"

**COMPATIBLE WITH:** Bolt-Loc BP Series, Close/Trip System Only, Teardrop Style 2500-4000 A Frame

**CONTROL/POWER SOURCE:** RSO-IIID-M18



# RSA-100B

FOR USE WITH:

**Square D/GTE/Sylvania  
Bolted Pressure Switch**

## SPECIFICATIONS

**OPERATION:** Charge/Close/Trip

**WEIGHT:** 39.0 lbs.

**DIMENSIONS:**\* 29.5" x 16.9" x 11.0"

**COMPATIBLE WITH:** Bolt-Loc BP Series 800-2000 A (with Paddle Trip Above Close Handle)

**CONTROL/POWER SOURCE:** RSO-IIID-M18



# RSA-100C

FOR USE WITH:

**Square D/GTE/Sylvania  
Bolted Pressure Switch**

## SPECIFICATIONS

**OPERATION:** Close/Trip

**WEIGHT:** 37.0 lbs.

**DIMENSIONS:**\* 24.5" x 20.5" x 12.0"

**COMPATIBLE WITH:** Bolt-Loc BL Series Close/Trip System 1600-4000 A Frame

**CONTROL/POWER SOURCE:** RSO-IIID-M18



\*All unit measurements are L x W x H

# RSA-102

## SPECIFICATIONS

**OPERATION:** Close/Trip

**WEIGHT:** 18 lbs.

**DIMENSIONS:**\* 18" x 15" x 10"

**COMPATIBLE WITH:** Switchmatic Disconnect Switch QMQB Series 400 A (Black Plastic Handle Operator with Red Sticker)

**CONTROL/POWER SOURCE:**  
RSO-IAR-M18

FOR USE WITH:

**Federal Pacific Electric  
Panelboard Switch**



# RSA-102C

## SPECIFICATIONS

**OPERATION:** Close/Trip

**WEIGHT:** 15.0 lbs.

**DIMENSIONS:**\* 17.9" x 5.9" x 9.1"

**COMPATIBLE WITH:** Heavy Duty Safety Switch 100 A/600 V

**CONTROL/POWER SOURCE:**  
RSO-IAR-M18

FOR USE WITH:

**Federal Pacific Electric  
Panelboard Switch**



# RSA-102D

## SPECIFICATIONS

**OPERATION:** Close/Trip

**WEIGHT:** 20.0 lbs.

**DIMENSIONS:**\* 15.6" x 7.4" x 9.2"

**COMPATIBLE WITH:** Heavy Duty Safety Switch 600 A/600 V

**CONTROL/POWER SOURCE:**  
RSO-IAR-M18

FOR USE WITH:

**Federal Pacific Electric  
Panelboard Switch**



\*All unit measurements are L x W x H

# RSA-103

FOR USE WITH:

**Clark/Sylvania/Zinsco/FPE  
Panelboard Switch**

## SPECIFICATIONS

**OPERATION:** Close/Trip

**WEIGHT:** 17.0 lbs.

**DIMENSIONS:**\* 8.6" x 17.8" x 8.3"

**COMPATIBLE WITH:** QSF Series Panelboard Switch (100-600 A, Single, Approximately 90° of Travel)

**CONTROL/POWER SOURCE:**  
RSO-IAR-M18



# RSA-103A

FOR USE WITH:

**Clark/Sylvania/Zinsco/FPE  
Panelboard Switch**

## SPECIFICATIONS

**OPERATION:** Close/Trip

**WEIGHT:** 7.2 lbs.

**DIMENSIONS:**\* 8.6" x 4.0" x 6.3"

**COMPATIBLE WITH:** QSF Series Panelboard Switch (30-100 A, Twin, Approximately 30° of Travel); 5310, 5320, 5325 Motor Control Center (MCC) Bucket (Size 1-4, Approximately 30° of Travel)

**CONTROL/POWER SOURCE:** RSO-IAR-M18

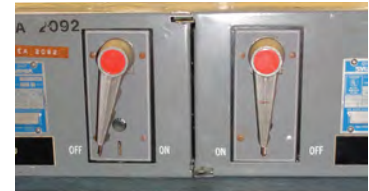

# RSA-104

FOR USE WITH:

**Westinghouse  
Air Circuit Breaker**

## SPECIFICATIONS

**OPERATION:** Charge/Close/Trip

**WEIGHT:** 17.8 lbs.

**DIMENSIONS:**\* 18.2" x 7.9" x 11.2"

**COMPATIBLE WITH:** Type DA-50

**CONTROL/POWER SOURCE:**  
RSO-IIID-M18



\*All unit measurements are L x W x H

# RSA-105

FOR USE WITH:

**Allis-Chalmers/Siemens-Allis/Siemens  
Air Circuit Breaker**

## SPECIFICATIONS

**OPERATION:** Charge/Close/Trip

**WEIGHT:** 37.5 lbs.

**DIMENSIONS:\*** 19.8" x 15.2" x 15.4"

**COMPATIBLE WITH:** Type LA, LAF 1600-2000 A (Yellow Zinc or Gray Plastic Face, Manually Operated, includes LA, LAF-1600, 1600A, 1600AF, 1600B, 2000, 2000A)

**CONTROL/POWER SOURCE:**  
RSO-IIID-M18

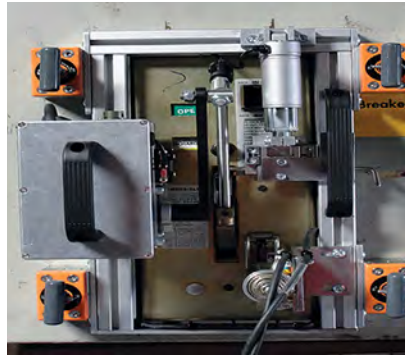

# RSA-105A

FOR USE WITH:

**Allis-Chalmers/Siemens-Allis/Siemens  
Air Circuit Breaker**  
*(Charge Assembly)*

## SPECIFICATIONS

**OPERATION:** Charge

**WEIGHT:** 30.8 lbs.

**DIMENSIONS:\*** 20.4" x 13.4" x 10.1"

**COMPATIBLE WITH:** Type LA, LAF 3000-4000 A (Yellow Zinc Face, Manually Operated, includes LA, LAF-3000, 3000A, 3200, 3200A, 4000, 4000A, 4000B, 4000F) Charge Assembly

**CONTROL/POWER SOURCE:**  
RSO-IIID-M18



# RSA-105A

FOR USE WITH:

**Allis-Chalmers/Siemens-Allis/Siemens  
Air Circuit Breaker**  
*(Close/Trip Assembly)*

## SPECIFICATIONS

**OPERATION:** Close/Trip

**WEIGHT:** 14.5 lbs.

**DIMENSIONS:\*** 23.0" x 7.3" x 6.5"

**COMPATIBLE WITH:** Type LA, LAF 3000-4000 A (Yellow Zinc Face, Manually Operated, includes LA, LAF-3000, 3000A, 3200, 3200A, 4000, 4000A, 4000B, 4000F) Close/Trip Assembly

**CONTROL/POWER SOURCE:**  
RSO-IIID-M18

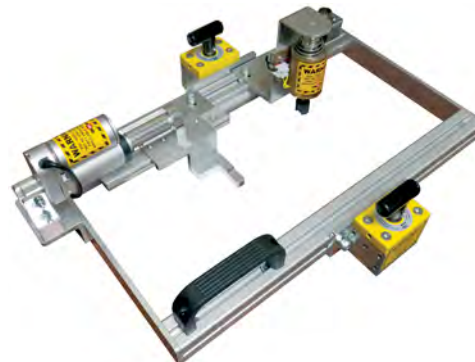

\*All unit measurements are L x W x H

# RSA-105B

FOR USE WITH:

**Allis-Chalmers/Siemens-Allis/Siemens  
Air Circuit Breaker**

## SPECIFICATIONS

**OPERATION:** Charge/Close/Trip

**WEIGHT:** 36.6 lbs.

**DIMENSIONS:**\* 19.1" x 14.4" x 12.1"

**COMPATIBLE WITH:** Type LA, LAF 600-800 A (Yellow Zinc or Gray Plastic Face, Manually Operated, includes LA, LAF-600A, 600AF, 600B, 600F, 800, 800A, 800B)

**CONTROL/POWER SOURCE:**  
RSO-IIID-M18



# RSA-105C

FOR USE WITH:

**Allis-Chalmers/Siemens-Allis/Siemens  
Air Circuit Breaker**

## SPECIFICATIONS

**OPERATION:** Close/Trip

**WEIGHT:** 14.5 lbs.

**DIMENSIONS:**\* 23.0" x 7.3" x 6.5"

**COMPATIBLE WITH:** Type LA, LAF 3000-4000 A (Yellow Zinc Face, Manually or Electrically Operated, includes LA, LAF-3000A, 3200, 3200A, 4000A, 4000B, 4000F)

**CONTROL/POWER SOURCE:**  
RSO-IIID-M18



# RSA-105D

FOR USE WITH:

**Allis-Chalmers/Siemens-Allis/Siemens  
Air Circuit Breaker**

## SPECIFICATIONS

**OPERATION:** Close/Trip

**WEIGHT:** 18.0 lbs.

**DIMENSIONS:**\* 16.8" x 11.2" x 6.5"

**COMPATIBLE WITH:** Type LA, LAF 3000 A (Electrically Operated with Racking Mechanism in Top Center)

**CONTROL/POWER SOURCE:**  
RSO-IIID-M18

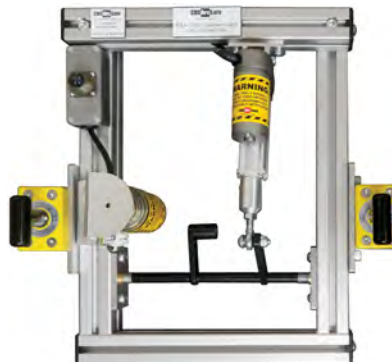

\*All unit measurements are L x W x H

# RSA-105E

FOR USE WITH:

**Allis-Chalmers/Siemens-Allis/Siemens  
Air Circuit Breaker**



## SPECIFICATIONS

OPERATION: Close/Trip

WEIGHT: 17.0 lbs.

DIMENSIONS:\* 19.5" x 15.3" x 7.4"

COMPATIBLE WITH: Type LA, LAF  
1600-2000 A (Manually Operated)

CONTROL/POWER SOURCE:  
RSO-IIID-M18



# RSA-105F

FOR USE WITH:

**Allis-Chalmers/Siemens-Allis/Siemens  
Air Circuit Breaker**

## SPECIFICATIONS

OPERATION: Close/Trip

WEIGHT: 36.7 lbs.

DIMENSIONS:\* 19.1" x 14.4" x 12.1"

COMPATIBLE WITH: Type LA, LAF  
600-800 A (Yellow Zinc Face, Manually  
Operated, includes LA, LAF-600A,  
600AF, 600B, 600F, 800, 800A)

CONTROL/POWER SOURCE:  
RSO-IIID-M18



# RSA-107

FOR USE WITH:

**Elliot Control  
Motor Control Center**

## SPECIFICATIONS

OPERATION: Close/Trip

WEIGHT: 16.3 lbs.

DIMENSIONS:\* 29.9" x 4.1" x 8.7"

COMPATIBLE WITH: Type 230

CONTROL/POWER SOURCE:  
RSO-IAR-M18



\*All unit measurements are L x W x H

# RSA-108

FOR USE WITH:

**Elliot Control  
Motor Control Center**



## SPECIFICATIONS

OPERATION: Close/Trip

WEIGHT: 20.0 lbs.

DIMENSIONS:\* 23.0" x 6.0" x 8.0"

COMPATIBLE WITH: Type 211 MVMCC Isolation Switch Only, Not Compatible with Series 230 or 230-PM

CONTROL/POWER SOURCE: RSO-IAR-M18



# RSA-111E

FOR USE WITH:

**ABB  
Molded Case Circuit Breaker**

## SPECIFICATIONS

OPERATION: Close/Trip

WEIGHT: 10.3 lbs.

DIMENSIONS:\* 11.9" x 9.3" x 5.5"

COMPATIBLE WITH: N Frame MCCB 1200 A Frame (includes NSB, NHB)

CONTROL/POWER SOURCE: RSO-IAR-M18

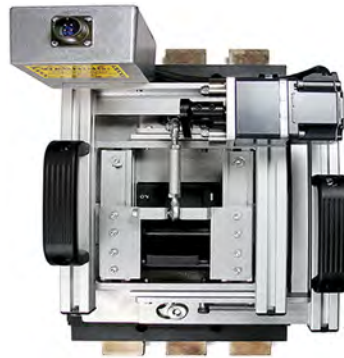

# RSA-111F

FOR USE WITH:

**ABB  
Molded Case Circuit Breaker**

## SPECIFICATIONS

OPERATION: Close/Trip

WEIGHT: 8.6 lbs.

DIMENSIONS:\* 15.5" x 11.5" x 7.5"

COMPATIBLE WITH: P Frame MCCB 1600, 2000, 2500 A Frame (includes PSB)

CONTROL/POWER SOURCE: RSO-IAR-M18



\*All unit measurements are L x W x H

# RSA-112

FOR USE WITH:  
**Federal Pacific Electric  
Air Circuit Breaker**

## SPECIFICATIONS

**OPERATION:** Charge/Close/Trip

**WEIGHT:** 32.1 lbs.

**DIMENSIONS:**\* 18.6" x 12.3" x 10.9"

**COMPATIBLE WITH:** Type H-2, HL-2, Manually Operated, 600-6000 A (includes 25, 35, 50, 65, 75, 100 H, HL-2) & Type H-3, HL-3, Manually Operated 600-4000 A (includes 30, 42, 50, 65, 75, 100 H, HL-3)

**CONTROL/POWER SOURCE:** RSO-IIID-M18



# RSA-112B

FOR USE WITH:  
**Federal Pacific Electric  
Air Circuit Breaker**

## SPECIFICATIONS

**OPERATION:** Close/Trip

**WEIGHT:** 12.2 lbs.

**DIMENSIONS:**\* 12.2" x 12.6" x 6.3"

**COMPATIBLE WITH:** Type H-2, HL-2, Electrically Operated, 600-6000 A (includes 25, 35, 50, 65, 75, 100 H, HL-2) & Type H-3, HL-3, Electrically Operated 600-4000 A (includes 30, 42, 50, 65, 75, 100 H, HL-3)

**CONTROL/POWER SOURCE:** RSO-IAR-M18



# RSA-113

FOR USE WITH:  
**Cutler-Hammer/Westinghouse  
Molded Case Circuit Breaker**

## SPECIFICATIONS

**OPERATION:** Close/Trip

**WEIGHT:** 11.5 lbs.

**DIMENSIONS:**\* 20.0" x 4.3" x 7.0"

**COMPATIBLE WITH:** Series C MCCB N Frame (includes ND, CND, HND, CHND, CNDC, NDC, HNDC, NDU; Except NS), 400-1200 A, White Molded Case, Flush Mounted with Handle Extension

**CONTROL/POWER SOURCE:** RSO-IAR-M18



\*All unit measurements are L x W x H

# RSA-113A

FOR USE WITH:

**Cutler-Hammer/Westinghouse  
Molded Case Circuit Breaker**

## SPECIFICATIONS

**OPERATION:** Close/Trip

**WEIGHT:** 10.5 lbs.

**DIMENSIONS:**\* 12.3" x 6.1" x 4.6"

**COMPATIBLE WITH:** Series C MCCB K Frame (includes KD, KDB, CKD, HKD, HKDB, CHKD, KDC; Except KS), 70-400 A, White Molded Case, Flush Mounted

**CONTROL/POWER SOURCE:**  
RSO-IAR-M18



# RSA-113B

FOR USE WITH:

**Cutler-Hammer/Westinghouse  
Molded Case Circuit Breaker**

## SPECIFICATIONS

**OPERATION:** Close/Trip

**WEIGHT:** 7.5 lbs.

**DIMENSIONS:**\* 9.0" x 4.6" x 5.6"

**COMPATIBLE WITH:** Series C MCCB F Frame (includes FD, HFD, FDC, FDB, FDE, HFDE, FDCE; Except FS), 10-225 A, White Molded Case, Flush Mounted

**CONTROL/POWER SOURCE:**  
RSO-IAR-M18



# RSA-113D

FOR USE WITH:

**Cutler-Hammer/Westinghouse  
Molded Case Circuit Breaker**

## SPECIFICATIONS

**OPERATION:** Close/Trip

**WEIGHT:** 7.5 lbs.

**DIMENSIONS:**\* 8.0" x 5.7" x 5.5"

**COMPATIBLE WITH:** Series C MCCB J Frame (includes JD, JDB, HJD, JDC; Except JS), 70-250 A, White Molded Case, Flush Mounted

**CONTROL/POWER SOURCE:**  
RSO-IAR-M18



\*All unit measurements are L x W x H

# RSA-113E

FOR USE WITH:

**Cutler-Hammer/Westinghouse  
Molded Case Circuit Breaker**

## SPECIFICATIONS

**OPERATION:** Close/Trip

**WEIGHT:** 12.4 lbs.

**DIMENSIONS:**\* 19.6" x 6.1" x 5.4"

**COMPATIBLE WITH:** Series C MCCB M and L Frames (includes MDL, CMDL, HMDL, CHMDL, HMDLB, LD, LDB, CLD, HLD, CHLD, LDC, CLDC; Except LS and MS), 125-600 A for L Frame and 300-800 A for M Frame, White Molded Case, Flush Mounted, Without Handle Extension. Not for Circuit Breakers Mounted in Enclosures with External Handle Operators.

**CONTROL/POWER SOURCE:** RSO-IAR-M18



# RSA-113G

FOR USE WITH:

**Cutler-Hammer/Westinghouse  
Molded Case Circuit Breaker**

## SPECIFICATIONS

**OPERATION:** Close/Trip

**WEIGHT:** 24.7 lbs.

**DIMENSIONS:**\* 21.3" x 15.8" x 8.0"

**COMPATIBLE WITH:** Series C MCCB R Frame (includes RD, CRD, RDC, CRDC), 800-2500 A, White Molded Case, Flush Mounted with Handle Extension

**CONTROL/POWER SOURCE:**  
RSO-IAR-M18



# RSA-113I

FOR USE WITH:

**Cutler-Hammer/Westinghouse  
Molded Case Circuit Breaker**

## SPECIFICATIONS

**OPERATION:** Close/Trip

**WEIGHT:** 16.2 lbs.

**DIMENSIONS:**\* 15.8" x 6.6" x 5.6"

**COMPATIBLE WITH:** Series C MCCB L Frame (includes LD, LDB, CLD, HLD, CHLD, LDC, CLDC; Except LS), 125-600 A, White Molded Case, Recessed Mounted without Handle Extension

**CONTROL/POWER SOURCE:**  
RSO-IAR-M18



\*All unit measurements are L x W x H

# RSA-113J

FOR USE WITH:

**Cutler-Hammer/Westinghouse  
Molded Case Circuit Breaker**

## SPECIFICATIONS

OPERATION: Close/Trip

WEIGHT: 13.0 lbs.

DIMENSIONS: \* 23.9" x 13.5" x 6.6"

COMPATIBLE WITH: Series C MCCB R Frame (includes RD, CRD, RDC, CRDC), 800-2500 A, White Molded Case, Standalone Mounted with Handle Extension (Requires Additional Hardware Kit)

CONTROL/POWER SOURCE:  
RSO-IAR-M18

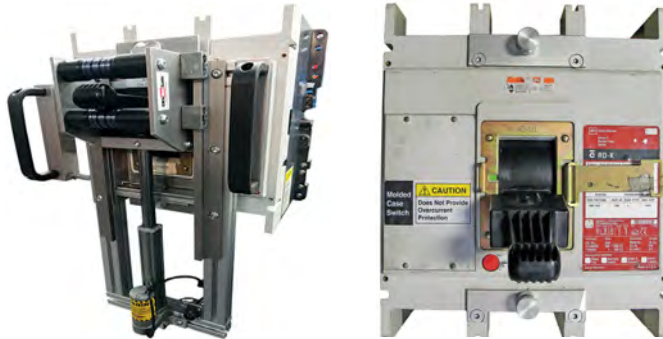

# RSA-114

FOR USE WITH:

**ABB/BBC/ITE  
Air Circuit Breaker**

## SPECIFICATIONS

OPERATION: Charge/Close/Trip

WEIGHT: 22.0 lbs.

DIMENSIONS: \* 7.1" x 9.4" x 13.5"

COMPATIBLE WITH: Type LK (includes LK, LKD, LKE-8, 16, 20, 25, 32, 40, 42)

CONTROL/POWER SOURCE:  
RSO-IIID-M18



# RSA-114A

FOR USE WITH:

**ABB/BBC/ITE  
Air Circuit Breaker**

## SPECIFICATIONS

OPERATION: Close/Trip

WEIGHT: 10.0 lbs.

DIMENSIONS: \* 9.6" x 6.0" x 5.0"

COMPATIBLE WITH: Type LK All Sizes

CONTROL/POWER SOURCE:  
RSO-IIID-M18



\*All unit measurements are L x W x H

# RSA-115

FOR USE WITH:  
**ABB/BBC/ITE**  
**Air Circuit Breaker**

## SPECIFICATIONS

**OPERATION:** Charge/Close/Trip

**WEIGHT:** 20.4 lbs.

**DIMENSIONS:**\* 15.6" x 11.8" x 5.8"

**COMPATIBLE WITH:** Type MB  
(includes MB, MBE, MBD, MBK-8, 16, 20, 25, 32, 40, 42, Door Open)

**CONTROL/POWER SOURCE:**  
RSO-IIID-M18



# RSA-115A

FOR USE WITH:  
**ABB/BBC/ITE**  
**Air Circuit Breaker**



## SPECIFICATIONS

**OPERATION:** Charge/Close/Trip

**WEIGHT:** 30.0 lbs.

**DIMENSIONS:**\* 19.7" x 16.7" x 12.0"

**COMPATIBLE WITH:** Type MBE  
(includes MB, MBE, MBD, MBK-8, 16, 20, 25, 32, 40, 42, Door Closed),  
Recessed Variant

**CONTROL/POWER SOURCE:**  
RSO-IIID-M18



# RSA-116

FOR USE WITH:  
**S&C**  
**Load Interrupter Switch**

## SPECIFICATIONS

**OPERATION:** Close/Trip

**WEIGHT:** 36.5 lbs.

**DIMENSIONS:**\* 28.5" x 19.6" x 7.6"

**COMPATIBLE WITH:** Load Break  
Switch with Protruding Handle  
Operator

**CONTROL/POWER SOURCE:**  
RSO-IAR-M18



\*All unit measurements are L x W x H

# RSA-116A

FOR USE WITH:

**S&C**  
**Load Interrupter Switch**

## SPECIFICATIONS

OPERATION: Close/Trip

WEIGHT: 23.2 lbs.

DIMENSIONS:\* 24.5" x 11.5" x 7.0"

COMPATIBLE WITH: Load Break Switch with Recessed Handle Operator

CONTROL/POWER SOURCE:  
RSO-IAR-M18

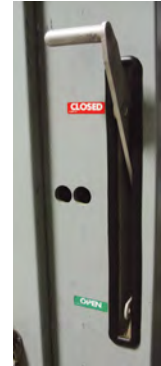

# RSA-116C

FOR USE WITH:

**S&C**  
**Load Interrupter Switch**

## SPECIFICATIONS

OPERATION: Close/Trip

WEIGHT: 42.1 lbs.

DIMENSIONS:\* 29.5" x 12.0" x 9.1"

COMPATIBLE WITH: Load Break Switch with Non-Standard Enclosure

CONTROL/POWER SOURCE:  
RSO-IAR-M18



# RSA-116D

FOR USE WITH:

**S&C**  
**Load Interrupter Switch**

## SPECIFICATIONS

OPERATION: Close/Trip

WEIGHT: 29.3 lbs.

DIMENSIONS:\* 26.0" x 17.2" x 6.0"

COMPATIBLE WITH: Load Break Switch, Flush Mounted

CONTROL/POWER SOURCE:  
RSO-IAR-M18

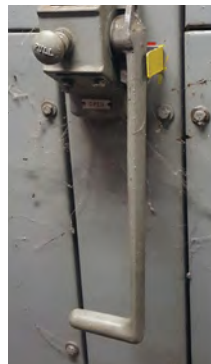

\*All unit measurements are L x W x H

# RSA-116E

FOR USE WITH:

**S&C**  
**Load Interrupter Switch**

## SPECIFICATIONS

**OPERATION:** Close/Trip

**WEIGHT:** 28.3 lbs.

**DIMENSIONS:\*** 25.4" x 14.4" x 6.0"

**COMPATIBLE WITH:** Load Break Switch, Flush Application with 13.5" Handle Overall

**CONTROL/POWER SOURCE:**  
RSO-IAR-M18



# RSA-117

FOR USE WITH:

**Westinghouse**  
**Load Break Switch**

## SPECIFICATIONS

**OPERATION:** Close/Trip

**WEIGHT:** 42.3 lbs.

**DIMENSIONS:\*** 34.6" x 10.7" x 10.1"

**COMPATIBLE WITH:** Type WLI Load Interrupter Switch

**CONTROL/POWER SOURCE:**  
RSO-IAR-M18



# RSA-117A

FOR USE WITH:

**Cutler-Hammer**  
**Load Break Switch**

## SPECIFICATIONS

**OPERATION:** Close/Trip

**WEIGHT:** 39.6 lbs.

**DIMENSIONS:\*** 36.4" x 9.9" x 7.5"

**COMPATIBLE WITH:** MVS Load Break Switch

**CONTROL/POWER SOURCE:**  
RSO-IAR-M18



\*All unit measurements are L x W x H

# RSA-117B

FOR USE WITH:

**Eaton**  
**Load Break Switch**

## SPECIFICATIONS

OPERATION: Close/Trip

WEIGHT: 33.1 lbs.

DIMENSIONS:\* 32.6" x 13.0" x 6.6"

COMPATIBLE WITH: Type LBS Load Break Switch

CONTROL/POWER SOURCE:  
RSO-IAR-M18



# RSA-117D

FOR USE WITH:

**Westinghouse**  
**Load Interrupter Switch**

## SPECIFICATIONS

OPERATION: Close/Trip

WEIGHT: 44.1 lbs.

DIMENSIONS:\* 44.4" x 11.7" x 10.4"

COMPATIBLE WITH: Type WLI Load Break Switch with Permanent Handle

CONTROL/POWER SOURCE:  
RSO-IAR-M18



# RSA-119

FOR USE WITH:

**Merlin Gerin**  
**Insulated Case Circuit Breaker**

## SPECIFICATIONS

OPERATION: Charge/Close/Trip

WEIGHT: 37.0 lbs.

DIMENSIONS:\* 5.5" x 19.5" x 19.0"

COMPATIBLE WITH: Type MP - All (Door Closed)

CONTROL/POWER SOURCE:  
RSO-IIID-M18

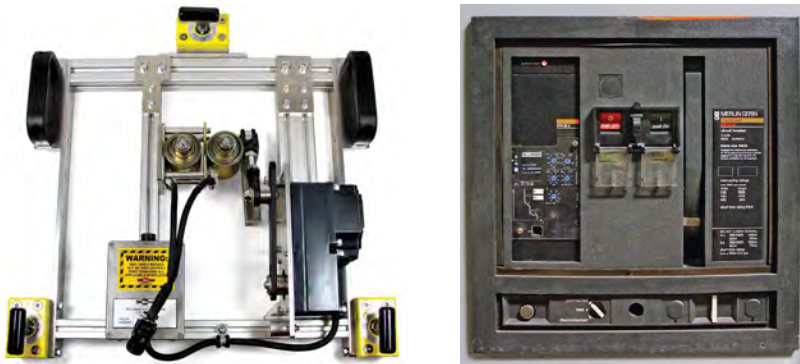

\*All unit measurements are L x W x H

# RSA-119A

FOR USE WITH:

**Merlin Gerin  
Insulated Case Circuit Breaker**

## SPECIFICATIONS

**OPERATION:** Close/Trip

**WEIGHT:** 29.1 lbs.

**DIMENSIONS:**\* 5.5" x 19.5" x 6.5"

**COMPATIBLE WITH:** Type MP - All  
(Door Closed)

**CONTROL/POWER SOURCE:**  
RSO-IIID-M18



# RSA-119B

FOR USE WITH:

**Merlin Gerin  
Insulated Case Circuit Breaker**

## SPECIFICATIONS

**OPERATION:** Charge/Close/Trip

**WEIGHT:** 35.3 lbs.

**DIMENSIONS:**\* 17.9" x 16.3" x 6.3"

**COMPATIBLE WITH:** Type MP - All  
(Door Open)

**CONTROL/POWER SOURCE:**  
RSO-IIID-M18



# RSA-120

FOR USE WITH:

**Schneider Electric/Square D  
Insulated Case Circuit Breaker**



## SPECIFICATIONS

**OPERATION:** Charge/Close/Trip

**WEIGHT:** 24.0 lbs.

**DIMENSIONS:**\* 4.8" x 19.4" x 18.8"

**COMPATIBLE WITH:** Masterpact NW -  
All (Door Closed)

**CONTROL/POWER SOURCE:**  
RSO-IIID-M18



\*All unit measurements are L x W x H

# RSA-120A

FOR USE WITH:

**Schneider Electric/Square D  
Insulated Case Circuit Breaker**



## SPECIFICATIONS

OPERATION: Close/Trip

WEIGHT: 15.0 lbs.

DIMENSIONS:\* 16.0" x 19.4" x 6.4"

COMPATIBLE WITH: Masterpact NW - All

CONTROL/POWER SOURCE:

RSO-IIID-M18



# RSA-120B

FOR USE WITH:

**Schneider Electric/Square D  
Insulated Case Circuit Breaker**

## SPECIFICATIONS

OPERATION: Charge/Close/Trip

WEIGHT: 36.5 lbs.

DIMENSIONS:\* 17.9" x 16.3" x 19.0"

COMPATIBLE WITH: Masterpact NW -  
All (Door Open)

CONTROL/POWER SOURCE:

RSO-IIID-M18



# RSA-123

FOR USE WITH:

**Square D  
Panelboard Switch**

## SPECIFICATIONS

OPERATION: Close/Trip

WEIGHT: 15.7 lbs.

DIMENSIONS:\* 13.8" x 5.8" x 12.1"

COMPATIBLE WITH: Type QMBW  
- QMB224W, 324W, 264W, 364W;  
QMJ365 (9" Single Switch)

CONTROL/POWER SOURCE:

RSO-IAR-M18



\*All unit measurements are L x W x H

# RSA-123A

FOR USE WITH:

**Square D  
Panelboard Switch**

## SPECIFICATIONS

**OPERATION:** Close/Trip

**WEIGHT:** 12.7 lbs.

**DIMENSIONS:**\* 6.3" x 8.1" x 9.0"

**COMPATIBLE WITH:** Type QMBW - QMB221TW, 222TW, 223TW, 321TW, 322TW, 323TW, 261TW, 262TW, 263TW, 361TW, 362TW, 363TW; QMJ361T, 362T, 363T, 364T (4.5", 6", 7.5" Twin Switch)

**CONTROL/POWER SOURCE:**  
RSO-IAR-M18



# RSA-123C

FOR USE WITH:

**Square D  
Panelboard Switch**

## SPECIFICATIONS

**OPERATION:** Close/Trip

**WEIGHT:** 15.0 lbs.

**DIMENSIONS:**\* 16.3" x 6.6" x 5.2"

**COMPATIBLE WITH:** Type QMBW - QMB225W, 325W, 326W, 365W, 366W, 367W, 368W; QMJ366 (15" Single Switch)

**CONTROL/POWER SOURCE:**  
RSO-IAR-M18



# RSA-124

FOR USE WITH:

**Terasaki  
Molded Case Circuit Breaker**

## SPECIFICATIONS

**OPERATION:** Close/Trip

**WEIGHT:** 11.7 lbs.

**DIMENSIONS:**\* 19.1" x 4.9" x 4.4"

**COMPATIBLE WITH:** Type S400-PE

**CONTROL/POWER SOURCE:**  
RSO-IAR-M18



\*All unit measurements are L x W x H

# RSA-126

FOR USE WITH:

**Federal Pacific Electric  
Air Circuit Breaker**

## SPECIFICATIONS

OPERATION: Trip Only

WEIGHT: 9.4 lbs.

DIMENSIONS: \* 8.4" x 8.5" x 7.6"

COMPATIBLE WITH: Type DST-2

CONTROL/POWER SOURCE:  
RSO-IAR-M18



# RSA-127

FOR USE WITH:

**General Electric  
Panelboard Switch**

## SPECIFICATIONS

OPERATION: Close/Trip

WEIGHT: 8.2 lbs.

DIMENSIONS: \* 7.6" x 6.1" x 7.2"

COMPATIBLE WITH: Type QMR, THFP  
240, 600 V 30, 60, 100 A Twin (Gray  
Metal Handle, includes QMR, THFP221,  
222, 223, 321, 322, 323, 261, 262, 263,  
361, 362, 363)

CONTROL/POWER SOURCE:  
RSO-IAR-M18



# RSA-127B

FOR USE WITH:

**General Electric  
Panelboard Switch**

## SPECIFICATIONS

OPERATION: Close/Trip

WEIGHT: 19.6 lbs.

DIMENSIONS: \* 18.3" x 9.1" x 9.8"

COMPATIBLE WITH: Type QMR, THFP  
240, 600 V 400, 600 A (Gray Metal  
Handle, includes QMR, THFP225, 226,  
325, 326, 365, 366)

CONTROL/POWER SOURCE:  
RSO-IAR-M18



\*All unit measurements are L x W x H

# RSA-127C

FOR USE WITH:  
**General Electric  
Panelboard Switch**

## SPECIFICATIONS

**OPERATION:** Close/Trip

**WEIGHT:** 27.2 lbs.

**DIMENSIONS:**\* 20.3" x 14.5" x 10.8"

**COMPATIBLE WITH:** Type QMR, THFP 240, 600 V 800, 1200 A (Black Plastic Handle, includes QMR, THFP367, 368)

**CONTROL/POWER SOURCE:**  
RSO-IAR-M18



# RSA-132A

FOR USE WITH:  
**Federal Pacific Electric  
Load Interrupter Switch**



## SPECIFICATIONS

**OPERATION:** Close/Trip

**WEIGHT:** 40.0 lbs.

**DIMENSIONS:**\* 38.7" x 10.0" x 12.4"

**COMPATIBLE WITH:** Autojet LIS 5-38 kV

**CONTROL/POWER SOURCE:**  
RSO-IAR-M18



# RSA-134

FOR USE WITH:  
**Square D  
Panelboard Switch**

## SPECIFICATIONS

**OPERATION:** Close/Trip

**WEIGHT:** 4.6 lbs.

**DIMENSIONS:**\* 7.0" x 5.8" x 4.2"

**COMPATIBLE WITH:** Type QMB Saflex Panelboard Switch 6.0" Twin 30 A & 60 A Series 2 or 4 (includes QMB3203T, QMB3206T, QMB3603T, QMB3606T) & 7.5" Twin 60 A & 100 A Series 2 or 4 (includes QMB3206T, QMB3210T, QMB3606T, QMB3610T)

**CONTROL/POWER SOURCE:** RSO-IAR-M18



\*All unit measurements are L x W x H

# RSA-134B

FOR USE WITH:  
**Square D  
Panelboard Switch**

## SPECIFICATIONS

**OPERATION:** Close/Trip

**WEIGHT:** 17.3 lbs.

**DIMENSIONS:**\* 10.6" x 17.5" x 8.6"

**COMPATIBLE WITH:** Type QMB Saflex Panelboard Switch 12.0", 15.0", 18.0" Single 400 A & 600 A Series 1 or 4 (includes QMB3240, QMB3240M, QMB3260, QMB3260M, QMB3640, QMB3640M, QMB3660, QMB3660M)

**CONTROL/POWER SOURCE:**  
RSO-IAR-M18



# RSA-134H

FOR USE WITH:  
**Square D  
Panelboard Switch**

## SPECIFICATIONS

**OPERATION:** Close/Trip

**WEIGHT:** 24 lbs.

**DIMENSIONS:**\* 9.8" x 9.1" x 16.6"

**COMPATIBLE WITH:** Type QMB Saflex Panelboard Switch, 2000 A

**CONTROL/POWER SOURCE:**  
RSO-IAR-M18

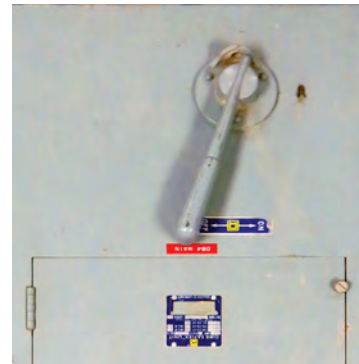

# RSA-135

FOR USE WITH:  
**Eaton/Cutler-Hammer/Pringle  
Bolted Pressure Switch**

## SPECIFICATIONS

**OPERATION:** Close/Trip

**WEIGHT:** 39.2 lbs.

**DIMENSIONS:**\* 20.6" x 20.8" x 12.2"

**COMPATIBLE WITH:** Pringle Switch QA-CBC: 2500 A & below (includes 800, 1200, 1600, 2000, & 2500 A), Current Vintage, Straight Handle (Black or Bare Aluminum) Only, with Shunt Trip, 90° of Handle Travel, 28-32" Min. Cubicle Width

**CONTROL/POWER SOURCE:** RSO-IIID-M18



\*All unit measurements are L x W x H

# RSA-135A

FOR USE WITH:

**Eaton/Cutler-Hammer/Pringle  
Bolted Pressure Switch**

## SPECIFICATIONS

**OPERATION:** Close/Trip

**WEIGHT:** 36.0 lbs.

**DIMENSIONS:**\* 11.0" x 29.0" x 20.0"

**COMPATIBLE WITH:** Pringle Switch QA-CBC above 2500 A (includes 3000 & 4000 A); Current Vintage; Straight Handle (Black or Bare Aluminum) Only, with Shunt Trip, 90° of Handle Travel, 44" Min. Cubicle Width

**CONTROL/POWER SOURCE:**  
RSO-IIID-M18



# RSA-135D

FOR USE WITH:

**Eaton/Cutler-Hammer/Pringle  
Bolted Pressure Switch**

## SPECIFICATIONS

**OPERATION:** Close/Trip

**WEIGHT:** 37.3 lbs.

**DIMENSIONS:**\* 20.8" x 21.8" x 11.4"

**COMPATIBLE WITH:** Pringle Switch QA 800 A Only; Current Vintage; Straight Handle (Black or Bare Aluminum) Only, without Shunt Trip, 90° of Handle Travel, 24" Min. Cubicle Width

**CONTROL/POWER SOURCE:** RSO-IAR-M18

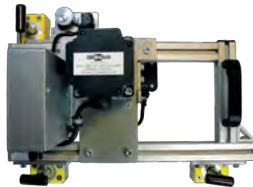

# RSA-135E

FOR USE WITH:

**Eaton/Cutler-Hammer/Pringle  
Bolted Pressure Switch**

## SPECIFICATIONS

**OPERATION:** Close/Trip

**WEIGHT:** 36.7 lbs.

**DIMENSIONS:**\* 20.0" x 24.2" x 11.4"

**COMPATIBLE WITH:** Pringle Switch QA 1200-2500 A (includes 1200, 1600, 2000, 2500 A); Current Vintage; Straight Handle (Black or Bare Aluminum) Only, without Shunt Trip, 115° of Handle Travel, 28-32" Min. Cubicle Width

**CONTROL/POWER SOURCE:**  
RSO-IAR-M18



\*All unit measurements are L x W x H

# RSA-135F

FOR USE WITH:

**Eaton/Cutler-Hammer/Pringle  
Bolted Pressure Switch**

## SPECIFICATIONS

**OPERATION:** Close/Trip

**WEIGHT:** 35.9 lbs.

**DIMENSIONS:**\* 20.0" x 24.8" x 10.9"

**COMPATIBLE WITH:** Pringle Switch QA above 2500 A (includes 3000 & 4000 A); Current Vintage; Straight Handle (Black or Bare Aluminum) Only, without Shunt Trip, 115° of Handle Travel, 44" Min. Cubicle Width

**CONTROL/POWER SOURCE:** RSO-IAR-M18



# RSA-135G

FOR USE WITH:

**Eaton/Cutler-Hammer/Pringle  
Bolted Pressure Switch**

## SPECIFICATIONS

**OPERATION:** Close/Trip

**WEIGHT:** 36.8 lbs.

**DIMENSIONS:**\* 26.0" x 20.3" x 11.2"

**COMPATIBLE WITH:** Pringle Switch QA 800 A Only; Legacy Vintage; Straight Cast Aluminum (Black or Bare Aluminum) Only, without Shunt Trip, 90° of Handle Travel, 24" Min. Cubicle Width

**CONTROL/POWER SOURCE:** RSO-IAR-M18



# RSA-135H

FOR USE WITH:

**Eaton/Cutler-Hammer/Pringle  
Bolted Pressure Switch**

## SPECIFICATIONS

**OPERATION:** Close/Trip

**WEIGHT:** 35.4 lbs.

**DIMENSIONS:**\* 20.0" x 22.8" x 10.9"

**COMPATIBLE WITH:** Pringle Switch QA 1200-2500 A (includes 1200, 1600, 2000, 2500 A); Legacy Vintage ; Straight Cast Aluminum (Black or Bare Aluminum) Only, without Shunt Trip, 115° of Handle Travel, 28-32" Min. Cubicle Width

**CONTROL/POWER SOURCE:** RSO-IAR-M18

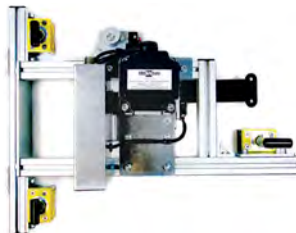

\*All unit measurements are L x W x H

# RSA-135I

FOR USE WITH:

**Eaton/Cutler-Hammer/Pringle  
Bolted Pressure Switch**

## SPECIFICATIONS

**OPERATION:** Close/Trip

**WEIGHT:** 35.3 lbs.

**DIMENSIONS:**\* 20.0" x 24.8" x 10.9"

**COMPATIBLE WITH:** Pringle Switch QA above 2500 A (includes 3000 & 4000 A); Legacy Vintage; Straight Cast Aluminum (Black or Bare Aluminum) Only, without Shunt Trip, 115° of Handle Travel, 44" Min. Cubicle Width

**CONTROL/POWER SOURCE:** RSO-IAR-M18

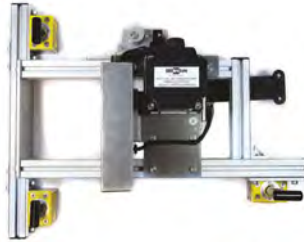

# RSA-136

FOR USE WITH:

**ITE/Siemens  
Molded Case Circuit Breaker**

## SPECIFICATIONS

**OPERATION:** Close/Trip

**WEIGHT:** 19.5 lbs.

**DIMENSIONS:**\* 16.1" x 9.4" x 6.4"

**COMPATIBLE WITH:** Sentron Series JD, HJD, HHJD, CJD, JXD, HJXD, HHJXD, CJXD (200-400 A), LD, HLD, HHL, CLD, LX, HLXD, HHLXD, CLXD (250-600 A)

**CONTROL/POWER SOURCE:** RSO-IAR-M18



# RSA-136A

FOR USE WITH:

**ITE/Siemens  
Molded Case Circuit Breaker**

## SPECIFICATIONS

**OPERATION:** Close/Trip

**WEIGHT:** 7.4 lbs.

**DIMENSIONS:**\* 8.0" x 5.7" x 5.4"

**COMPATIBLE WITH:** Sentron Series ED, HED, CED (15-125 A)

**CONTROL/POWER SOURCE:** RSO-IAR-M18



\*All unit measurements are L x W x H

# RSA-136B

FOR USE WITH:  
**ITE/Siemens**  
**Molded Case Circuit Breaker**

## SPECIFICATIONS

OPERATION: Close/Trip

WEIGHT: 20.0 lbs.

DIMENSIONS: \* 18.5" x 11.3" x 8.3"

COMPATIBLE WITH: Sentron Series LMD, HLMD, LMXD, HLMXD, MD, HMD, CMD, MXD, HMXD, CMXD (500-800 A), ND, HND, CND, NXD, HNXD, CNXD (800-1200 A), PD, HPD, CPD, PXD, HPXD, CPXD (1200-1600 A), RD, HRD, RXD, HRXD (1600-2000 A)

CONTROL/POWER SOURCE: RSO-IAR-M18

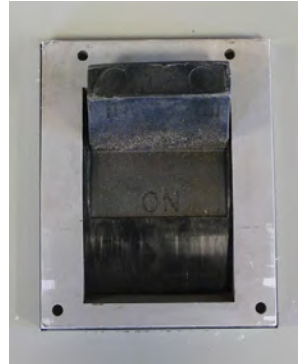

# RSA-136C

FOR USE WITH:  
**ITE/Siemens**  
**Molded Case Circuit Breaker**

## SPECIFICATIONS

OPERATION: Close/Trip

WEIGHT: 10.8 lbs.

DIMENSIONS: \* 15.6" x 4.5" x 5.1"

COMPATIBLE WITH: Sentron Series FD, HFD, HHFD, CFD, FXD, HFXD, HHFXD, CFXD (70-250 A)

CONTROL/POWER SOURCE: RSO-IAR-M18



# RSA-136D

FOR USE WITH:  
**ITE/Siemens**  
**Molded Case Circuit Breaker**

## SPECIFICATIONS

OPERATION: Close/Trip

WEIGHT: 29.7 lbs.

DIMENSIONS: \* 20.8" x 13.6" x 8.4"

COMPATIBLE WITH: Sentron Series TD, HTD, HHTD, STD, SHTD, SHHTD (2000-3200 A)

CONTROL/POWER SOURCE: RSO-IAR-M18



\*All unit measurements are L x W x H

# RSA-136E

FOR USE WITH:

**ITE/Siemens  
Molded Case Circuit Breaker**

## SPECIFICATIONS

**OPERATION:** Close/Trip

**WEIGHT:** 19.2 lbs.

**DIMENSIONS:\*** 17.6" x 11.8" x 5.3"

**COMPATIBLE WITH:** Sentron Series LMD, MD (500-800 A), ND (800-1200 A), PD (1200-1600 A), RD (1600-2000 A) with Handle Extension

**CONTROL/POWER SOURCE:**  
RSO-IAR-M18

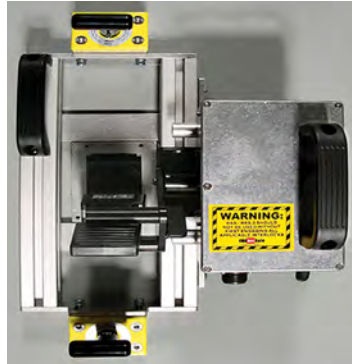

# RSA-138

FOR USE WITH:

**Allis-Chalmers/Siemens-Allis  
Load Interrupter Switch**

## SPECIFICATIONS

**OPERATION:** Close/Trip

**WEIGHT:** 19.0 lbs.

**DIMENSIONS:\*** 20.1" x 5.3" x 11.6"

**COMPATIBLE WITH:** Type LBS-SE

**CONTROL/POWER SOURCE:**  
RSO-IAR-M18



# RSA-138A

FOR USE WITH:

**Allis-Chalmers/Siemens-Allis  
Load Interrupter Switch**

## SPECIFICATIONS

**OPERATION:** Close/Trip

**WEIGHT:** 18.6 lbs.

**DIMENSIONS:\*** 28.1 x 10.0 x 10.8"

**COMPATIBLE WITH:** Type LBS-SE2, SG 3328, or QB (with Type SE2A Operator) 5, 15 kV Metal Enclosed Load Interrupter Switch

**CONTROL/POWER SOURCE:**  
RSO-IAR-M18



\*All unit measurements are L x W x H

# RSA-138B

FOR USE WITH:

**Allis-Chalmers/Siemens-Allis  
Load Interrupter Switch**

## SPECIFICATIONS

**OPERATION:** Close/Trip

**WEIGHT:** 20.9 lbs.

**DIMENSIONS:**\* 26.4" x 9.2" x 9.4"

**COMPATIBLE WITH:** Type LBS-SE4 or QB  
(with Type SE4 Operator) 5, 15 kV Metal  
Enclosed Load Interrupter Switch

**CONTROL/POWER SOURCE:**  
RSO-IAR-M18



# RSA-139

FOR USE WITH:

**Allis-Chalmers/Siemens-Allis/Siemens  
Load Interrupter Switch**

## SPECIFICATIONS

**OPERATION:** Close/Trip

**WEIGHT:** 28.3 lbs.

**DIMENSIONS:**\* 27.1" x 8.3" x 11.4"

**COMPATIBLE WITH:** Spacemaker,  
Spacemaker II, Type 456 Contactor

**CONTROL/POWER SOURCE:**  
RSO-IAR-M18



# RSA-140

FOR USE WITH:

**Klockner Moeller/Moeller Electric  
Motor Control Center**

## SPECIFICATIONS

**OPERATION:** Close/Trip

**WEIGHT:** 26.5 lbs.

**DIMENSIONS:**\* 10.1" x 10.9" x 7.6"

**COMPATIBLE WITH:** Type IVS,  
Modan 2000, Modan 3000 MCC  
Handle Operator (Small)

**CONTROL/POWER SOURCE:**  
RSO-IAR-M18



\*All unit measurements are L x W x H

# RSA-140B

FOR USE WITH:

**Klockner Moeller/Moeller Electric  
Motor Control Center**

## SPECIFICATIONS

**OPERATION:** Close/Trip

**WEIGHT:** 22.5 lbs.

**DIMENSIONS:\*** 17.0" x 10.8" x 9.6"

**COMPATIBLE WITH:** Type IVS, Modan 2000, Modan 3000 MCC Handle Operator (Large)

**CONTROL/POWER SOURCE:**  
RSO-IAR-M18



# RSA-145E

FOR USE WITH:

**ABB/SACE  
Molded Case Circuit Breaker**

## SPECIFICATIONS

**OPERATION:** Close/Trip

**WEIGHT:** 8.4 lbs.

**DIMENSIONS:\*** 4.7" x 7.9" x 8.3"

**COMPATIBLE WITH:** Isomax MCCB Size S7 1200 A Frame (Breaker Recessed Into Cabinet, Actuator Mounts to Breaker, Cabinet)

**CONTROL/POWER SOURCE:**  
RSO-IAR-M18



# RSA-147

FOR USE WITH:

**Square D  
Load Break Switch**

## SPECIFICATIONS

**OPERATION:** Close/Trip

**WEIGHT:** 37.5 lbs.

**DIMENSIONS:\*** 43.0" x 12.3" x 6.0"

**COMPATIBLE WITH:** Power Zone Load Break Switch

**CONTROL/POWER SOURCE:**  
RSO-IAR-M18



\*All unit measurements are L x W x H

# RSA-147A

FOR USE WITH:  
**Square D**  
**Load Break Switch**

## SPECIFICATIONS

**OPERATION:** Close/Trip  
**WEIGHT:** 29.5 lbs.  
**DIMENSIONS:**\* 37.6" x 14.6" x 6.4"  
**COMPATIBLE WITH:** Power Zone Load Break Switch  
**CONTROL/POWER SOURCE:** RSO-IAR-M18



# RSA-149C

FOR USE WITH:  
**Merlin Gerin**  
**Molded Case Circuit Breaker**

## SPECIFICATIONS

**OPERATION:** Close/Trip  
**WEIGHT:** 11.1 lbs.  
**DIMENSIONS:**\* 18.6" x 5.3" x 5.1"  
**COMPATIBLE WITH:** COMPACT MCCB CK Frame, 400-1200 A  
**CONTROL/POWER SOURCE:** RSO-IAR-M18

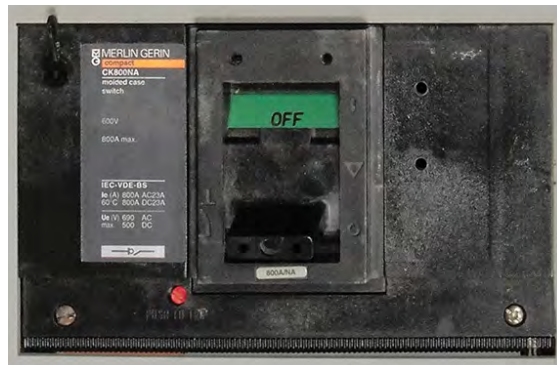

# RSA-149D

FOR USE WITH:  
**Merlin Gerin**  
**Molded Case Circuit Breaker**

## SPECIFICATIONS

**OPERATION:** Close/Trip  
**WEIGHT:** 33.0 lbs.  
**DIMENSIONS:**\* 22.6" x 11.6" x 7.0"  
**COMPATIBLE WITH:** COMPACT MCCB CM Frame, 1250-2500 A  
**CONTROL/POWER SOURCE:** RSO-IAR-M18



\*All unit measurements are L x W x H

# RSA-150

FOR USE WITH:  
**ABB/BBC/ITE**  
**Motor Control Center**

## SPECIFICATIONS

**OPERATION:** Close/Trip

**WEIGHT:** 26.8 lbs.

**DIMENSIONS:\*** 18.1" x 8.3" x 9.4"

**COMPATIBLE WITH:** 7850 Series Medium-Voltage Motor Starter (Air Contactor, Blue & Silver Label)

**CONTROL/POWER SOURCE:**  
RSO-IAR-M18

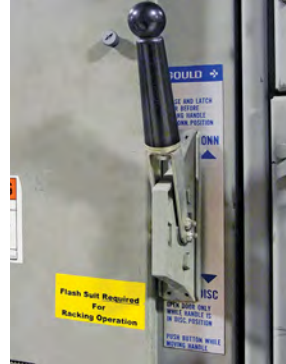

# RSA-151A

FOR USE WITH:  
**Federal Pacific Electric**  
**Air Circuit Breaker**

## SPECIFICATIONS

**OPERATION:** Charge/Close/Trip

**WEIGHT:** 24.7 lbs.

**DIMENSIONS:\*** 15.2" x 12.0" x 11.8"

**COMPATIBLE WITH:** Type H, HF-1 (All) for Non-magnetic Switchgear

**CONTROL/POWER SOURCE:**  
RSO-IAR-M18



# RSA-151B

FOR USE WITH:  
**Federal Pacific Electric**  
**Air Circuit Breaker**

## SPECIFICATIONS

**OPERATION:** Close/Trip

**WEIGHT:** 14.0 lbs.

**DIMENSIONS:\*** 12.72" x 11.6" x 7.3"

**COMPATIBLE WITH:** Type H/HF-1 (All Sizes)

**CONTROL/POWER SOURCE:**  
RSO-IIID-M18



\*All unit measurements are L x W x H

# RSA-152

FOR USE WITH:

**Cutler-Hammer  
Bolted Pressure Switch**

## SPECIFICATIONS

OPERATION: Close/Trip

WEIGHT: 38.0 lbs.

DIMENSIONS: \* 24.5" x 19.0" x 9.5"

COMPATIBLE WITH: Boltswitch SL/SLB Fused Power Circuit Devices (800-6000 A) Mounted in Dead Front Switchboards with Roughly 115° of Handle Travel, for VL/VLB/SL/SLB Switches without Shunt Trip, Twist Shunt Trip, or Motorized Shunt Trip

CONTROL/POWER SOURCE:  
RSO-IAR-M18

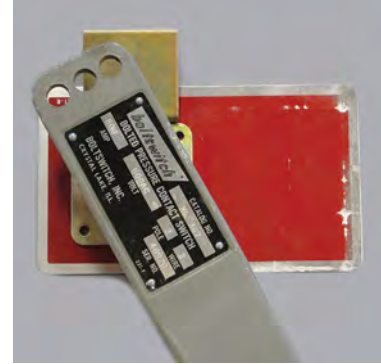

# RSA-152C

FOR USE WITH:

**Cutler-Hammer  
Bolted Pressure Switch**

## SPECIFICATIONS

OPERATION: Charge/Close/Trip

WEIGHT: 38.0 lbs.

DIMENSIONS: \* 24.5" x 19.0" x 9.5"

COMPATIBLE WITH: Boltswitch SL/SLB Fused Power Circuit Devices (800-6000 A) Mounted in Dead Front Switchboards with Roughly 90° of Handle Travel, for VL/VLB/SL/SLB Switches with Twist Shunt Trip. Not for SL/SLB Switches with No Shunt Trip or Motorized Shunt Trip.

CONTROL/POWER SOURCE: RSO-IIID-M18

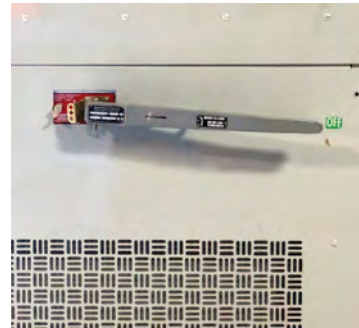

# RSA-152G

FOR USE WITH:

**Cutler-Hammer  
Bolted Pressure Switch**



## SPECIFICATIONS

OPERATION: Close/Trip

WEIGHT: 17.5 lbs.

DIMENSIONS: \* 7.0" x 10.3" x 9.0"

COMPATIBLE WITH: Boltswitch Series T 400-1200 A

CONTROL/POWER SOURCE:  
RSO-IAR-M18



\*All unit measurements are L x W x H

# RSA-153A

## SPECIFICATIONS

**OPERATION:** Close/Trip

**WEIGHT:** 8.2 lbs.

**DIMENSIONS:**\* 8.3" x 5.0" x 5.6"

**COMPATIBLE WITH:** Westinghouse Type FDP/Cutler-Hammer Type M50 Fusible Panelboard Switch - 30, 60, & 100 A Twin (5.5" Height)

**CONTROL/POWER SOURCE:**  
RSO-IAR-M18

FOR USE WITH:

**Westinghouse/Cutler-Hammer  
Panelboard Switch**



# RSA-153D

## SPECIFICATIONS

**OPERATION:** Close/Trip

**WEIGHT:** 25.0 lbs.

**DIMENSIONS:**\* 17.5" x 12.5" x 8.0"

**COMPATIBLE WITH:** Westinghouse Type FDP/Cutler-Hammer Type M50 Fusible Panelboard Switch - 400 & 600 A Single (15.125" Height)

**CONTROL/POWER SOURCE:**  
RSO-IAR-M18

FOR USE WITH:

**Westinghouse/Cutler-Hammer  
Panelboard Switch**



# RSA-153F

## SPECIFICATIONS

**OPERATION:** Close/Trip

**WEIGHT:** 25.4 lbs.

**DIMENSIONS:**\* 9.71" x 15.91" x 8.1"

**COMPATIBLE WITH:** Westinghouse Type FDP/Cutler-Hammer Type M50 Fusible Panelboard Switch - 800 & 1200 A Single (22" Height) 90° of Handle Travel. For Horizontal Unit, Switch Located on Middle Left-Hand Side.

**CONTROL/POWER SOURCE:**  
RSO-IAR-M18

FOR USE WITH:

**Westinghouse/Cutler-Hammer  
Panelboard Switch**



\*All unit measurements are L x W x H

# RSA-154A

FOR USE WITH:  
**ITE/Siemens  
Panelboard Switch**

## SPECIFICATIONS

OPERATION: Close/Trip

WEIGHT: 12.0 lbs.

DIMENSIONS:\* 10.5" x 8.0" x 7.0"

COMPATIBLE WITH: Vacu-Break Fusible Panel Units - V2BXXXX & V7BXXXX (30 or 60 A Twin; 5" Height)

CONTROL/POWER SOURCE:  
RSO-IAR-M18



# RSA-154B

FOR USE WITH:  
**ITE/Siemens  
Panelboard Switch**

## SPECIFICATIONS

OPERATION: Close/Trip

WEIGHT: 13.3 lbs.

DIMENSIONS:\* 8.2" x 7.0" x 7.3"

COMPATIBLE WITH: Vacu-Break Fusible Panel Units - V2EXXXX & V7EXXXX (30, 60, or 100 A Twin, or 200 A Single; 7.5" Height)

CONTROL/POWER SOURCE:  
RSO-IAR-M18



# RSA-154C

FOR USE WITH:  
**ITE/Siemens  
Panelboard Switch**

## SPECIFICATIONS

OPERATION: Close/Trip

WEIGHT: 16.0 lbs.

DIMENSIONS:\* 8.8" x 10.0" x 11.0"

COMPATIBLE WITH: Vacu-Break Fusible Panel Units - V2FXXXX & V7FXXXX (200 A Twin, or 200 A Single; 10" Height)

CONTROL/POWER SOURCE:  
RSO-IAR-M18



\*All unit measurements are L x W x H

# RSA-154D

FOR USE WITH:  
**ITE/Siemens  
Panelboard Switch**

## SPECIFICATIONS

**OPERATION:** Close/Trip

**WEIGHT:** 22.0 lbs.

**DIMENSIONS:**\* 10.2" x 12.6" x 10.3"

**COMPATIBLE WITH:** Vacu-Break Fusible Panel Units - V2HXXXX & V7HXXXX (400 or 600 A Single; 15' Height)

**CONTROL/POWER SOURCE:**  
RSO-IAR-M18



# RSA-154F

FOR USE WITH:  
**ITE/Siemens  
Panelboard Switch**

## SPECIFICATIONS

**OPERATION:** Close/Trip

**WEIGHT:** 25.0 lbs.

**DIMENSIONS:**\* 10.0" x 25.5" x 9.0"

**COMPATIBLE WITH:** Vacu-Break Fusible Panel Units Main Switch - VF357, VB357, VF358, VB358 (Suffix TL or BL; 800 or 1200 A; 25" Height)

**CONTROL/POWER SOURCE:**  
RSO-IAR-M18



# RSA-154G

FOR USE WITH:  
**ITE/Siemens  
Panelboard Switch**

## SPECIFICATIONS

**OPERATION:** Close/Trip

**WEIGHT:** 18.0 lbs.

**DIMENSIONS:**\* 15.0" x 7.0" x 7.5"

**COMPATIBLE WITH:** High Contact Pressure Switch - HCPXXXH (400, 600, 800, 1200 A 16.25" Height)

**CONTROL/POWER SOURCE:**  
RSO-IAR-M18



\*All unit measurements are L x W x H

# RSA-155

FOR USE WITH:

**Square D  
Insulated Case Circuit Breaker**

## SPECIFICATIONS

OPERATION: Charge/Close/Trip

WEIGHT: 23.6 lbs.

DIMENSIONS:\* 17.2" x 15.8" x 7.9"

COMPATIBLE WITH: SE Series - All

CONTROL/POWER SOURCE:  
RSO-IIID-M18



# RSA-155A

FOR USE WITH:

**Square D  
Insulated Case Circuit Breaker**



## SPECIFICATIONS

OPERATION: Close/Trip

WEIGHT: 10.0 lbs.

DIMENSIONS:\* 17.0" x 6.1" x 6.6"

COMPATIBLE WITH: SEF/SED - All Sizes

CONTROL/POWER SOURCE:  
RSO-IIID-M18



# RSA-157

FOR USE WITH:

**Cooper  
Transformer**

## SPECIFICATIONS

OPERATION: Close/Trip

WEIGHT: 16.3 lbs.

DIMENSIONS:\* 19.2" x 6.6" x 11.8"

COMPATIBLE WITH: Substation VFI  
Transformer

CONTROL/POWER SOURCE:  
RSO-IAR-M18



\*All unit measurements are L x W x H

# RSA-158

FOR USE WITH:

**Siemens**  
**Insulated Case Circuit Breaker**

## SPECIFICATIONS

**OPERATION:** Charge/Close/Trip

**WEIGHT:** 25.9 lbs.

**DIMENSIONS:**\* 19.9" x 18.5" x 8.2"

**COMPATIBLE WITH:** WN,  
WL, 3WN, 3WL Low-Voltage Air  
Circuit Breaker

**CONTROL/POWER SOURCE:**  
RSO-IIID-M18



# RSA-158A

FOR USE WITH:

**Siemens**  
**Insulated Case Circuit Breaker**



## SPECIFICATIONS

**OPERATION:** Close/Trip

**WEIGHT:** 14.0 lbs.

**DIMENSIONS:**\* 22.4" x 5.5" x 6.7"

**COMPATIBLE WITH:** Type WL - All Sizes

**CONTROL/POWER SOURCE:**  
RSO-IIID-M18



# RSA-159

FOR USE WITH:

**Square D**  
**Motor Control Center**

## SPECIFICATIONS

**OPERATION:** Close/Trip

**WEIGHT:** 17.7 lbs.

**DIMENSIONS:**\* 18.3" x 7.3" x 9.1"

**COMPATIBLE WITH:** Class 8198 High-  
Voltage Motor Starter

**CONTROL/POWER SOURCE:**  
RSO-IAR-M18



\*All unit measurements are L x W x H

# RSA-160

FOR USE WITH:

**General Electric  
Panelboard Switch**

## SPECIFICATIONS

OPERATION: Close/Trip

WEIGHT: 13.0 lbs.

DIMENSIONS:\* 13.8" x 5.7" x 7.8"

COMPATIBLE WITH: Spectra Type ADS  
Panelboard Disconnect Switch - 30 A, 60  
A, 100 A, 200 A

CONTROL/POWER SOURCE:  
RSO-IAR-M18



# RSA-160C

FOR USE WITH:

**General Electric  
Panelboard Switch**

## SPECIFICATIONS

OPERATION: Close/Trip

WEIGHT: 24.0 lbs.

DIMENSIONS:\* 22.7" x 10.7" x 10.0"

COMPATIBLE WITH: Spectra Type ADS  
Panelboard Disconnect Switch - 400 A,  
600 A

CONTROL/POWER SOURCE:  
RSO-IAR-M18



# RSA-160D

FOR USE WITH:

**General Electric  
Panelboard Switch**

## SPECIFICATIONS

OPERATION: Close/Trip

WEIGHT: 25.4 lbs.

DIMENSIONS:\* 17.1" x 14.3" x 11.6"

COMPATIBLE WITH: Spectra Type ADS  
Panelboard Disconnect Switch - 800 A,  
1200 A

CONTROL/POWER SOURCE: RSO-II



\*All unit measurements are L x W x H

# RSA-161

FOR USE WITH:  
**Square D  
Handle Operator**



## SPECIFICATIONS

**OPERATION:** Close/Trip

**WEIGHT:** 10.5 lbs.

**DIMENSIONS:**\* 11.0" x 7.3" x 7.5"

**COMPATIBLE WITH:** Class 9421 Type L Circuit Breaker Mechanism (3" Handle Assembly). Compatible with M-Flex Sizes C, D, E, and F drives. Not compatible with M-Flex Size H drive.

**CONTROL/POWER SOURCE:**  
RSO-IAR-M18



# RSA-161A

FOR USE WITH:  
**Square D  
Handle Operator**



## SPECIFICATIONS

**OPERATION:** Close/Trip

**WEIGHT:** 8.2 lbs.

**DIMENSIONS:**\* 7.3" x 7.3" x 9.5"

**COMPATIBLE WITH:** Class 9421 Type L Circuit Breaker Mechanism (3" Handle Assembly)

**CONTROL/POWER SOURCE:**  
RSO-IAR-M18

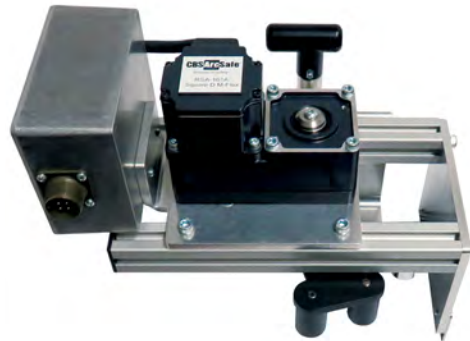

# RSA-162

FOR USE WITH:  
**General Electric  
Air Circuit Breaker**

## SPECIFICATIONS

**OPERATION:** Charge/Close/Trip

**WEIGHT:** 25.5 lbs.

**DIMENSIONS:**\* 6.3" x 19.2" x 18.5"

**COMPATIBLE WITH:** EntelliGuard G (400-6000 A, includes GG, GJ, GH, GK-04, 07, 08, 10, 13, 16, 20, 25, 32, 40, 50, 64)

**CONTROL/POWER SOURCE:**  
RSO-IIID-M18



\*All unit measurements are L x W x H

# RSA-162A

FOR USE WITH:  
**General Electric  
Air Circuit Breaker**

## SPECIFICATIONS

OPERATION: Close/Trip

WEIGHT: 16.8 lbs.

DIMENSIONS:\* 18.5" x 17.8" x 6.3"

COMPATIBLE WITH: EntelliGuard G (400-6000 A, includes GG, GJ, GH, GK-04, 07, 08, 10, 13, 16, 20, 25, 32, 40, 50, 64)

CONTROL/POWER SOURCE:  
RSO-IIID-M18



# RSA-163

FOR USE WITH:  
**ABB/Siemens  
Handle Operator**

## SPECIFICATIONS

OPERATION: Close/Trip

WEIGHT: 14.8 lbs.

DIMENSIONS:\* 11.6" x 7.8" x 5.4"

COMPATIBLE WITH: ABB Flange Handle Operator K7FCH, K7FCH4 & Siemens Max-Flex Handle Operator MFHM Series (Flush Mount, Large Red, Black Handle)

CONTROL/POWER SOURCE:  
RSO-IAR-M18



# RSA-163A

FOR USE WITH:  
**ABB/Siemens  
Handle Operator**

## SPECIFICATIONS

OPERATION: Close/Trip

WEIGHT: 9.3 lbs.

DIMENSIONS:\* 14.0" x 7.4" x 7.7"

COMPATIBLE WITH: Flange Handle Operator K7FHD-HS12, K7FHD-HS4 (Small, Red, Black Handle)

CONTROL/POWER SOURCE:  
RSO-IAR-M18

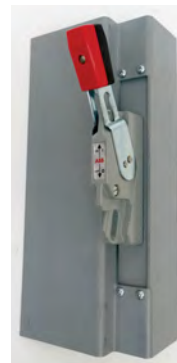

\*All unit measurements are L x W x H

# RSA-163C

FOR USE WITH:  
**ABB/Siemens  
Handle Operator**



## SPECIFICATIONS

**OPERATION:** Close/Trip

**WEIGHT:** 13.0 lbs.

**DIMENSIONS:**\* 16.7" x 6.0" x 8.5"

**COMPATIBLE WITH:** Flange Handle Operator OHF1C4, OHF1C12 (Medium, Green, Red Handle)

**CONTROL/POWER SOURCE:**  
RSO-IAR-M18



# RSA-163D

FOR USE WITH:  
**ABB/Siemens  
Handle Operator**

## SPECIFICATIONS

**OPERATION:** Close/Trip

**WEIGHT:** 15.7 lbs.

**DIMENSIONS:**\* 17.4" x 7.6" x 7.3"

**COMPATIBLE WITH:** ABB Flange Handle Operator K7FCH, K7FCH4 & Siemens Max-Flex Handle Operator MFHM Series (Recessed Mount, Large Red, Black Handle)

**CONTROL/POWER SOURCE:**  
RSO-IAR-M18



# RSA-164B

FOR USE WITH:  
**Square D  
Molded Case Circuit Breaker**

## SPECIFICATIONS

**OPERATION:** Close/Trip

**WEIGHT:** 6.2 lbs.

**DIMENSIONS:**\* 6.6" x 5.1" x 5.0"

**COMPATIBLE WITH:** PowerPact E Frame (includes ED, EG, EJ) 15-125 A

**CONTROL/POWER SOURCE:**  
RSO-IAR-M18



\*All unit measurements are L x W x H

# RSA-164C

FOR USE WITH:

**Square D  
Molded Case Circuit Breaker**

## SPECIFICATIONS

OPERATION: Close/Trip

WEIGHT: 7.5 lbs.

DIMENSIONS:\* 8.0" x 5.7" x 5.7"

COMPATIBLE WITH: PowerPact H Frame  
(includes HD, HG, HJ, HL, HR) 15-150 A

CONTROL/POWER SOURCE:  
RSO-IAR-M18



# RSA-164D

FOR USE WITH:

**Square D  
Molded Case Circuit Breaker**



## SPECIFICATIONS

OPERATION: Close/Trip

WEIGHT: 8.0 lbs.

DIMENSIONS:\* 14.5" x 6.0" x 6.0"

COMPATIBLE WITH: PowerPact Q Frame  
(includes QB, QD, QG, QJ) 70-250 A

CONTROL/POWER SOURCE:  
RSO-IAR-M18



# RSA-164E

FOR USE WITH:

**Square D  
Molded Case Circuit Breaker**

## SPECIFICATIONS

OPERATION: Close/Trip

WEIGHT: 10.0 lbs.

DIMENSIONS:\* 15.6" x 4.5" x 7.2"

COMPATIBLE WITH: PowerPact J Frame  
(includes JD, JG, JJ, JL, JR) 150-250 A

CONTROL/POWER SOURCE:  
RSO-IAR-M18



\*All unit measurements are L x W x H

# RSA-164H

## SPECIFICATIONS

**OPERATION:** Close/Trip

**WEIGHT:** 16.3 lbs.

**DIMENSIONS:\*** 18.0" x 6.5" x 6.5"

**COMPATIBLE WITH:** PowerPact L Frame (includes LD, LG, LJ, LL, LR) 250-600 A

**CONTROL/POWER SOURCE:**  
RSO-IAR-M18

FOR USE WITH:

**Square D  
Molded Case Circuit Breaker**



# RSA-164I

## SPECIFICATIONS

**OPERATION:** Close/Trip

**WEIGHT:** 16.0 lbs.

**DIMENSIONS:\*** 16.8" x 6.5" x 5.8"

**COMPATIBLE WITH:** PowerPact M Frame (includes MG, MJ) 300-800 A

**CONTROL/POWER SOURCE:**  
RSO-IAR-M18

FOR USE WITH:

**Square D  
Molded Case Circuit Breaker**



# RSA-164J

## SPECIFICATIONS

**OPERATION:** Close/Trip

**WEIGHT:** 14.0 lbs.

**DIMENSIONS:\*** 5.3" x 6.2" x 17.0"

**COMPATIBLE WITH:** PowerPact P Frame (includes PG, PJ, PK, PL; Manually Operated) 250-1200 A

**CONTROL/POWER SOURCE:**  
RSO-IAR-M18

FOR USE WITH:

**Square D  
Molded Case Circuit Breaker**



\*All unit measurements are L x W x H

# RSA-164K

FOR USE WITH:

**Square D  
Molded Case Circuit Breaker**

## SPECIFICATIONS

OPERATION: Close/Trip

WEIGHT: 18.8 lbs.

DIMENSIONS: \* 19.5" x 8.9" x 5.9"

COMPATIBLE WITH: PowerPact R Frame  
(includes RG, RJ, RK, RL) 600-3000 A

CONTROL/POWER SOURCE:  
RSO-IAR-M18



# RSA-164R

FOR USE WITH:

**Square D  
Molded Case Circuit Breaker**



## SPECIFICATIONS

OPERATION: Close/Trip

WEIGHT: 8.0 lbs.

DIMENSIONS: \* 9.7" x 6.0" x 6.2"

COMPATIBLE WITH: PowerPact B Frame  
(includes BD, BG, BJ, BK) 15-125 A

CONTROL/POWER SOURCE:  
RSO-IAR-M18



# RSA-166

FOR USE WITH:

**Square D  
Safety Switch**



## SPECIFICATIONS

OPERATION: Close/Trip

WEIGHT: 16.0 lbs.

DIMENSIONS: \* 22.3" x 9.2" x 7.0"

COMPATIBLE WITH: Heavy Duty Safety  
Switch 30 A, H, HU-221, 321, 361-N/A, N,  
NRB, RB, A, AWK (Series F5 & F6)

CONTROL/POWER SOURCE:  
RSO-IAR-M18



\*All unit measurements are L x W x H

# RSA-166A

FOR USE WITH:  
**Square D  
Safety Switch**



## SPECIFICATIONS

**OPERATION:** Close/Trip

**WEIGHT:** 14.0 lbs.

**DIMENSIONS:**\* 22.3" x 7.2" x 8.5"

**COMPATIBLE WITH:** Heavy Duty Safety Switch 200 A, H, HU-224, 324, 364, 464, 664-N/A, N, NRB, RB, A, AWK (Series F5 & F6)

**CONTROL/POWER SOURCE:**  
RSO-IAR-M18



# RSA-166B

FOR USE WITH:  
**Square D  
Safety Switch**

## SPECIFICATIONS

**OPERATION:** Close/Trip

**WEIGHT:** 13.2 lbs.

**DIMENSIONS:**\* 26.8" x 7.3" x 6.8"

**COMPATIBLE WITH:** Heavy Duty Safety Switch - 200 A - H, HU-224, 324, 364, 464-N, A, N, NRB, RB, A, AKW (Series E)

**CONTROL/POWER SOURCE:**  
RSO-IAR-M18



# RSA-166D

FOR USE WITH:  
**Square D  
Safety Switch**



## SPECIFICATIONS

**OPERATION:** Close/Trip

**WEIGHT:** 18.0 lbs.

**DIMENSIONS:**\* 14.8" x 10.3" x 7.3"

**COMPATIBLE WITH:** Heavy Duty Safety Switch 240 & 600 V; 400, 600, 800, & 1200 A (Series E4 & E5 Only, Compatible With H, HU-225, 226, 227, 228, 265, 266, 267, 268, 325, 326, 327, 328, 365, 366, 367, 368, 465, 466, 467, 468-N/A, N, NR, AWK, R)

**CONTROL/POWER SOURCE:** RSO-IAR-M18



\*All unit measurements are L x W x H

# RSA-166E

FOR USE WITH:

**Square D  
Safety Switch**



## SPECIFICATIONS

**OPERATION:** Close/Trip

**WEIGHT:** 12.0 lbs.

**DIMENSIONS:**\* 24.0" x 11.0" x 9.0"

**COMPATIBLE WITH:** Heavy Duty Safety Switch 60 & 100 A, H, HU-222, 223, 322, 323, 363, 462, 463-N/A, N, NRB, RB (Series F5 & F6)

**CONTROL/POWER SOURCE:**  
RSO-IAR-M18



# RSA-166G

FOR USE WITH:

**Square D  
Safety Switch**

## SPECIFICATIONS

**OPERATION:** Close/Trip

**WEIGHT:** 9.2 lbs.

**DIMENSIONS:**\* 18.0" x 8.9" x 8.4"

**COMPATIBLE WITH:** Heavy Duty Safety Switch - 30 A & 60 A - H, HU-221, 222, 321, 322, 361-DS (Series F6; NEMA 4, 4X, 5 Stainless Steel Enclosure; Required Modification)

**CONTROL/POWER SOURCE:**  
RSO-IAR-M18



# RSA-167

FOR USE WITH:

**Allen-Bradley/Rockwell Automation  
Motor Control Center**

## SPECIFICATIONS

**OPERATION:** Close/Trip

**WEIGHT:** 15.0 lbs.

**DIMENSIONS:**\* 7.8" x 7.5" x 14.0"

**COMPATIBLE WITH:** 1494F-P1-NP Series A Non-Metallic Molded Plastic Operating Handle (Recessed Mounted)

**CONTROL/POWER SOURCE:**  
RSO-IAR-M18



\*All unit measurements are L x W x H

# RSA-168

FOR USE WITH:  
**General Electric  
Safety Switch**



## SPECIFICATIONS

**OPERATION:** Close/Trip

**WEIGHT:** 23.0 lbs.

**DIMENSIONS:**\* 33.0" x 9.2" x 6.8"

**COMPATIBLE WITH:** Heavy Duty Safety Switch Type TC 800 & 1200 A; NEMA Type 1 & 3R; Models 7, 8, 9, 10 (includes TC36367, TC36368, TC72267, TC72367, TC72268, TC72368, TC72267R, TC72367R, TC72268R, & TC72368R)

**CONTROL/POWER SOURCE:**  
RSO-IAR-M18



# RSA-169

FOR USE WITH:  
**General Electric  
Safety Switch**



## SPECIFICATIONS

**OPERATION:** Close/Trip

**WEIGHT:** 10.0 lbs.

**DIMENSIONS:**\* 10.5" x 8.0" x 8.0"

**COMPATIBLE WITH:** THN Series Heavy Duty Safety Switch, Operates Catalog Number THN3321, 30 A/240 VAC/250 VDC

**CONTROL/POWER SOURCE:**  
RSO-IAR-M18



# RSA-169A

FOR USE WITH:  
**General Electric  
Safety Switch**

## SPECIFICATIONS

**OPERATION:** Close/Trip

**WEIGHT:** 17.9 lbs.

**DIMENSIONS:**\* 15.0" x 8.2" x 7.3"

**COMPATIBLE WITH:** TH Series Heavy Duty Safety Switch (includes TH3365)

**CONTROL/POWER SOURCE:**  
RSO-IAR-M18



\*All unit measurements are L x W x H

# RSA-169C

FOR USE WITH:  
**General Electric  
Safety Switch**



## SPECIFICATIONS

**OPERATION:** Close/Trip

**WEIGHT:** 13.0 lbs.

**DIMENSIONS:**\* 17.5" x 7.5" x 9.0"

**COMPATIBLE WITH:** Heavy Duty Safety Switches Listed in Drawing Number 10103091SH112 (TH3225, TH3225C, TH3226, TH3226C, TH4325, TH4325C, TH4326, TH4326C, TH3325, TH3326, TH3365, TH3366, TH4365C, TH4366C, THN3365, and THN3366)  
NEMA Type 1 enclosure, 400-600 A

**CONTROL/POWER SOURCE:** RSO-IAR-M18



# RSA-169D

FOR USE WITH:  
**General Electric  
Safety Switch**



## SPECIFICATIONS

**OPERATION:** Close/Trip

**WEIGHT:** 13.0 lbs.

**DIMENSIONS:**\* 22.5" x 6.0" x 7.7"

**COMPATIBLE WITH:** TG Series General Duty Safety Switch 200 A, 240 VAC (Switch Has Flat Rounded Handle, Not Thick Square Handle)

**CONTROL/POWER SOURCE:**  
RSO-IAR-M18



# RSA-169F

FOR USE WITH:  
**General Electric  
Safety Switch**



## SPECIFICATIONS

**OPERATION:** Close/Trip

**WEIGHT:** 12.0 lbs.

**DIMENSIONS:**\* 18.5" x 6.5" x 7.5"

**COMPATIBLE WITH:** TH Series General Duty Safety Switch, 30 A, 240 VAC (Switch Has Thick Square Handle with Raised Front Face) Operates MPN - N.P. 266209-A/B

**CONTROL/POWER SOURCE:**  
RSO-IAR-M18



\*All unit measurements are L x W x H

# RSA-174E

FOR USE WITH:  
**ABB/SACE**  
**Molded Case Circuit Breaker**

## SPECIFICATIONS

**OPERATION:** Close/Trip

**WEIGHT:** 14.1 lbs.

**DIMENSIONS:**\* 6.1" x 8.9 x 11.6"

**COMPATIBLE WITH:** Tmax Molded Case Circuit Breaker (MCCB) (Except Tmax XT): Size T7M - 1000 & 1200 A Frame (Stored Energy Mechanism, Breaker Recessed into Cabinet, Actuator Mounts to Breaker, Cabinet)

**CONTROL/POWER SOURCE:**  
RSO-IAR-M18

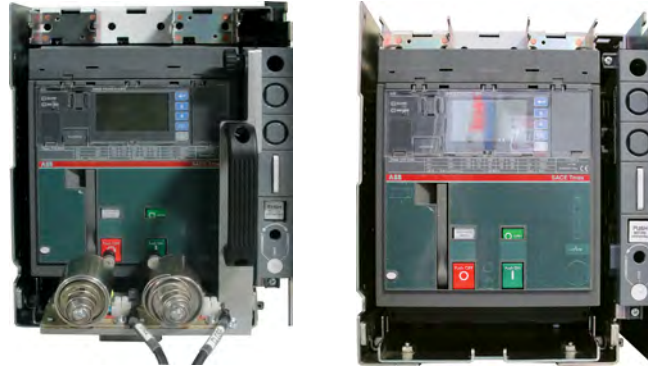

# RSA-174F

FOR USE WITH:  
**ABB/SACE**  
**Molded Case Circuit Breaker**



## SPECIFICATIONS

**OPERATION:** Close/Trip

**WEIGHT:** 14.8 lbs.

**DIMENSIONS:**\* 6.6" x 10.5" x 17.1"

**COMPATIBLE WITH:** Tmax Molded Case Circuit Breaker (MCCB) (Except Tmax XT and T7M), Size T7 (includes T7, T7H, T7L, T7S): 1000-1600 A Frame (Toggle Mechanism, Breaker Recessed into Cabinet, Actuator Mounts to Breaker, Cabinet)

**CONTROL/POWER SOURCE:** RSO-IAR-M18

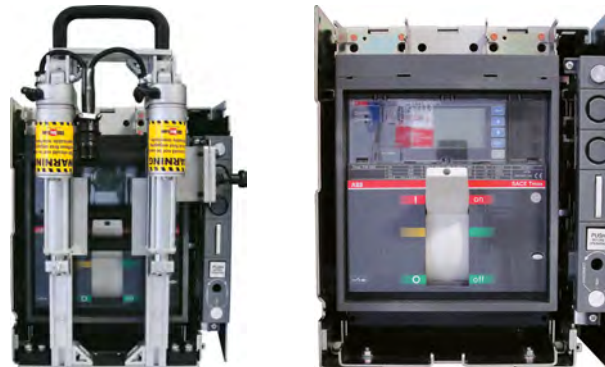

# RSA-175B

FOR USE WITH:  
**Federal Pacific Electric**  
**Molded Case Circuit Breaker**

## SPECIFICATIONS

**OPERATION:** Close/Trip

**WEIGHT:** 16.8 lbs.

**DIMENSIONS:**\* 17.6" x 8.3" x 7.6"

**COMPATIBLE WITH:** J Frame 70-225 A (includes HJ, HJL, NJ, NJJ, NJL, NJS)

**CONTROL/POWER SOURCE:**  
RSO-IAR-M18



\*All unit measurements are L x W x H

# RSA-175E

FOR USE WITH:

**Federal Pacific Electric  
Molded Case Circuit Breaker**

## SPECIFICATIONS

OPERATION: Close/Trip

WEIGHT: 16.4 lbs.

DIMENSIONS:\* 18.1" x 8.1" x 7.6"

COMPATIBLE WITH: M Frame 150-800 A  
(includes HM, HMN, NM)

CONTROL/POWER SOURCE:  
RSO-IAR-M18



# RSA-176A

FOR USE WITH:

**Schneider Electric/Square D  
Vacuum Circuit Breaker**

## SPECIFICATIONS

OPERATION: Close/Trip

WEIGHT: 11.6 lbs.

DIMENSIONS:\* 13.5" x 6.5" x 6.0"

COMPATIBLE WITH: Type VR 1200-3000 A  
(Includes VR05, VR08, VR15)

CONTROL/POWER SOURCE: RSO-IAR-M18



# RSA-177

FOR USE WITH:

**Federal Pacific Electric  
Panelboard Switch**

## SPECIFICATIONS

OPERATION: Close/Trip

WEIGHT: 19.0 lbs.

DIMENSIONS:\* 16.7" x 7.8" x 10.6"

COMPATIBLE WITH: QMQB Panelboard  
Switch 30-100 A Single or Twin (Gray  
Metal Handle Operator; Twin Includes  
QMQB3332, 3336, 6632, 6636, 1132, 1136;  
Single Includes QMQB1032, 1036)

CONTROL/POWER SOURCE:  
RSO-IAR-M18



\*All unit measurements are L x W x H

# RSA-177A

FOR USE WITH:

**Federal Pacific Electric  
Panelboard Switch**



## SPECIFICATIONS

**OPERATION:** Close/Trip

**WEIGHT:** 11.0 lbs.

**DIMENSIONS:**\* 8.5" x 6.0" x 6.5"

**COMPATIBLE WITH:** QMQB Panelboard Switch 200 A Single (Gray Metal Handle Operator; includes QMQB2032, 2036)

**CONTROL/POWER SOURCE:**  
RSO-IAR-M18



# RSA-177C

FOR USE WITH:

**Federal Pacific Electric  
Panelboard Switch**



## SPECIFICATIONS

**OPERATION:** Close/Trip

**WEIGHT:** 24.0 lbs.

**DIMENSIONS:**\* 20.0" x 14.5" x 10.0"

**COMPATIBLE WITH:** QMQB Panelboard Switch 800-1200 A Single (Gray Metal Handle Operator; includes QMQB8032, 8036, 9032, 9036)

**CONTROL/POWER SOURCE:**  
RSO-IAR-M18



# RSA-180

FOR USE WITH:

**Merlin Gerin/Square D  
Insulated Case Circuit Breaker**



## SPECIFICATIONS

**OPERATION:** Charge/Close/Trip

**WEIGHT:** 14.1 lbs.

**DIMENSIONS:**\* 13.1" x 17.4" x 9.0"

**COMPATIBLE WITH:** Masterpact NT - All Sizes

**CONTROL/POWER SOURCE:**  
RSO-IIID-M18



\*All unit measurements are L x W x H

# RSA-180A

FOR USE WITH:

**Schneider Electric/Square D  
Insulated Case Circuit Breaker**



## SPECIFICATIONS

OPERATION: Close/Trip

WEIGHT: 12.0 lbs.

DIMENSIONS:\* 16.6" x 6.0" x 6.5"

COMPATIBLE WITH: Masterpact NT - All Sizes

CONTROL/POWER SOURCE:  
RSO-IIID-M18



# RSA-181

FOR USE WITH:

**Square D  
Bolted Pressure Switch**

## SPECIFICATIONS

OPERATION: Close/Trip

WEIGHT: 36.7 lbs.

DIMENSIONS:\* 25.8" x 18.0" x 10.8"

COMPATIBLE WITH: Manually Operated Type Bolt-Loc BL Series Switches (800-3000 A); and Type AV Switch - AVO Series Switches with AVFQ, AVSQ Handle Operator (800-1200 A, Single Throw, Load-Break, Dead Front)

CONTROL/POWER SOURCE:  
RSO-IAR-M18



# RSA-183

FOR USE WITH:

**General Electric  
Handle Operator**

## SPECIFICATIONS

OPERATION: Close/Trip

WEIGHT: 14.6 lbs.

DIMENSIONS:\* 17.8" x 7.2" x 6.1"

COMPATIBLE WITH: Flange Handle STDA1 (Small with Red, Black Plastic)

CONTROL/POWER SOURCE:  
RSO-IAR-M18



\*All unit measurements are L x W x H

# RSA-183A

FOR USE WITH:  
**General Electric  
Handle Operator**

## SPECIFICATIONS

**OPERATION:** Close/Trip

**WEIGHT:** 17.2 lbs.

**DIMENSIONS:**\* 19.1" x 7.3" x 7.8"

**COMPATIBLE WITH:** Flange Handle  
STDA2 (Large with Red, Black Plastic)

**CONTROL/POWER SOURCE:**  
RSO-IAR-M18



# RSA-184

FOR USE WITH:  
**Cutler-Hammer  
Panelboard Switch**

## SPECIFICATIONS

**OPERATION:** Close/Trip

**WEIGHT:** 9.0 lbs.

**DIMENSIONS:**\* 6.2" x 8.3" x 4.5"

**COMPATIBLE WITH:** FDPW Fusible  
Panelboard Switch - 30, 60, & 100 A  
Twin (Horizontal Fused Switch, 5.375" H)

**CONTROL/POWER SOURCE:**  
RSO-IAR-M18



# RSA-184C

FOR USE WITH:  
**Cutler-Hammer  
Panelboard Switch**

## SPECIFICATIONS

**OPERATION:** Close/Trip

**WEIGHT:** 16.5 lbs.

**DIMENSIONS:**\* 14.75" x 7.75" x 8.25"

**COMPATIBLE WITH:** FDPW Fusible  
Panelboard Switch 200 A Single  
(Horizontal Fused Switch, 8.188" H)

**CONTROL/POWER SOURCE:**  
RSO-IAR-M18



\*All unit measurements are L x W x H

# RSA-184D

FOR USE WITH:  
**Cutler-Hammer  
Panelboard Switch**

## SPECIFICATIONS

OPERATION: Close/Trip

WEIGHT: 20.7 lbs.

DIMENSIONS:\* 12.5" x 11.0" x 10.8"

COMPATIBLE WITH: FDPW Fusible  
Panelboard Switch - 400 A Single  
(Horizontal Fused Switch, 12.313" H)

CONTROL/POWER SOURCE:  
RSO-IAR-M18



# RSA-184F

FOR USE WITH:  
**Cutler-Hammer  
Panelboard Switch**

## SPECIFICATIONS

OPERATION: Close/Trip

WEIGHT: 20.2 lbs.

DIMENSIONS:\* 15.2" x 11.5" x 10.8"

COMPATIBLE WITH: FDPW Fusible  
Panelboard Switch - 600 & 800 A Single  
(Horizontal Fused Switch, 15.063" H)

CONTROL/POWER SOURCE:  
RSO-IAR-M18



# RSA-185

FOR USE WITH:  
**Square D  
Motor Control Center**

## SPECIFICATIONS

OPERATION: Close/Trip

WEIGHT: 13.1 lbs.

DIMENSIONS:\* 11.9" x 7.6" x 6.1"

COMPATIBLE WITH: Model 5 MCC  
Bucket Size 1-5

CONTROL/POWER SOURCE:  
RSO-IAR-M18



\*All unit measurements are L x W x H

# RSA-186

FOR USE WITH:  
**Westinghouse  
Load Break Switch**

## SPECIFICATIONS

**OPERATION:** Close/Trip

**WEIGHT:** 21.0 lbs.

**DIMENSIONS:\*** 6.8 x 8.5 x 26.5"

**COMPATIBLE WITH:** Type ADM  
Disconnect Switch

**CONTROL/POWER SOURCE:**  
RSO-IAR-M18



# RSA-187

FOR USE WITH:  
**General Electric  
Molded Case Circuit Breaker**

## SPECIFICATIONS

**OPERATION:** Close/Trip

**WEIGHT:** 16.7 lbs.

**DIMENSIONS:\*** 30.6" x 8.2" x 6.4"

**COMPATIBLE WITH:** K Line MCCB,  
1200 A Frame Size (Includes THKM/  
TKC/TKL/TKM). Flush Mounted with  
Lockout/Tagout Device Installed

**CONTROL/POWER SOURCE:**  
RSO-IAR-M18



# RSA-187A

FOR USE WITH:  
**General Electric  
Molded Case Circuit Breaker**



## SPECIFICATIONS

**OPERATION:** Close/Trip

**WEIGHT:** 6.8 lbs.

**DIMENSIONS:\*** 5.6" x 8.0" x 5.6"

**COMPATIBLE WITH:** E Line, 150 A Frame  
Size, Type TE, TEB, TEC, TECL, TED,  
TEML, THED & THCL-1 Current Limiting  
Breaker (Flush Mounted)

**CONTROL/POWER SOURCE:**  
RSO-IAR-M18



\*All unit measurements are L x W x H

# RSA-187B

FOR USE WITH:

**General Electric  
Molded Case Circuit Breaker**

## SPECIFICATIONS

**OPERATION:** Close/Trip

**WEIGHT:** 7.5 lbs.

**DIMENSIONS:**\* 8.0" x 5.7" x 5.5"

**COMPATIBLE WITH:** F Line, 225A Frame Size, Type THFK, TF, TFC, TFJ, TFK, TFL & THCL-2, THCL-4 Current Limiting Breaker (Flush Mounted)

**CONTROL/POWER SOURCE:**  
RSO-IAR-M18



# RSA-187C

FOR USE WITH:

**General Electric  
Molded Case Circuit Breaker**

## SPECIFICATIONS

**OPERATION:** Close/Trip

**WEIGHT:** 13.0 lbs.

**DIMENSIONS:**\* 4.5" x 14.0" x 7.5"

**COMPATIBLE WITH:** J Line, 600 A Frame Size THJK, TJ, TJC, TJD, TJJ, TJK, TJL (Flush Mounted)

**CONTROL/POWER SOURCE:**  
RSO-IAR-M18

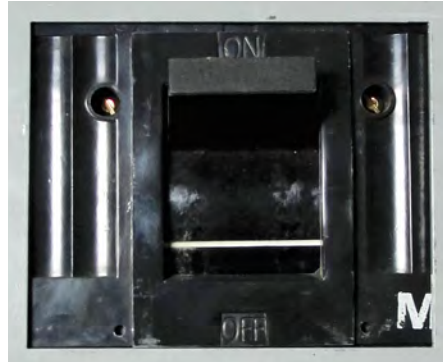

# RSA-187F

FOR USE WITH:

**General Electric  
Molded Case Circuit Breaker**

## SPECIFICATIONS

**OPERATION:** Close/Trip

**WEIGHT:** 10.0 lbs.

**DIMENSIONS:**\* 18.5" x 3.5" x 7.2"

**COMPATIBLE WITH:** F Line 225 A Frame Size Type THFK/TF/TFC/TFJ/TFK/TFL (Recessed Mounted)

**CONTROL/POWER SOURCE:**  
RSO-IAR-M18



\*All unit measurements are L x W x H

# RSA-187G

FOR USE WITH:

**General Electric  
Molded Case Circuit Breaker**

## SPECIFICATIONS

**OPERATION:** Close/Trip

**WEIGHT:** 6.3 lbs.

**DIMENSIONS:**\* 9.5" x 9.3" x 5.6"

**COMPATIBLE WITH:** J Line, 600 A Frame Size THJK, TJ, TJC, TJD, TJJ, TJK, TJL (Recessed Mounted)

**CONTROL/POWER SOURCE:**  
RSO-IAR-M18



# RSA-187H

FOR USE WITH:

**General Electric  
Molded Case Circuit Breaker**

## SPECIFICATIONS

**OPERATION:** Close/Trip

**WEIGHT:** 12.5 lbs.

**DIMENSIONS:**\* 20.1" x 5.6" x 7.3"

**COMPATIBLE WITH:** K Line, 1200 A Frame Size THKM, TKC, TKL, TKM (Recessed Mounted)

**CONTROL/POWER SOURCE:**  
RSO-IAR-M18



# RSA-187I

FOR USE WITH:

**General Electric  
Molded Case Circuit Breaker**

## SPECIFICATIONS

**OPERATION:** Close/Trip

**WEIGHT:** 11.0 lbs.

**DIMENSIONS:**\* 16.6" x 3.7" x 5.0"

**COMPATIBLE WITH:** THLC2 Series 175-400 A Frame Size, Type THLC2 & THLC4 Series

**CONTROL/POWER SOURCE:**  
RSO-IAR-M18



\*All unit measurements are L x W x H

# RSA-187J

FOR USE WITH:

**General Electric  
Molded Case Circuit Breaker**



## SPECIFICATIONS

**OPERATION:** Close/Trip

**WEIGHT:** 7.0 lbs.

**DIMENSIONS:**\* 10.0" x 9.9" x 5.1"

**COMPATIBLE WITH:** Type TEY MCCB  
10-100 A, Includes Three Pole

**CONTROL/POWER SOURCE:**  
RSO-IAR-M18



# RSA-188B

FOR USE WITH:

**General Electric  
Handle Operator**



## SPECIFICATIONS

**OPERATION:** Close/Trip

**WEIGHT:** 16.5 lbs.

**DIMENSIONS:**\* 14.6" x 6.0" x 9.5"

**COMPATIBLE WITH:** AV Line  
Switchboard Rotary Operating Handle  
For Individually Mounted Devices, Branch  
Fusible Switch (30-100 A) Or Branch  
Circuit Breaker (TEB, TED, TQD, TFJ, TFK,  
TJD, TJK, TB1 Frames)

**CONTROL/POWER SOURCE:**  
RSO-IAR-M18



# RSA-188C

FOR USE WITH:

**General Electric  
Handle Operator**

## SPECIFICATIONS

**OPERATION:** Close/Trip

**WEIGHT:** 12.3 lbs.

**DIMENSIONS:**\* 19.9" x 8.9" x 7.8"

**COMPATIBLE WITH:** AV Line  
Switchboard Rotary Operating Handle  
for Individually Mounted Devices, Branch  
Fusible Switch (200 A) or Branch Circuit  
Breaker (TKM, TB4, TB6, TB8, TJS, & TKS  
Frames)

**CONTROL/POWER SOURCE:**  
RSO-IAR-M18



\*All unit measurements are L x W x H

# RSA-189

FOR USE WITH:  
**Cutler-Hammer  
Motor Control Center**

## SPECIFICATIONS

**OPERATION:** Close/Trip

**WEIGHT:** 11.0 lbs.

**DIMENSIONS:**\* 7.7" x 6.1" x 4.4"

**COMPATIBLE WITH:** F10 Unitrol, 9800 Unitrol Lever Size 1-4

**CONTROL/POWER SOURCE:** RSO-IAR-M18



# RSA-192E

FOR USE WITH:  
**ABB  
Handle Operator**



## SPECIFICATIONS

**OPERATION:** Close/Trip

**WEIGHT:** 9.5 lbs.

**DIMENSIONS:**\* 8.0" x 6.6" x 7.2"

**COMPATIBLE WITH:** Type OHY/OHB/OHG (45 mm and 65 mm Length); Black/Red & Red/Yellow Plastic, Grey/White Handle. Mounted on a Non-Metallic Enclosure, Not for Stainless Steel Handles on Stainless Steel Panels.

**CONTROL/POWER SOURCE:** RSO-IAR-M18



# RSA-195A

FOR USE WITH:  
**General Electric  
Molded Case Circuit Breaker**

## SPECIFICATIONS

**OPERATION:** Close/Trip

**WEIGHT:** 16 lbs.

**DIMENSIONS:**\* 22.5" x 5.75" x 6.25"

**COMPATIBLE WITH:** Tri-Break (Fused) TB Frame MCCB Size TB4, TBC4 (125-400 A)

**CONTROL/POWER SOURCE:** RSO-IAR-M18



\*All unit measurements are L x W x H

# RSA-196

FOR USE WITH:

**General Electric  
Molded Case Circuit Breaker**

## SPECIFICATIONS

OPERATION: Close/Trip

WEIGHT: 40.0 lbs.

DIMENSIONS: \* 42.3" x 18.9" x 13.7"

COMPATIBLE WITH: ZJ8 Link  
Operated Air Switch

CONTROL/POWER SOURCE:  
RSO-IAR-M18



# RSA-197E

FOR USE WITH:

**ITE/Gould/Bulldog/Siemens  
Panelboard Switch**



## SPECIFICATIONS

OPERATION: Close/Trip

WEIGHT: 16.0 lbs.

DIMENSIONS: \* 8.0" x 8.8" x 8.0"

COMPATIBLE WITH: Vacu-Break  
Heavy Duty Safety Switch Type 1 for  
General or Indoor Use. 60 A Frame Size  
(EX: CAT #NF352) for Vintage Bulldog/  
ITE Series with More Rounded Face.

CONTROL/POWER SOURCE:  
RSO-IAR-M18



# RSA-198

FOR USE WITH:

**ABB  
Handle Operator**

## SPECIFICATIONS

OPERATION: Close/Trip

WEIGHT: 13.7 lbs.

DIMENSIONS: \* 10.8" x 4.9" x 7.5"

COMPATIBLE WITH: Variable Depth  
Square Type 1 K2VD-H for Isomax S1  
Frame MCCB (Flush Mounted, 2.56"  
Diameter Base)

CONTROL/POWER SOURCE:  
RSO-IAR-M18



\*All unit measurements are L x W x H

# RSA-198A

FOR USE WITH:  
**ABB**  
**Handle Operator**

## SPECIFICATIONS

**OPERATION:** Close/Trip

**WEIGHT:** 15.0 lbs.

**DIMENSIONS:**\* 12.6" x 6.0" x 8.0"

**COMPATIBLE WITH:** Variable Depth Square Type 1 K5VD-H for Isomax S3, S4, & S5 Frame MCCB & K7VD-H for Isomax S6 & S7 Frame MCCB; Direct Mount K5RH for Isomax S3, S4, & S5 Frame MCCB (Flush Mounted, 4.13" x 4.13" Square Base)

**CONTROL/POWER SOURCE:**  
RSO-IAR-M18



# RSA-200A

FOR USE WITH:  
**Kraus & Naimer**  
**Breaker Control Switch**

## SPECIFICATIONS

**OPERATION:** Close/Trip

**WEIGHT:** 8.0 lbs.

**DIMENSIONS:**\* 9.5" x 4.3" x 6.5"

**COMPATIBLE WITH:** Selector Switch Size S1 (2.5" x 2.5" Square Base) With "F" Type Handle

**CONTROL/POWER SOURCE:**  
RSO-IAR-M18



# RSA-200B

FOR USE WITH:  
**Kraus & Naimer**  
**Breaker Control Switch**

## SPECIFICATIONS

**OPERATION:** Close/Trip

**WEIGHT:** 7.7 lbs.

**DIMENSIONS:**\* 7.5" x 5.7" x 7.5"

**COMPATIBLE WITH:** Selector Switch Size S1 With F221 Face Configuration for Label at Top, Handle Type "O" Model G412

**CONTROL/POWER SOURCE:**  
RSO-IAR-M18



\*All unit measurements are L x W x H

# RSA-201

FOR USE WITH:

**Square D  
Enclosed Circuit Breaker**

## SPECIFICATIONS

**OPERATION:** Close/Trip

**WEIGHT:** 12.2 lbs.

**DIMENSIONS:**\* 23.0" x 5.2" x 9.0"

**COMPATIBLE WITH:** NEMA 12, 3R, Series E3, 100-600 A (includes LEL, LXL, LXIL, LCL, & LIL Housed in LX600 AWK) and 300-1000 A (includes MAL, MHL, & MXL Housed in MA1000 AWK)

**CONTROL/POWER SOURCE:**  
RSO-IAR-M18



# RSA-201B

FOR USE WITH:

**Square D  
Safety Switch**



## SPECIFICATIONS

**OPERATION:** Close/Trip

**WEIGHT:** 9.5 lbs.

**DIMENSIONS:**\* 41.0" x 7.3" x 6.5"

**COMPATIBLE WITH:** NEMA 3, 3R, 4, 4X, 5, 12 (includes MGL, MJL, PGL, PJL, PKL, PLL 250-800 A) Housed in an M800SS Stainless Steel Enclosure

**CONTROL/POWER SOURCE:**  
RSO-IAR-M18



# RSA-202

FOR USE WITH:

**ABB  
SF6 Circuit Breaker**

## SPECIFICATIONS

**OPERATION:** Close/Trip

**WEIGHT:** 5.4 lbs.

**DIMENSIONS:**\* 6.7" x 6.3" x 5.2"

**COMPATIBLE WITH:** HGI 2 and HGI 3 Generator Circuit Breaker, 17.5-24 kV, 6300-8000 A

**CONTROL/POWER SOURCE:**  
RSO-IAR-M18

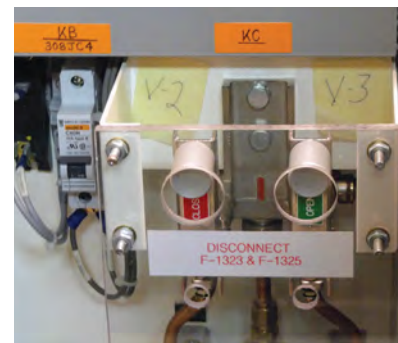

\*All unit measurements are L x W x H

# RSA-203

FOR USE WITH:  
**General Electric  
Air Circuit Breaker**

## SPECIFICATIONS

**OPERATION:** Charge/Close/Trip

**WEIGHT:** 27.8 lbs.

**DIMENSIONS:**\* 21.8" x 17.5" x 11.6"

**COMPATIBLE WITH:** M-Pact Low-Voltage Air Circuit Breaker (includes 804, 812, 1616, 1620, 2025, and 3037 Frame Sizes)

**CONTROL/POWER SOURCE:**  
RSO-IIID-M18



# RSA-204

FOR USE WITH:  
**Rockwell Automation/Allen Bradley  
Rotary Handle**



## SPECIFICATIONS

**OPERATION:** Close/Trip

**WEIGHT:** 16.5 lbs.

**DIMENSIONS:**\* 14.5" x 6.0" x 7.0"

**COMPATIBLE WITH:** Bulletin 1494R Variable Depth Door Mounted Rotary Disconnect Switch 30-60 A (Includes 1494R-N30, 1494R-N60)

**CONTROL/POWER SOURCE:**  
RSO-IAR-M18



# RSA-204A

FOR USE WITH:  
**Rockwell Automation/Allen Bradley  
Rotary Handle**



## SPECIFICATIONS

**OPERATION:** Close/Trip

**WEIGHT:** 16.5 lbs.

**DIMENSIONS:**\* 15.5" x 5.7" x 8.5"

**COMPATIBLE WITH:** Bulletin 1494R Variable Depth Door Mounted Rotary Disconnect Switch 100-200 A (Includes 1494R-N100, 1494R-N200)

**CONTROL/POWER SOURCE:**  
RSO-IAR-M18



\*All unit measurements are L x W x H

# RSA-205

FOR USE WITH:

**Bulldog/ITE/Siemens  
Safety Switch**

## SPECIFICATIONS

**OPERATION:** Close/Trip

**WEIGHT:** 15.2 lbs.

**DIMENSIONS:**\* 29.6" x 4.4" x 9.7"

**COMPATIBLE WITH:** General Duty Enclosed Switch, Legacy Style, Vacu-Break, Clampmatic, 240, 600 V, 400 A (includes SN-325, SN-365)

**CONTROL/POWER SOURCE:**  
RSO-IAR-M18



# RSA-205B

FOR USE WITH:

**Siemens/ITE  
Safety Switch**



## SPECIFICATIONS

**OPERATION:** Close/Trip

**WEIGHT:** 10.5 lbs.

**DIMENSIONS:**\* 19.0" x 10.3" x 10.0"

**COMPATIBLE WITH:** Oversized 30 A and 60 A Switch, 2/3 Pole, 240/600 V, includes HF361RL, HNF361RL, HF222NR, HF322NR, HF262R, HF362R, HF362NR, HNF262NR, and HNF362NR

**CONTROL/POWER SOURCE:**  
RSO-IAR-M18



# RSA-205C

FOR USE WITH:

**Siemens/ITE  
Safety Switch**



## SPECIFICATIONS

**OPERATION:** Close/Trip

**WEIGHT:** 15.0 lbs.

**DIMENSIONS:**\* 31.0" x 11.3" x 9.5"

**COMPATIBLE WITH:** HF364NR, HF364R, RPV, RPVPG, 200 A, Three Pole, 240/600 V

**CONTROL/POWER SOURCE:**  
RSO-IAR-M18



\*All unit measurements are L x W x H

# RSA-205G

FOR USE WITH:  
**Siemens/ITE  
Safety Switch**



## SPECIFICATIONS

**OPERATION:** Close/Trip

**WEIGHT:** 46.5 lbs.

**DIMENSIONS:**\* 44.5" x 16.3" x 9.0"

**COMPATIBLE WITH:** NRH425-1, F355  
Single Throw Enclosed Switch 400  
A/600 V

**CONTROL/POWER SOURCE:**  
RSO-IAR-M18



# RSA-209

FOR USE WITH:  
**General Electric  
Air Circuit Breaker**

## SPECIFICATIONS

**OPERATION:** Charge/Close/Trip

**WEIGHT:** 21.9 lbs.

**DIMENSIONS:**\* 19.6" x 12.4" x 9.4"

**COMPATIBLE WITH:** Type AL Manually  
Operated Air Circuit Breaker - Up to 1600  
A (Dead Front with Front Enclosure or  
Enclosed with Pull Box, includes AL-2,  
ALF-2, AL-2-Y1, AL-2-Y2, AL-2-50, AL-2-  
50Y1, AL-50Y2, AL-2-50Y3)

**CONTROL/POWER SOURCE:**  
RSO-IIID-M18



# RSA-210

FOR USE WITH:  
**Klockner Moeller/Moeller  
Electric Handle Operator**

## SPECIFICATIONS

**OPERATION:** Close/Trip

**WEIGHT:** 8.5 lbs.

**DIMENSIONS:**\* 5.5" x 4.5" x 8.0"

**COMPATIBLE WITH:** Door Coupling  
Handle for PKZM 0, PKZM 01 or PKZM  
4 Breaker

**CONTROL/POWER SOURCE:**  
RSO-IAR-M18



\*All unit measurements are L x W x H

# RSA-211

FOR USE WITH:

**Eaton/Cutler-Hammer  
Safety Switch**



## SPECIFICATIONS

**OPERATION:** Close/Trip

**WEIGHT:** 14.7 lbs.

**DIMENSIONS:**\* 15.5" x 7.2" x 8.0"

**COMPATIBLE WITH:** Heavy Duty Fusible, Non-Fusible Low-Voltage Safety Switch, 30 A (240, 600 V; 30, 60 A; NEMA 1, 3R; Three Pole; Single Throw)

**CONTROL/POWER SOURCE:**  
RSO-IAR-M18



# RSA-211A

FOR USE WITH:

**Cutler-Hammer/Eaton  
Safety Switch**

## SPECIFICATIONS

**OPERATION:** Close/Trip

**WEIGHT:** 15.2 lbs.

**DIMENSIONS:**\* 15.5" x 7.2" x 8.0"

**COMPATIBLE WITH:** Heavy Duty Fusible, Non-Fusible Low-Voltage Safety Switch (240, 600 V; 600, 800 A; NEMA 1, 3R; Three Pole; Single Throw)

**CONTROL/POWER SOURCE:**  
RSO-IAR-M18



# RSA-213A

FOR USE WITH:

**Metron  
Handle Operator**

## SPECIFICATIONS

**OPERATION:** Close/Trip

**WEIGHT:** 16.5 lbs.

**DIMENSIONS:**\* 26.1" x 8.5" x 9.2"

**COMPATIBLE WITH:** Fire Pump Controller Series M200, M300, M400, M420, M430, M435, M450, & M700 (with or without Transfer Switch, 200-480 V, 75-700 HP, Circuit Breaker Disconnect Operation Only)

**CONTROL/POWER SOURCE:**  
RSO-IAR-M18



\*All unit measurements are L x W x H

# RSA-217

FOR USE WITH:

**General Electric  
Air Circuit Breaker**

## SPECIFICATIONS

**OPERATION:** Trip

**WEIGHT:** 8.1 lbs.

**DIMENSIONS:**\* 12.1" x 4.8" x 5.4"

**COMPATIBLE WITH:** Type AMH, 1200-2000 A (includes AMH-4.76-100, 250, 350-0D, 1D)

**CONTROL/POWER SOURCE:**  
RSO-IAR-M18



# RSA-218A

FOR USE WITH:

**Federal Pacific Electric  
Air Circuit Breaker**



## SPECIFICATIONS

**OPERATION:** Close/Trip

**WEIGHT:** 12.0 lbs.

**DIMENSIONS:**\* 14.3" x 9.5" x 6.5"

**COMPATIBLE WITH:** Type FPS4/FPS5/  
FMS4/FMS5 30/50/75, 800-3200 A

**CONTROL/POWER SOURCE:**  
RSO-IAR-M18

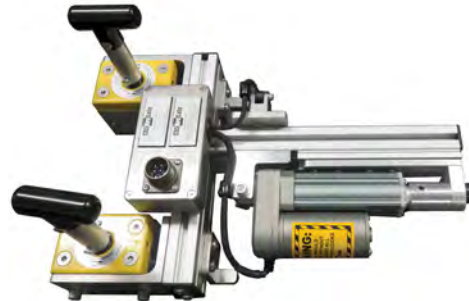

# RSA-221C

FOR USE WITH:

**Cutler-Hammer/Eaton  
Handle Operator**

## SPECIFICATIONS

**OPERATION:** Close/Trip

**WEIGHT:** 8.8 lbs.

**DIMENSIONS:**\* 11.9" x 8.7" x 6.7"

**COMPATIBLE WITH:** Type SM Safety  
Handle Mechanism for Series C Molded  
Case Circuit Breakers (MCCBs) - L Frame  
(includes SM600R & SM600L)

**CONTROL/POWER SOURCE:**  
RSO-IAR-M18



\*All unit measurements are L x W x H

# RSA-222

FOR USE WITH:

**Eaton/Cutler Hammer  
Flex Shaft Flange Mounted Handle**



## SPECIFICATIONS

**OPERATION:** Close/Trip

**WEIGHT:** 9.5 lbs.

**DIMENSIONS:**\* 14.0" x 7.4" x 7.7"

**COMPATIBLE WITH:** Flex Shaft Flange Mounted Handle Mechanism With 4" Operating Handle Length for Series C MCCB, Flush Mounted, includes G Frame F0SXX, F Frame F1SXX, J Frame F2SXX, K Frame F3SXX, L Frame and M Frame F4SXX, N Frame F5SXX, and R Frame F6SXX

**CONTROL/POWER SOURCE:** RSO-IAR-M18



# RSA-222D

FOR USE WITH:

**Eaton/Cutler-Hammer  
Flange Handle**



## SPECIFICATIONS

**OPERATION:** Close/Trip

**WEIGHT:** 11.0 lbs.

**DIMENSIONS:**\* 19.0" x 9.0" x 10.0"

**COMPATIBLE WITH:** Flex Shaft Flange Mounted Handle Mechanism With 4" Operating Handle Length for Series C MCCB, Recessed Mounted on Stainless Steel Enclosure, includes G Frame F0SXX, F Frame F1SXX, J Frame F2SXX, K Frame F3SXX, L Frame and M Frame F4SXX, N Frame F5SXX, and R Frame F6SXX

**CONTROL/POWER SOURCE:** RSO-IAR-M18



# RSA-222E

FOR USE WITH:

**Eaton/Cutler-Hammer  
Flange Handle**



## SPECIFICATIONS

**OPERATION:** Close/Trip

**WEIGHT:** 13.5 lbs.

**DIMENSIONS:**\* 14.0" x 7.4" x 8.2"

**COMPATIBLE WITH:** Flex Shaft Flange Mounted Handle Mechanism for Series C MCCB N Frame F5SXXC

**CONTROL/POWER SOURCE:** RSO-IAR-M18



\*All unit measurements are L x W x H

# RSA-224

FOR USE WITH:

**Eaton/Cutler-Hammer  
Bus Plug**

## SPECIFICATIONS

**OPERATION:** Close/Trip

**WEIGHT:** 8.0 lbs.

**DIMENSIONS:** 18.5" x 9.5" x 8.0"

**COMPATIBLE WITH:** Low-Voltage Pow-R-Way, Pow-R-Way II, Pow-R-Way III Busway System Plug-In Device, IPB-MC 100-200 A Bus Plug

**CONTROL/POWER SOURCE:**  
RSO-IAR-M18



# RSA-227

FOR USE WITH:

**Cutler-Hammer/Eaton  
Handle Operator**

## SPECIFICATIONS

**OPERATION:** Close/Trip

**WEIGHT:** 14.7 lbs.

**DIMENSIONS:**\* 11.8" x 6.8" x 7.6"

**COMPATIBLE WITH:** Universal Rotary Handle Mechanism for Series C & Series G MCCBs

**CONTROL/POWER SOURCE:**  
RSO-IAR-M18



# RSA-228

FOR USE WITH:

**Federal Pacific Electric  
Air Circuit Breaker**

## SPECIFICATIONS

**OPERATION:** Close/Trip

**WEIGHT:** 20.6 lbs.

**DIMENSIONS:**\* 15.3" x 12.4" x 9.5"

**COMPATIBLE WITH:** Low-Voltage Circuit Breaker 12, 16, 20, 32, 40PL for Non-Magnetic Switchgear

**CONTROL/POWER SOURCE:**  
RSO-IIID-M18



\*All unit measurements are L x W x H

# RSA-230B

FOR USE WITH:  
**Cutler-Hammer/Eaton  
Molded Case Circuit Breaker**

## SPECIFICATIONS

**OPERATION:** Close/Trip

**WEIGHT:** 15.0 lbs.

**DIMENSIONS:**\* 5.3" x 6.2" x 7.5"

**COMPATIBLE WITH:** Series G MCCB LG Frame 100-630 A, 240-600 V AC, 1, 2, 3, 4 Pole, Flush Mounted, includes LG, LGE, LGS, LGH, LGC, LGU, LGX

**CONTROL/POWER SOURCE:**  
RSO-IAR-M18



# RSA-233

FOR USE WITH:  
**Terasaki/Hyundai  
Air Circuit Breaker**

## SPECIFICATIONS

**OPERATION:** Charge/Close/Trip

**WEIGHT:** 16.1 lbs.

**DIMENSIONS:**\* 11.8" x 16.1" x 7.0"

**COMPATIBLE WITH:** Terasaki TemPower Type AT Low-Voltage Air Circuit Breaker, 630-4000 A & Hyundai Type HAT Low-Voltage Air Circuit Breaker, 630-5000 A

**CONTROL/POWER SOURCE:**  
RSO-IIID-M18



# RSA-233A

FOR USE WITH:  
**Terasaki/Hyundai  
Air Circuit Breaker**

## SPECIFICATIONS

**OPERATION:** Close/Trip

**WEIGHT:** 13.3 lbs.

**DIMENSIONS:**\* 13.0" x 15.6" x 7.0"

**COMPATIBLE WITH:** Terasaki TemPower Type AT Low-Voltage Air Circuit Breaker, 630-4000 A & Hyundai Type HAT Low-Voltage Air Circuit Breaker, 630-5000 A

**CONTROL/POWER SOURCE:**  
RSO-IIID-M18



\*All unit measurements are L x W x H

# RSA-242

FOR USE WITH:  
**ABB/SACE**  
**Air Circuit Breaker**



## SPECIFICATIONS

**OPERATION:** Charge/Close/Trip

**WEIGHT:** 19.0 lbs.

**DIMENSIONS:**\* 6.1" x 11.3" x 14.0"

**COMPATIBLE WITH:** For Novamax All

**CONTROL/POWER SOURCE:**  
RSO-IIID-M18



# RSA-243

FOR USE WITH:  
**General Electric**  
**Handle Operator**

## SPECIFICATIONS

**OPERATION:** Close/Trip

**WEIGHT:** 9.6 lbs.

**DIMENSIONS:**\* 18.8" x 9.0" x 7.3"

**COMPATIBLE WITH:** SE100CS, TE100CS Breaker Switch NEMA Type 4, 4X Enclosure. For Use with TE-Series (TEB, TED, THED, & TEC) Breakers and SE Series (SEDA, SEHA, SELA, & SEPA) Breakers.

**CONTROL/POWER SOURCE:**  
RSO-IAR-M18



# RSA-243A

FOR USE WITH:  
**General Electric**  
**Handle Operator**

## SPECIFICATIONS

**OPERATION:** Close/Trip

**WEIGHT:** 11.5 lbs.

**DIMENSIONS:**\* 31.8" x 14.8" x 7.3"

**COMPATIBLE WITH:** SG400CS Breaker Switch NEMA Type 4, 4X Enclosure. For Use with Spectra G Series Breakers

**CONTROL/POWER SOURCE:**  
RSO-IAR-M18



\*All unit measurements are L x W x H

# RSA-244

FOR USE WITH:

**Motortronics**  
**Medium-Voltage Soft Starter**

## SPECIFICATIONS

OPERATION: Close/Trip

WEIGHT: 23.0 lbs.

DIMENSIONS:\* 21.0" x 6.5" x 7.0"

COMPATIBLE WITH: MVC Plus, Overall Handle Length 7"

CONTROL/POWER SOURCE:  
RSO-IAR-M18



# RSA-244A

FOR USE WITH:

**Motortronics**  
**Medium-Voltage Soft Starter**

## SPECIFICATIONS

OPERATION: Close/Trip

WEIGHT: 24.0 lbs.

DIMENSIONS:\* 26.0" x 7.0" x 9.5"

COMPATIBLE WITH: MVC Plus, Overall Handle Length 14.125"

CONTROL/POWER SOURCE:  
RSO-IAR-M18



# RSA-247

FOR USE WITH:

**R&IE**  
**Load Interrupter Switch**

## SPECIFICATIONS

OPERATION: Close/Trip

WEIGHT: 39.2 lbs.

DIMENSIONS:\* 23.1" x 23.0" x 12.5"

COMPATIBLE WITH: Load Interrupter Switch

CONTROL/POWER SOURCE:  
RSO-IAR-M18



\*All unit measurements are L x W x H

# RSA-249

FOR USE WITH:

**S&C**  
**Load Interrupter Switch**

## SPECIFICATIONS

**OPERATION:** Charge/Close/Trip

**WEIGHT:** 45.2 lbs.

**DIMENSIONS:**\* (2) Piece Assembly

Trip Assembly: 8.4" x 26.2" x 10.3"  
Charge/Close Assembly: 20.0" x 8.0" x 8.0"

**COMPATIBLE WITH:** Type MS Medium-Voltage Load Interrupter Switch

**CONTROL/POWER SOURCE:**  
RSO-IIID-M18



# RSA-250

FOR USE WITH:

**Merlin Gerin**  
**Molded Case Circuit Breaker**

## SPECIFICATIONS

**OPERATION:** Charge/Close/Trip

**WEIGHT:** 2.5 lbs.

**DIMENSIONS:**\* 8.7" x 9.2" x 9.7"

**COMPATIBLE WITH:** Compact NS (includes SF250, 15-250 A)

**CONTROL/POWER SOURCE:**  
RSO-IIID-M18



# RSA-251

FOR USE WITH:

**Schneider Electric/Square D**  
**Handle Operator**

## SPECIFICATIONS

**OPERATION:** Close/Trip

**WEIGHT:** 13.6 lbs.

**DIMENSIONS:**\* 5.0" x 10.6" x 7.5"

**COMPATIBLE WITH:** Blockset Rotary Handle Actuator (Small)

**CONTROL/POWER SOURCE:**  
RSO-IAR-M18



\*All unit measurements are L x W x H

# RSA-252

FOR USE WITH:

**L&T**  
**Handle Operator**

## SPECIFICATIONS

OPERATION: Close/Trip

WEIGHT: 15.4 lbs.

DIMENSIONS:\* 10.8" x 7.7" x 8.4"

COMPATIBLE WITH: DN2 MCCB  
Rotary Handle Actuator

CONTROL/POWER SOURCE:  
RSO-IAR-M18



# RSA-252A

FOR USE WITH:

**L&T**  
**Handle Operator**

## SPECIFICATIONS

OPERATION: Close/Trip

WEIGHT: 15.9 lbs.

DIMENSIONS:\* 8.3" x 14.6" x 7.6"

COMPATIBLE WITH: DSINE ROH DM  
Rotary Handle Actuator (Size 2)

CONTROL/POWER SOURCE:  
RSO-IAR-M18



# RSA-265A

FOR USE WITH:

**Eaton/Cutler-Hammer**  
**Insulated Case Circuit Breaker**

## SPECIFICATIONS

OPERATION: Close/Trip

WEIGHT: 18.0 lbs.

DIMENSIONS:\* 25.0" x 15.0" x 8.2"

COMPATIBLE WITH: Type NRX NF Frames  
200-1200 A and IEC IZMX16 630 A, 800 A,  
1000 A, 1250 A, and 1600 A

CONTROL/POWER SOURCE:  
RSO-IIID-M18



\*All unit measurements are L x W x H

# RSA-265B

FOR USE WITH:

**Eaton/Cutler-Hammer  
Insulated Case Circuit Breaker**



## SPECIFICATIONS

**OPERATION:** Charge/Close/Trip

**WEIGHT:** 4.5 lbs.

**DIMENSIONS:**\* 8.5" x 6.5" x 5.8"

**COMPATIBLE WITH:** Type NRX RF Frames 1600-3000 A and IEC IZMX16 800 A, 1000 A, 1250 A, 1600 A, 2000 A, 2500 A, 3200 A, 4000 A

**CONTROL/POWER SOURCE:**  
RSO-IIID-M18



# RSA-267

FOR USE WITH:

**S&C  
Transformer**



## SPECIFICATIONS

**OPERATION:** Close/Trip

**WEIGHT:** 22.0 lbs.

**DIMENSIONS:**\* 15.6" x 7.8" x 8.3"

**COMPATIBLE WITH:** PMH-9/PME Pad Mounted Mini-Rupter Switch, Old and New Types of Indicators

**CONTROL/POWER SOURCE:**  
RSO-IAR-M18



# RSA-269

FOR USE WITH:

**ABB/ITE/BBC  
Air Circuit Breaker**



## SPECIFICATIONS

**OPERATION:** Close/Trip

**WEIGHT:** 12.0 lbs.

**DIMENSIONS:**\* 13.9" x 7.4" x 5.0"

**COMPATIBLE WITH:** HK Style with Hook Latch Close and Push Button Trip, HK/VHK Breakers with Close and Trip Operations Right Beside Each Other Only

**CONTROL/POWER SOURCE:**  
RSO-IAR-M18



\*All unit measurements are L x W x H

# RSA-270

FOR USE WITH:

**Eaton/Cutler-Hammer/Westinghouse  
Safety Switch**



## SPECIFICATIONS

**OPERATION:** Close/Trip

**WEIGHT:** 13.09 lbs.

**DIMENSIONS:**\* 21.5" x 5.5" x 7.3"

**COMPATIBLE WITH:** Type JLDN600, RLDN600, WLDN600, JNDN1200, RNDN1200, and WNDN1200 Circuit Breaker Enclosures, 600-1200 A. Not for Stainless Steel Enclosures.

**CONTROL/POWER SOURCE:**

RSO-IAR-M18



# RSA-270B

FOR USE WITH:

**Eaton/Cutler-Hammer/Westinghouse  
Safety Switch**



## SPECIFICATIONS

**OPERATION:** Close/Trip

**WEIGHT:** 15.0 lbs.

**DIMENSIONS:**\* 18.0" x 7.0" x 9.8"

**COMPATIBLE WITH:** HF361, HF322 Circuit Breaker Enclosure With Raised Face, Large Rubberized Handle, 100 A

**CONTROL/POWER SOURCE:**

RSO-IAR-M18

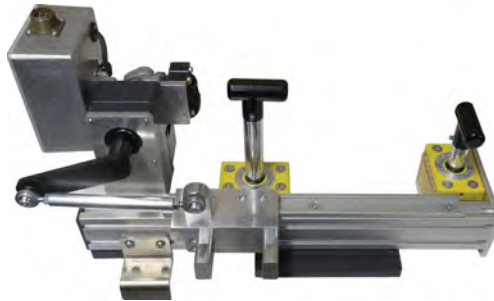

# RSA-271

FOR USE WITH:

**Eaton/Cutler-Hammer  
Rotary Handle**



## SPECIFICATIONS

**OPERATION:** Close/Trip

**WEIGHT:** 15.0 lbs.

**DIMENSIONS:**\* 11.0" x 9.0" x 6.9"

**COMPATIBLE WITH:** S01 Universal Rotary Handle

**CONTROL/POWER SOURCE:**

RSO-IAR-M18



\*All unit measurements are L x W x H

# RSA-271A

FOR USE WITH:

**Eaton/Cutler-Hammer  
Rotary Handle**



## SPECIFICATIONS

**OPERATION:** Close/Trip

**WEIGHT:** 33.0 lbs.

**DIMENSIONS:**\* 18.5" x 9.92" x 9.7"

**COMPATIBLE WITH:** G-EG/JG/LG  
Universal Rotary Handle

**CONTROL/POWER SOURCE:**  
RSO-IAR-M18



# RSA-272

FOR USE WITH:

**Cooper  
Load Interrupt Switch**



## SPECIFICATIONS

**OPERATION:** Close/Trip

**WEIGHT:** 39.0 lbs.

**DIMENSIONS:**\* 33.3" x 12.3" x 9.0"

**COMPATIBLE WITH:** Type CM Fault  
Interrupter

**CONTROL/POWER SOURCE:**  
RSO-IAR-M18

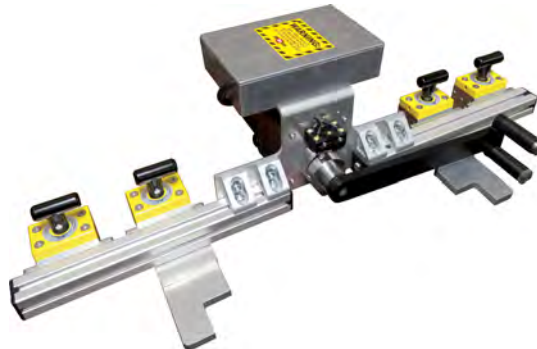

# RSA-275

FOR USE WITH:

**Square D  
Transfer Switch**



## SPECIFICATIONS

**OPERATION:** Close/Trip

**WEIGHT:** 30.0 lbs.

**DIMENSIONS:**\* 40.0" x 9.1" x 7.9"

**COMPATIBLE WITH:** Class 9810 Series  
Type TS Three-Position Switch

**CONTROL/POWER SOURCE:**  
RSO-IAR-M18



\*All unit measurements are L x W x H

# RSA-276

FOR USE WITH:  
**Gould/ITE  
Molded Case Circuit Breaker**



## SPECIFICATIONS

OPERATION: Close/Trip  
WEIGHT: 23.0 lbs.  
DIMENSIONS:\* 18.6" x 10.0" x 9.2"  
COMPATIBLE WITH: HS3B MCCB  
2500 A and Above  
CONTROL/POWER SOURCE:  
RSO-IAR-M18



# RSA-277

FOR USE WITH:  
**Challenger  
Safety Switch**



## SPECIFICATIONS

OPERATION: Close/Trip  
WEIGHT: 25.0 lbs.  
DIMENSIONS:\* 21.2" x 8.3" x 11.2"  
COMPATIBLE WITH: HDN365 Safety  
Switch 400 A  
CONTROL/POWER SOURCE:  
RSO-IAR-M18



# RSA-278

FOR USE WITH:  
**Continental  
Motor Control Center**



## SPECIFICATIONS

OPERATION: Close/Trip  
WEIGHT: 20.0 lbs.  
DIMENSIONS:\* 9.6" x 8.5" x 9.5"  
COMPATIBLE WITH: LVMCC Size 1-4  
Close/Trip Actuator, Small Handle  
CONTROL/POWER SOURCE:  
RSO-IAR-M18



\*All unit measurements are L x W x H

# RSA-279

FOR USE WITH:  
**Eaton/Moeller  
Rotary Handle**



## SPECIFICATIONS

**OPERATION:** Close/Trip

**WEIGHT:** 20.0 lbs.

**DIMENSIONS:**\* 15.0" x 7.2" x 8.6"

**COMPATIBLE WITH:** NZM4 Door Coupling Rotary Handle, N4 Radius 137 mm for Arm From Center of Rotation, Through-the-Door Handle Operator, Black/Red Plastic Handle With White Insert Inside Handle, Square Base in 85 mm Square With 60° of Movement Between Close and Reset

**CONTROL/POWER SOURCE:**  
RSO-IAR-M18



# RSA-280

FOR USE WITH:  
**TornaTech  
Fire Pump Controller**



## SPECIFICATIONS

**OPERATION:** Close/Trip

**WEIGHT:** 13.0 lbs.

**DIMENSIONS:**\* 23.0" x 6.0" x 7.8"

**COMPATIBLE WITH:** GP Series Fire Pump Controller

**CONTROL/POWER SOURCE:**  
RSO-IAR-M18



# RSA-281

FOR USE WITH:  
**Nelson Electric/Sola Basic Industries/ISB  
Rotary Handle**



## SPECIFICATIONS

**OPERATION:** Close/Trip

**WEIGHT:** 18.0 lbs.

**DIMENSIONS:**\* 20.6" x 7.8" x 8.7"

**COMPATIBLE WITH:** Class 1035E LVMCC Rotary Handle Operator

**CONTROL/POWER SOURCE:**  
RSO-IAR-M18



\*All unit measurements are L x W x H

# RSA-282

FOR USE WITH:

**Bentek  
Rotary Handle**



## SPECIFICATIONS

OPERATION: Close/Trip

WEIGHT: 19.0 lbs.

DIMENSIONS:\* 15.6" x 7.3" x 9.3"

COMPATIBLE WITH: Bentek 1500 V UTS2 for 1500 VDC Integrated Disconnect String Combiner for Grounded PV Systems, 200-400 A

CONTROL/POWER SOURCE: RSO-IAR-M18



# RSA-283

FOR USE WITH:

**ABB  
Vacuum Retrofit Breaker**



## SPECIFICATIONS

OPERATION: Close/Trip

WEIGHT: 25.0 lbs.

DIMENSIONS:\* 21.5" x 10.8" x 8.9"

COMPATIBLE WITH: ADVAC or RMVAC MV Retrofit for 5 or 15 kV Breakers, Trip Actuator Only For Use in Manual Trip Rotary Location

CONTROL/POWER SOURCE: RSO-IAR-M18



# RSA-286

FOR USE WITH:

**Siemens  
Molded Case Circuit Breaker**



## SPECIFICATIONS

OPERATION: Close/Trip

WEIGHT: 10.0 lbs.

DIMENSIONS:\* 10.1" x 4.5" x 8.6"

COMPATIBLE WITH: 3VA64 Series MCCB 450, 500, 600 A Frame Sizes

CONTROL/POWER SOURCE: RSO-IAR-M18



\*All unit measurements are L x W x H

# RSA-287

FOR USE WITH:  
**ABB/SACE**  
**Molded Case Circuit Breaker**



## SPECIFICATIONS

**OPERATION:** Charge/Close/Trip

**WEIGHT:** 10.0 lbs.

**DIMENSIONS:**\* 10.8" x 4.5" x 10.5"

**COMPATIBLE WITH:** Tmax XT1 Frame, 125 A, Flush Mounted

**CONTROL/POWER SOURCE:** RSO-IAR-M18

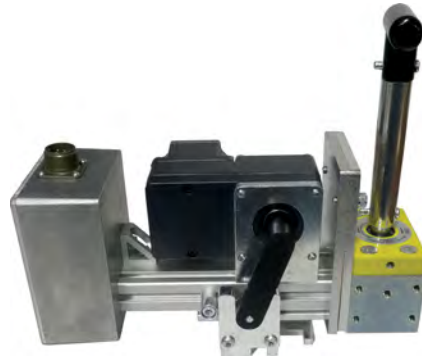

# RSA-287D

FOR USE WITH:  
**ABB/SACE**  
**Molded Case Circuit Breaker**



## SPECIFICATIONS

**OPERATION:** Close/Trip

**WEIGHT:** 19.0 lbs.

**DIMENSIONS:**\* 18.2" x 9.3" x 10.1"

**COMPATIBLE WITH:** Tmax XT5 Frame, 400-600 A, Flush Mounted

**CONTROL/POWER SOURCE:** RSO-IAR-M18



# RSA-287E

FOR USE WITH:  
**ABB/SACE**  
**Molded Case Circuit Breaker**



## SPECIFICATIONS

**OPERATION:** Close/Trip

**WEIGHT:** 17.0 lbs.

**DIMENSIONS:**\* 17.3" x 9.3" x 10.1"

**COMPATIBLE WITH:** Tmax XT6 Frame, Withdrawable MCCB, 800 A, Flush Mounted

**CONTROL/POWER SOURCE:** RSO-IAR-M18



\*All unit measurements are L x W x H

# RSA-288

FOR USE WITH:  
**Mitsubishi  
Rotary Handle**



## SPECIFICATIONS

OPERATION: Close/Trip

WEIGHT: 9.0 lbs.

DIMENSIONS:\* 10.4" x 6.8" x 6.5"

COMPATIBLE WITH: WS-V Series Rotary Handle, 62 mm Diameter, 30-250 A Frame Size, F-05SV2, F-05SV2E2, F-05SV, F-05SVE, F-1SV, F-1SVE, F-1UV, F-1UVE, F-2SV, F-2SVE, F-2UV, V-2UVE, F-1SVUL, F-2SVUL, F-03SVUL2, F-03SVUL, F-05SVUL2, F-05SVUL, F-2SUL Handle Styles

CONTROL/POWER SOURCE:

RSO-IAR-M18



# RSA-289

FOR USE WITH:  
**UNELEC/Sylvania  
Air Circuit Breaker**



## SPECIFICATIONS

OPERATION: Charge/Close/Trip

WEIGHT: 20.0 lbs.

DIMENSIONS:\* 16.5" x 9.8" x 9.4"

COMPATIBLE WITH: CNX LVACB with Charging Handle

CONTROL/POWER SOURCE:

RSO-IIID-M18



# RSA-292

FOR USE WITH:  
**EBG  
Disconnect Switch**



## SPECIFICATIONS

OPERATION: Close/Trip

WEIGHT: 32.0 lbs.

DIMENSIONS:\* 13.3" x 8.8" x 14.7"

COMPATIBLE WITH: Disconnect Switch, Rotary

CONTROL/POWER SOURCE:

RSO-IAR-M18



\*All unit measurements are L x W x H

# RSA-293

FOR USE WITH:  
**GEC Alsthom  
Load Break Switch**



## SPECIFICATIONS

**OPERATION:** Close/Trip  
**WEIGHT:** 17.0 lbs.  
**DIMENSIONS:\*** 14.2" x 6.5" x 11.5"  
**COMPATIBLE WITH:** Load Break Switch, Rotary  
**CONTROL/POWER SOURCE:** RSO-IAR-M18



# RSA-294

FOR USE WITH:  
**Elmex  
Fixed Disconnect Handle Operator**



## SPECIFICATIONS

**OPERATION:** Close/Trip  
**WEIGHT:** 17.0 lbs.  
**DIMENSIONS:\*** 13.0" x 11.0" x 9.6"  
**COMPATIBLE WITH:** Disconnect Switch, Rotary 180-270°  
**CONTROL/POWER SOURCE:** RSO-IIID-M18



# RSA-295

FOR USE WITH:  
**Elmex  
Load Break Switch**



## SPECIFICATIONS

**OPERATION:** Close/Trip  
**WEIGHT:** 40.0 lbs.  
**DIMENSIONS:\*** 32.6" x 12.8" x 10.4"  
**COMPATIBLE WITH:** Load Break Switch, Lever Style  
**CONTROL/POWER SOURCE:** RSO-IAR-M18

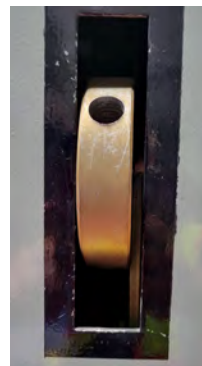





# Remote Switching Solutions for Pad-Mounted Transformers

## The RSK-PMT Solution

The CBS ArcSafe® RSK-PMT with CDS kit is a remote switch kit (RSK) for pad-mounted transformer (PMT) applications. The kit includes a closed-door switching (CDS) modification for remote operations without the need to open PMT doors for switching tasks.

Remote switching mechanisms provide arc-flash safety for work with PMTs in **applications such as wind farms, facilities management, solar, and utility distribution**. The kit includes the RSA-216 remote switch actuator, the RSO-IV-M18 remote switch operator module with a 12-foot operating cable and radio remote, an exterior-mounted auxiliary enclosure with an interior alignment tube that can be installed in as little as 30 minutes, and a 2-inch fiberglass hot stick with custom switch connection and customizable switch adapters.

## Why Do Transformers Need Remote Switching?

- Incident energy is proportional to current and time/speed.
- Higher current is typically found on the low-voltage (LV) side of the transformer, where there may also be high incident energy.
- Opening the LV side to access the switch exposes the worker to high incident energy without coverings in place.
- Faults can occur due to a variety of conditions that are not a part of normal operations.

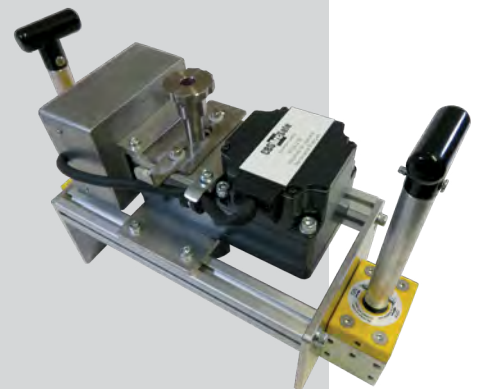

# RSK-PMT



**EC&M.**  
**Product of the Year**  
2023 Category Winner



## 5 Steps to Safe Transformer Maintenance

1. Insert the hot stick adapter and feel for a secure connection with the PMT switch.\*



RSA-216 remote switch actuator

Multiple installed auxiliary enclosures with alignment tubes and customized hot stick for transformers



2. Retrieve the portable motorized RSK actuator.

RSO-IV-M18 remote switch operator



3. Attach the RSA actuator with magnets.



4. Connect the unit cable and power on the RSO-IV-M18.

5. Move to a safe distance for switching with the radio remote.



## Scan the QR code for pricing and demos

The RSK-PMT comes with a one-year warranty and is available in some cases within days. Learn more and ask for pricing and demos through the QR code or call us at **877-4-SAFETY**.

\*The CBS ArcSafe RSK-PMT system is used in conjunction with U.S. Patent 11,646,168 B2 shown in the photos herein.

# Remote Switch Kits



CBS ArcSafe Chicken Switch® remote switch kits (RSKs) are designed to remotely operate (close/trip) select models of circuit breakers and motor control centers. Offering maximum portability, the lightweight RSK products differ from other CBS ArcSafe products by providing complete kits that include a handheld controller, batteries, control cable, actuator, and a customized Pelican® brand carrying case.

CBS ArcSafe acquired the RSK product line following the acquisition of Martek Limited, the manufacturer of the Chicken Switch® brand of remote switching and remote racking products.

## OPTIONAL FEATURES

- 30 ft. (standard) or 50 ft. control cables
- Extra cables available
- Wireless remote control available on select models

## BENEFITS

- The RSK shares many of the same benefits as the RSA. However, the RSK does not require an RSO to operate.

**RSK-CS01W**



**RSK-GEPB1L**



**RSK-PMT**



**RSK-CS01**



**RSK-K15**



Compatible with all switchgear manufacturers, including:

- |                        |                           |                             |                       |
|------------------------|---------------------------|-----------------------------|-----------------------|
| ■ <b>ABB/BBC/ITE</b>   | ■ <b>Electroswitch</b>    | ■ <b>SACE</b>               | ■ <b>Square D</b>     |
| ■ <b>Allen-Bradley</b> | ■ <b>General Electric</b> | ■ <b>Schneider Electric</b> | ■ <b>Westinghouse</b> |
| ■ <b>Cutler-Hammer</b> | ■ <b>ITI</b>              | ■ <b>Shalloco</b>           |                       |
| ■ <b>Eaton</b>         | ■ <b>Merlin Gerin</b>     | ■ <b>Siemens</b>            |                       |

NOTE: All manufacturers' names, trademarks, and part numbers are used for reference purposes only. CBS ArcSafe, Inc., is not an authorized distributor or representative of manufacturers shown. Designated trademarks, brand names, and brands appearing herein are the property of their respective owners.

The CBS ArcSafe RSK-PMT system is used in conjunction with U.S. Patent 11,646,168 B2 shown in the photos herein.

\*All unit measurements are L x W x H

# RSK-ABL1W

FOR USE WITH:  
**Allen-Bradley  
Motor Control Center**

## SPECIFICATIONS

**OPERATION:** On/Off MCC Handle Operator

**WEIGHT:** 8.1 lbs.

**DIMENSIONS:**\* 9.5" x 7.8" x 6.1"

**COMPATIBLE WITH:** 2100 CENTERLINE Series and Bulletin 1200 Series MCC Sizes 1-4

**BATTERY SOURCE:** Handheld Controller/Milwaukee M18 REDLITHIUM Ion Battery Pack



Cabled version also available.

# RSK-ABL2W

FOR USE WITH:  
**Allen-Bradley  
Motor Control Center**

## SPECIFICATIONS

**OPERATION:** On/Off MCC Handle Operator

**WEIGHT:** 12.3 lbs.

**DIMENSIONS:**\* 12.5" x 9.4" x 3.6"

**COMPATIBLE WITH:** 2100 CENTERLINE and Bulletin 1200 Series MCC Main Buckets with Large Handles

**BATTERY/POWER SOURCE:** Handheld Controller/Milwaukee M18 REDLITHIUM Ion Battery Pack



Cabled version also available.

# RSK-ABL3W

FOR USE WITH:  
**Allen-Bradley  
Motor Control Center**

## SPECIFICATIONS

**OPERATION:** On/Off MCC Handle Operator

**WEIGHT:** 11.9 lbs.

**DIMENSIONS:**\* 13.3" x 7.5" x 5.3"

**COMPATIBLE WITH:** CENTERLINE 1500 Series 5 kV Starter; Current Generation with Red/Black Handle

**BATTERY/POWER SOURCE:** Handheld Controller/Milwaukee M18 REDLITHIUM Ion Battery Pack

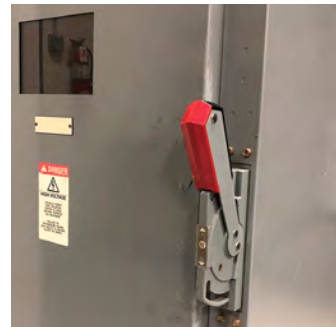

Cabled version also available.

\*All unit measurements are L x W x H

# RSK-AK11

FOR USE WITH:  
**General Electric  
Air Circuit Breaker**

## SPECIFICATIONS

**OPERATION:** Push-Button Close/Trip Operator

**WEIGHT:** 1.7 lbs.

**DIMENSIONS:**\* 7.8" x 2.3" x 4.5"

**COMPATIBLE WITH:** Type AKR-6, 10D-30, 50 & AKR-4, 5-B-30, 50 (Recessed Face, Horizontal Trip/Close, May or May Not Have Charging Handle). Requires Bracket.

**BATTERY/POWER SOURCE:** AA Batteries



# RSK-AK12

FOR USE WITH:  
**General Electric  
Air Circuit Breaker**

## SPECIFICATIONS

**OPERATION:** Push-Button Close/Trip Operator

**WEIGHT:** 2.5 lbs.

**DIMENSIONS:**\* 11.5" x 8.0" x 3.5"

**COMPATIBLE WITH:** Type AKR-6/10D-75/100 (Protruding Breaker Face, No Charge Handle, Vertical Trip/Close Buttons)

**BATTERY/POWER SOURCE:** AA Batteries



# RSK-AK13

FOR USE WITH:  
**General Electric  
Air Circuit Breaker**

## SPECIFICATIONS

**OPERATION:** Push-Button Close/Trip Operator

**WEIGHT:** 2.4 lbs.

**DIMENSIONS:**\* 7.3" x 7.6" x 5.1"

**COMPATIBLE WITH:** Type AK, 1600-3200 A (Blue Face with Vertically Aligned Trip/Close Buttons)

**BATTERY/POWER SOURCE:** AA Batteries



\*All unit measurements are L x W x H

# RSK-AK14

FOR USE WITH:

**General Electric  
Air Circuit Breaker**

## SPECIFICATIONS

**OPERATION:** Push-Button Close/Trip Operator

**WEIGHT:** 3.1 lbs.

**DIMENSIONS:**\* 8.8" x 4.8" x 6.5"

**COMPATIBLE WITH:** Type AKR, 800-2000 A (includes AKR/AKRT/AKRU - 4A/4B/5A/5B-30/30H/50/50H)

**BATTERY/POWER SOURCE:** AA Batteries



# RSK-BBC5

FOR USE WITH:

**ABB/BBC/ITE  
Air Circuit Breaker**

## SPECIFICATIONS

**OPERATION:** Push-Button Close/Trip Operator

**WEIGHT:** 2.5 lbs.

**DIMENSIONS:**\* 5.5" x 1.7" x 4.0"

**COMPATIBLE WITH:** Type LK25 2500 A

**BATTERY/POWER SOURCE:** AA Batteries



# RSK-BL30W

FOR USE WITH:

**Square D/GTE/Sylvania  
Bolted Pressure Switch**

## SPECIFICATIONS

**OPERATION:** Close/Trip Lever Operator

**WEIGHT:** 3.8 lbs.

**DIMENSIONS:**\* 8.0" x 7.5" x 3.5"

**COMPATIBLE WITH:** Type BL, BLH, Single Pole (10-70 A)

**BATTERY/POWER SOURCE:** Handheld Controller/Milwaukee M18 REDLITHIUM Ion Battery Pack

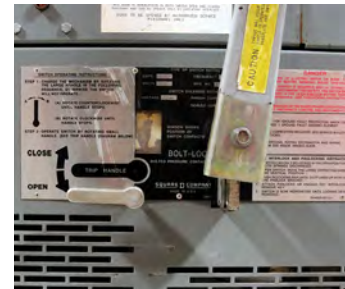

Cabled version also available. Runs on AA batteries.

\*All unit measurements are L x W x H

# RSK-CHL1W

FOR USE WITH:

**Eaton/Cutler-Hammer/Westinghouse  
Motor Control Center**

## SPECIFICATIONS

**OPERATION:** On/Off MCC Handle Operator

**WEIGHT:** 7.4 lbs.

**DIMENSIONS:**\* 9.9" x 8.5" x 7.0"

**COMPATIBLE WITH:** 2100/Freedom/Five Star/Advantage Series LVMCC Sizes 1-4 Buckets

**BATTERY/POWER SOURCE:** Handheld Controller/Milwaukee M18 REDLITHIUM Ion Battery Pack

Cabled version also available.

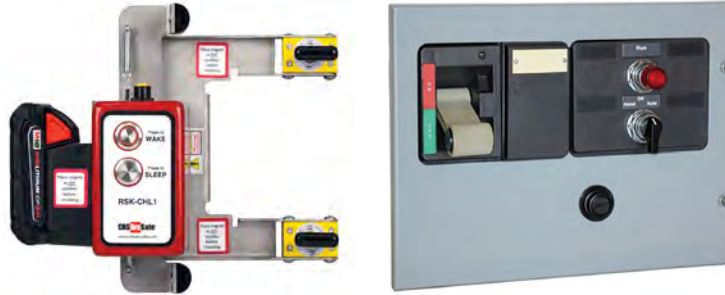

# RSK-CS01W

FOR USE WITH:

**Electroswitch/General Electric/  
Westinghouse/ITI/Shallco  
Control Switch**



## SPECIFICATIONS

**OPERATION:** Close/Trip Control Switch Operator (for Pistol-Grip Handles)

**WEIGHT:** 2.8 lbs.

**DIMENSIONS:**\* 7.5" x 4.8" x 4.3"

**COMPATIBLE WITH:** Electroswitch Series 24, 24P, General Electric SB, SBM, SB-1, SB-9, SB-10, Westinghouse Type W, Shallco Series 26

**BATTERY/POWER SOURCE:** Handheld Controller/Milwaukee M18 REDLITHIUM Ion Battery Pack

Cabled version also available. Runs on AA batteries.



# RSK-CS03W

FOR USE WITH:

**ITI Control Switch**

## SPECIFICATIONS

**OPERATION:** Close/Trip Control Switch Operator (for Pistol-Grip Handles)

**WEIGHT:** 2.8 lbs.

**DIMENSIONS:**\* 7.5" x 6.3" x 5.0"

**COMPATIBLE WITH:** Series 95 with Large Escutcheon Plate

**BATTERY/POWER SOURCE:** Handheld Controller/Milwaukee M18 REDLITHIUM Ion Battery Pack

Cabled version also available. Runs on AA batteries.



\*All unit measurements are L x W x H

# RSK-CS04W

FOR USE WITH:

**General Electric/Westinghouse  
Control Switch**

## SPECIFICATIONS

**OPERATION:** Close/Trip Control Switch Operator (for Pistol-Grip Handles)

**WEIGHT:** 2.7 lbs.

**DIMENSIONS:**\* 7.3" x 4.3" x 4.8"

**COMPATIBLE WITH:** General Electric SB-1, SB-9, SB-10, Westinghouse Type W

**BATTERY/POWER SOURCE:** Handheld Controller/Milwaukee M18 REDLITHIUM Ion Battery Pack

Cabled version also available. Runs on AA batteries.



# RSK-CS05

FOR USE WITH:

**Electroswitch  
Control Switch**

## SPECIFICATIONS

**OPERATION:** Close/Trip Control Switch Operator (for Pistol-Grip Handles)

**WEIGHT:** 1.9 lbs.

**DIMENSIONS:**\* 6.1" x 3.1" x 4.0"

**COMPATIBLE WITH:** Series 20 Control Switch

**BATTERY/POWER SOURCE:** AA Batteries



# RSK-CS06

FOR USE WITH:

**Cutler-Hammer  
Control Switch**

## SPECIFICATIONS

**OPERATION:** Close/Trip Control Switch Operator (for Pistol-Grip Handles)

**WEIGHT:** 2.7 lbs.

**DIMENSIONS:**\* 7.5" x 5.4" x 4.0"

**COMPATIBLE WITH:** Model L2R120CW Control Switch

**BATTERY/POWER SOURCE:** AA Batteries



\*All unit measurements are L x W x H

# RSK-CS07

FOR USE WITH:  
**Electroswitch  
Control Switch**

## SPECIFICATIONS

**OPERATION:** Close/Trip Control Switch Operator (for pistol-grip handles)

**WEIGHT:** 2.7 lbs.

**DIMENSIONS:**\* 7.5" x 4.5" x 4.3"

**COMPATIBLE WITH:** Series 31 Control Switch Common on Siemens RL Switchgear

**BATTERY/POWER SOURCE:** AA Batteries



# RSK-DS10

FOR USE WITH:  
**Cutler-Hammer/Square D/  
Westinghouse Air Circuit Breaker**

## SPECIFICATIONS

**OPERATION:** Push-Button Close/Trip Operator

**WEIGHT:** 4.1 lbs.

**DIMENSIONS:**\* 11.8" x 6.3" x 4.0"

**COMPATIBLE WITH:** Type DS - All

**BATTERY/POWER SOURCE:** AA Batteries



# RSK-GEPB1

FOR USE WITH:  
**General Electric  
Air Circuit Breaker**

## SPECIFICATIONS

**OPERATION:** Push-Button Close/Trip Operator

**WEIGHT:** 3.7 lbs.

**DIMENSIONS:**\* 8.8" x 7.0" x 4.8"

**COMPATIBLE WITH:** Power Break with Close Button on Upper Right Side of Charging Handle

**BATTERY/POWER SOURCE:** AA Batteries



\*All unit measurements are L x W x H

# RSK-GEPB1E

FOR USE WITH:

**General Electric  
Air Circuit Breaker**

## SPECIFICATIONS

**OPERATION:** Push-Button Close/Trip Operator

**WEIGHT:** 3.6 lbs.

**DIMENSIONS:**\* 8.8" x 7.0" x 4.8"

**COMPATIBLE WITH:** Power Break with Close Button in Top Center of Breaker Above Charging Handle

**BATTERY/POWER SOURCE:** AA Batteries



# RSK-GEPB1L

FOR USE WITH:

**General Electric  
Air Circuit Breaker**

## SPECIFICATIONS

**OPERATION:** Push-Button Close/Trip Operator

**WEIGHT:** 3.5 lbs.

**DIMENSIONS:**\* 8.8" x 7.0" x 4.8"

**COMPATIBLE WITH:** Power Break with Close Button on Left Side of Charging Handle

**BATTERY/POWER SOURCE:** AA Batteries



# RSK-GEPB2

FOR USE WITH:

**General Electric  
Air Circuit Breaker**

## SPECIFICATIONS

**OPERATION:** Push-Button Close/Trip Operator

**WEIGHT:** 1.9 lbs.

**DIMENSIONS:**\* 7.3" x 3.0" x 7.0"

**COMPATIBLE WITH:** Power Break II

**BATTERY/POWER SOURCE:** AA Batteries



\*All unit measurements are L x W x H

# RSK-iMPB1

FOR USE WITH:  
**E+I Engineering  
Control Switch**

## SPECIFICATIONS

**OPERATION:** Handle Operator

**WEIGHT:** 20.0 lbs.

**DIMENSIONS:**\* 19.2" x 15.2" x 7.3"

**COMPATIBLE WITH:** Intelligent Medium Powerbar Tap-off Disconnect Box Switch Type W-2

**BATTERY/POWER SOURCE:**  
Handheld Controller/Milwaukee M18 REDLITHIUM Ion Battery Pack



# RSK-K15

FOR USE WITH:  
**ABB/BBC/ITE  
Air Circuit Breaker**

## SPECIFICATIONS

**OPERATION:** Push-Button Close/Trip Operator

**WEIGHT:** 3.2 lbs.

**DIMENSIONS:**\* 14.1" x 7.3" x 6.8"

**COMPATIBLE WITH:** K-Line 2000 A and Below, Electrically Operated

**BATTERY/POWER SOURCE:**  
AA Batteries



# RSK-K20

FOR USE WITH:  
**ABB/BBC/ITE  
Air Circuit Breaker**

## SPECIFICATIONS

**OPERATION:** Push-Button Close/Trip Operator

**WEIGHT:** 5.5 lbs.

**DIMENSIONS:**\* 15.5" x 8.8" x 7.3"

**COMPATIBLE WITH:** K-Line 3000 A and Above, Electrically Operated

**BATTERY/POWER SOURCE:**  
AA Batteries



\*All unit measurements are L x W x H

# RSK-LA12

FOR USE WITH:

**Allis-Chalmers/Siemens-Allis  
Air Circuit Breaker**

## SPECIFICATIONS

**OPERATION:** Push-Button Close/Trip Operator

**WEIGHT:** 4.4 lbs.

**DIMENSIONS:**\* 14.8" x 3.6" x 5.6"

**COMPATIBLE WITH:** Type LA, LAF, 1600-2000 A (includes LA, LAF - 1600, 1600 A, 1600 AF, 1600B, 2000, 2000 A)

**BATTERY/POWER SOURCE:**  
AA Batteries

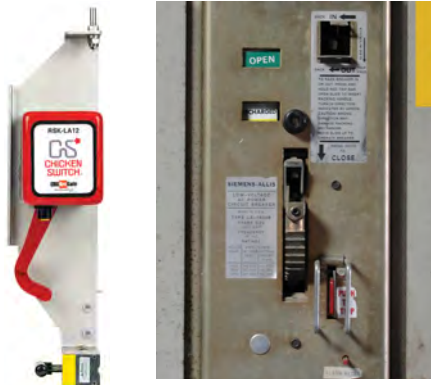

# RSK-MBSW1

FOR USE WITH:

**General Electric  
Control Switch**

## SPECIFICATIONS

**OPERATION:** Control Switch Operator

**WEIGHT:** 6.5 lbs.

**DIMENSIONS:**\* 6.3" x 5.9" x 7.6"

**COMPATIBLE WITH:** Magne-Blast Raise/Lower Toggle Switches

**BATTERY/POWER SOURCE:** Handheld Controller/  
Milwaukee M18 REDLITHIUM Ion Battery Pack



# RSK-MDS30

FOR USE WITH:

**Cutler-Hammer/Eaton  
Insulated Case Circuit Breaker**

## SPECIFICATIONS

**OPERATION:** Push-Button Close/Trip Operator

**WEIGHT:** 4.7 lbs.

**DIMENSIONS:**\* 17.8" x 9.5" x 6.5"

**COMPATIBLE WITH:** Magnum DS, SB (Door Closed, 800-4000 A)

**BATTERY/POWER SOURCE:** AA Batteries



\*All unit measurements are L x W x H

# RSK-NT20

FOR USE WITH:

**Merlin Gerin/Square D  
Insulated Case Circuit Breaker**

## SPECIFICATIONS

**OPERATION:** Push-Button Close/Trip Operator

**WEIGHT:** 4.6 lbs.

**DIMENSIONS:**\* 17.5" x 7.8" x 6.8"

**COMPATIBLE WITH:** Masterpact NT - All

**BATTERY/POWER SOURCE:** AA Batteries



# RSK-NW20

FOR USE WITH:

**Merlin Gerin/Square D  
Insulated Case Circuit Breaker**

## SPECIFICATIONS

**OPERATION:** Push-Button Close/Trip Operator

**WEIGHT:** 5.3 lbs.

**DIMENSIONS:**\* 18.0" x 8.0" x 7.8"

**COMPATIBLE WITH:** Masterpact NW - All

**BATTERY/POWER SOURCE:** AA Batteries



# RSK-P11W

FOR USE WITH:

**Square D Molded Case  
Circuit Breaker**

## SPECIFICATIONS

**OPERATION:** On/Off Rotating Handle Operator

**WEIGHT:** 13.0 lbs.

**DIMENSIONS:**\* 15.3" x 14.2" x 8.4"

**COMPATIBLE WITH:** I-Line MCCB - P Frame  
(600-2500 A, Flush Mounted, includes PA, PH,  
PY, PC, PI, PE, PX)

**BATTERY/POWER SOURCE:** Handheld  
Controller/Milwaukee M18 REDLITHIUM Ion  
Battery Pack



Cabled version also available.

\*All unit measurements are L x W x H

# RSK-PB16

FOR USE WITH:  
**Various Single Push-Buttons**

## SPECIFICATIONS

**OPERATION:** Single Function Push-Button Operator

**WEIGHT:** 2.7 lbs.

**DIMENSIONS:**\* 8.0" x 2.5" x 4.5"

**COMPATIBLE WITH:** Miscellaneous Single Push-Buttons

**BATTERY/POWER SOURCE:**  
AA Batteries



# RSK-RL12

FOR USE WITH:  
**Siemens-Allis/Siemens Air Circuit Breaker**

## SPECIFICATIONS

**OPERATION:** Push-Button Close/Trip Operator

**WEIGHT:** 6.5 lbs.

**DIMENSIONS:**\* 11.3" x 5.5" x 5.6"

**COMPATIBLE WITH:** Type RL, RLE, RLF, 3200-5000 A (includes RL, RLE, RLF - 3200, 4000, 5000)

**BATTERY/POWER SOURCE:**  
AA Batteries



# RSK-SACE1

FOR USE WITH:  
**ABB/SACE Air Circuit Breaker**

## SPECIFICATIONS

**OPERATION:** Push-Button Close/Trip Operator

**WEIGHT:** 1.1 lbs.

**DIMENSIONS:**\* 4.5" x 3.0" x 5.0"

**COMPATIBLE WITH:** Type E3S-A

**BATTERY/POWER SOURCE:** AA Batteries



\*All unit measurements are L x W x H

# RSK-SACE2

FOR USE WITH:  
**ABB/SACE**  
**Air Circuit Breaker**

## SPECIFICATIONS

**OPERATION:** Push-Button Close/Trip Operator  
**WEIGHT:** 1.5 lbs.  
**DIMENSIONS:**\* 3.8" x 3.3" x 4.5"  
**COMPATIBLE WITH:** Type S 1600  
**BATTERY/POWER SOURCE:** AA Batteries



# RSK-SBH2

FOR USE WITH:  
**Siemens**  
**Insulated Case Circuit Breaker**

## SPECIFICATIONS

**OPERATION:** Push-Button Close/Trip Operator  
**WEIGHT:** 4.4 lbs.  
**DIMENSIONS:**\* 13.0" x 8.0" x 7.0"  
**COMPATIBLE WITH:** SB, SBA, SBS (includes all; Trip Button Lower Right, Close Button Upper Left)  
**BATTERY/POWER SOURCE:** AA Batteries

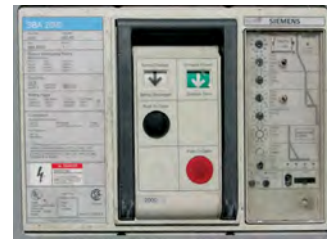

# RSK-SDL6C

FOR USE WITH:  
**Schneider Electric/Square D**  
**Motor Control Center**

## SPECIFICATIONS

**OPERATION:** On/Off MCC Handle Operator  
**WEIGHT:** 8.5 lbs.  
**DIMENSIONS:**\* 9.9" x 5.8" x 6.3"  
**COMPATIBLE WITH:** Model 6 MCC with 4.0" Handles (Model Year 2006 and Newer). Also Compatible with Optional Closed-Door Racking Feature.  
**BATTERY/POWER SOURCE:** Handheld Controller/Milwaukee M18 REDLITHIUM Ion Battery Pack



\*All unit measurements are L x W x H

# RSK-SDL6W

FOR USE WITH:

**Schneider Electric/Square D  
Motor Control Center**

## SPECIFICATIONS

**OPERATION:** On/Off MCC Handle Operator

**WEIGHT:** 8.5 lbs.

**DIMENSIONS:**\* 9.9" x 5.8" x 6.3"

**COMPATIBLE WITH:** Model 6 MCC Legacy with 4.5" Handles (Model Year Pre-2006)

**BATTERY/POWER SOURCE:** Handheld Controller/Milwaukee M18 REDLITHIUM Ion Battery Pack



Cabled version also available.

# RSK-SE06

FOR USE WITH:

**Square D  
Insulated Case Circuit Breaker**

## SPECIFICATIONS

**OPERATION:** Push-Button Close/Trip Operator

**WEIGHT:** 4.3 lbs.

**DIMENSIONS:**\* 17.5" x 9.5" x 7.3"

**COMPATIBLE WITH:** SE Series - All

**BATTERY/POWER SOURCE:** AA Batteries



# RSK-SPB1

FOR USE WITH:

**Westinghouse/Cutler-Hammer/  
Eaton Insulated Case Circuit Breaker**

## SPECIFICATIONS

**OPERATION:** Push-Button Close/Trip Operator

**WEIGHT:** 3.7 lbs.

**DIMENSIONS:**\* 16.3" x 4.8" x 7.3"

**COMPATIBLE WITH:** Type SPB Systems Pow-R Breaker: 250-1600 A (includes SPB-50, SPB-65, SPB-100, SPB-150)

**BATTERY/POWER SOURCE:** AA Batteries



\*All unit measurements are L x W x H

# RSK-SPB2

FOR USE WITH:

**Westinghouse/Cutler-Hammer/Eaton  
Insulated Case Circuit Breaker**

## SPECIFICATIONS

**OPERATION:** Push-Button Close/Trip Operator

**WEIGHT:** 3.9 lbs.

**DIMENSIONS:**\* 18.4" x 4.8" x 6.8"

**COMPATIBLE WITH:** Type SPB Systems  
Pow-R Breaker: 2500-4000 A (includes  
SPB-50, SPB-65, SPB-100, SPB-150)

**BATTERY/POWER SOURCE:** AA Batteries

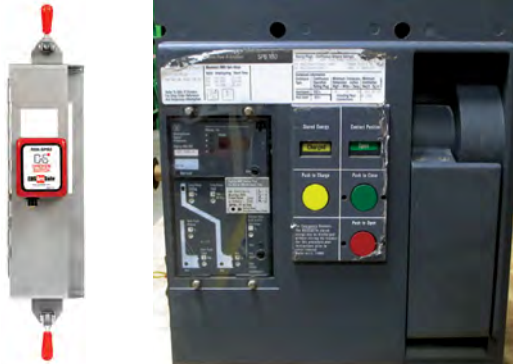

# RSK-WAV21

FOR USE WITH:

**General Electric  
Air Circuit Breaker**

## SPECIFICATIONS

**OPERATION:** Push-Button Close/Trip Operator

**WEIGHT:** 5.1 lbs.

**DIMENSIONS:**\* 16.9" x 6.5" x 7.0"

**COMPATIBLE WITH:** WavePro,  
800-2000 A (WPS, WPH, WPX  
- 08, 16, 20) & EntelliGuard, 800-  
2000 A (EGS, EGH, EGX - 08, 16,  
20)

**BATTERY/POWER SOURCE:**  
AA Batteries



# RSK-WL01

FOR USE WITH:

**Siemens  
Air Circuit Breaker**

## SPECIFICATIONS

**OPERATION:** Push-Button Close/Trip Operator

**WEIGHT:** 5.4 lbs.

**DIMENSIONS:**\* 17.8" x 6.9" x 6.8"

**COMPATIBLE WITH:** Type WL, 800-6000 A  
(includes WLS, WLL, WLC)

**BATTERY/POWER SOURCE:** AA Batteries



\*All unit measurements are L x W x H

# RSK-WL01R

FOR USE WITH:

**Siemens**  
**Air Circuit Breaker**

## SPECIFICATIONS

**OPERATION:** Push-Button Close/Trip Operator

**WEIGHT:** 5.0 lbs.

**DIMENSIONS:**\* 15.0" x 11.0" x 7.0"

**COMPATIBLE WITH:** Type WL, 800-6000 A (includes WLS, WLL, WLC) with Siemens Racking Rails

**BATTERY/POWER SOURCE:** AA Batteries



## G E T T H E M H O M E S A F E

The only way to avoid arc flash is to stay outside the danger zone by operating electrical equipment with remote racking and switching solutions from CBS ArcSafe.



RRS-1



RRS-2



RSK-CS01W



RRS-3 AKD-6



RSA-227

Remote racking and switching solutions from CBS ArcSafe allow technicians to operate electrical equipment from up to 300 feet away. Our best-in-class solutions reduce fatigue from manual racking, reduce the need for hot PPE gear, and give you the data you need for preventive and predictive maintenance operations. And thanks to our proprietary magnetic latching, our solutions protect the integrity of your equipment. **Call us to set up a demo** at your facility to keep your technicians safe from arc-flash incidents.

# Distance *is* Safety<sup>®</sup>

## Arc-Flash Safety Information

Every day in the U.S., as many as 10 injuries requiring hospitalization are attributed to arc-flash incidents. With the increase in awareness of the severity and frequency of electrical arc-flash hazards, the Occupational Safety and Health Administration (OSHA) realized the need to provide more direction and regulation to its general language.

The result is a final rule to 29 CFR 1910.269, the Electrical Power Generation, Transmission, and Distribution Standard. This is the first time OSHA has mandated specific arc-flash related requirements that go beyond general hazard awareness and also set mandatory compliance deadlines.

At **CBS ArcSafe**, the safety of our customers' electrical workers is our top priority. That's why we designed our remote racking systems to reduce the need for full-body arc-flash hazard suits. As the leader in the design and manufacture of various styles of remote operation equipment, **CBS ArcSafe** is dedicated to increasing arc-flash safety for electrical workers worldwide.



## Want a Demo? We'll Come to You!

**CBS ArcSafe** can bring a demonstration of our remote racking and switching equipment directly to your doorstep. We'll bring our fleet with gear, so you can see firsthand how our products protect technicians from arc-flash danger when they are installing or removing breakers.

Contact us at **877-4-SAFETY** or [info@CBSArcSafe.com](mailto:info@CBSArcSafe.com) to schedule a demo at your site.



# SMART PEOPLE TEST. UNLUCKY PEOPLE GET BURNED.

## DON'T BE BOTH.

Frequent electrical testing leads to higher uptime, but it also increases the danger of arc flash and arc blasts. **CBS ArcSafe's** remote racking and remote switching solutions reduce arc-flash dangers and technician fatigue during dangerous operations without modifying your switchgear.



## Distance *is* Safety®

### Remote Racking Solutions

- Remote racking solutions reduce the need for full-body arc-flash hazard suits by taking technicians outside the arc-flash boundary.
- No equipment modifications required.

### Remote Switching Solutions

- No modifications required due to magnetic latching.
- Remote switching solutions are available for virtually any style or piece of electrical equipment.

**CBS ArcSafe**  
A Group CBS Company

**(877)4-SAFETY (472-3389)**  
**CBSArcSafe.com**

# WHEN PASS/FAIL ISN'T ENOUGH

## THE WORLD'S ONLY PREDICTIVE VACUUM INTERRUPTER TEST SET

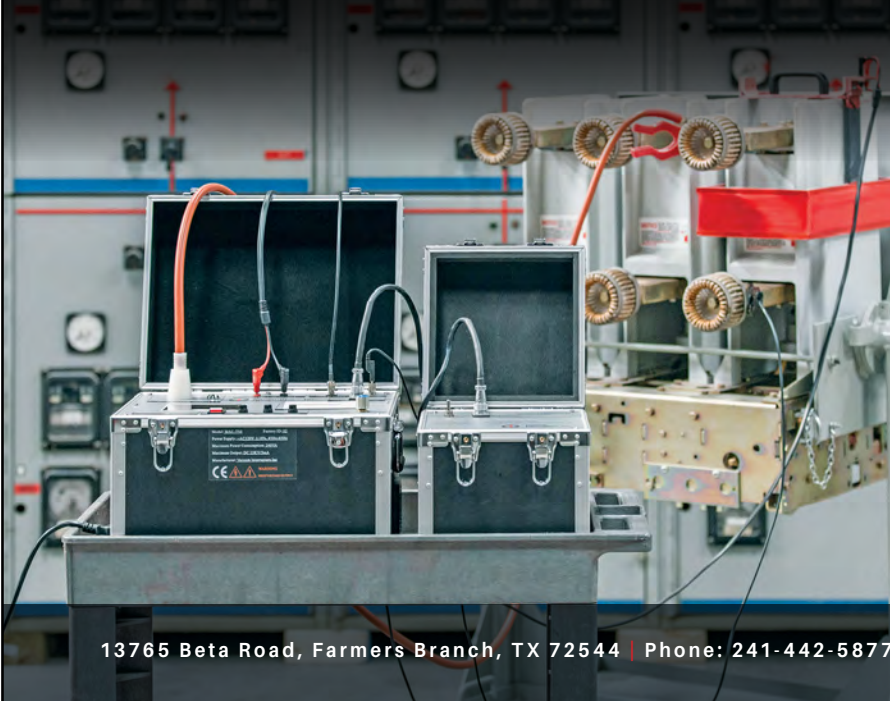

## MAC-TS4

- Industry's first portable vacuum interrupter test system capable of predicting remaining life
- World's first system capable of testing vacuum interrupters in both the shop and field
- Analysis based on same OEM leak-rate test performed at the factory
- System parameters based on measurements of thousands of vacuum interrupters

**VacuumInterruptersInc.com**  
Info@VacuumInterruptersInc.com



13765 Beta Road, Farmers Branch, TX 72544 | Phone: 241-442-5877





## GROUP CBS AFFILIATES

### Group CBS

GroupCBS.com  
Addison, TX — Ph: 972-250-2500

### Advanced Electrical & Motor Controls

AEAMC.com  
Irving, TX — Ph: 972-253-7783

### Arkansas Electrical Outlet

AEGlobal.com  
Forrest City, AR — Ph: 870-633-4997

### CBS ArcSafe

CBSArcSafe.com  
Denton, TX — Ph: 940-382-4411  
Charleston, WV — Ph: 304-965-9220

### CBS Nuclear Services

CBSNuclear.com  
Matthews, NC — Ph: 704-882-1875

### Carolina Precision Switchgear

CPSwitchgear.com  
Concord, NC — Ph: 704-596-4242

### Circuit Breaker Analyzer

CBAAnalyzer.com  
Addison, TX — Ph: 972-290-0074

### Circuit Breaker Sales & Repair

CBSalesAndRepair.com  
**HEADQUARTERS:**  
La Porte, TX — Ph: 281-479-4555

#### REGIONAL SERVICE SHOP:

Gonzales, LA — Ph: 225-673-2278

### Circuit Breaker Sales

CircuitBreaker.com  
**HEADQUARTERS:**  
Gainesville, TX — Ph: 940-665-4444

#### REGIONAL SERVICE SHOPS:

Chicago Service Shop  
Crown Point, IN — Ph: 219-213-2095

Denver Service Shop  
Denver, CO — Ph: 720-981-4580

Detroit Service Shop  
Livonia, MI — Ph: 734-357-8005

Lakeland Service Shop  
Lakeland, FL — Ph: 863-646-5099

Houston Service Shop  
La Porte, TX — Ph: 281-479-4555

Phoenix Service Shop  
Phoenix, AZ — Ph: 888-395-2021

Salt Lake Service Shop  
Salt Lake City, UT — Ph: 888-395-2021

Seattle Service Shop  
Seattle, WA — Ph: 888-395-2021

Vancouver Service Shop  
Vancouver, WA — Ph: 888-395-2021

### Circuit Breaker Sales NE

CircuitBreakerSalesNE.com  
**HEADQUARTERS:**  
Seymour, CT — Ph: 203-888-7500  
**REGIONAL SERVICE SHOPS:**  
Johnstown, PA — Ph: 203-888-7500  
Boston, MA — Ph: 781-438-7770

### National Circuit Breaker

NationalCircuitBreaker.com  
Santa Fe Springs, CA — Ph: 800-945-0065

### Solid State Exchange & Repair

SolidStateRepair.com  
Denton, TX — Ph: 877-TRIP-FIX

### Switchgear Power Solutions

SwitchgearPowerSolutions.com  
Sheboygan Falls, WI — Ph: 920-234-2500

### Vacuum Interrupters

VacuumInterruptersInc.com  
Farmers Branch, TX — Ph: 214-442-5877

### CBS Field Services

CBSFieldServices.com  
**HEADQUARTERS:**  
Phoenix, AZ — Ph: 888-395-2021

#### REGIONAL SERVICE CENTERS:

CBS Field Services Detroit  
Detroit, MI — Ph: 810-720-2280

CBS Field Services Lakeland  
Lakeland, FL — Ph: 800-232-5809

CBS Field Services Nashville  
Nashville, TN — Ph: 615-669-4348

CBS Field Services Salt Lake City  
Salt Lake City, UT — Ph: 888-395-2021

CBS Field Services Seattle  
Sumner, WA — Ph: 888-395-2021

CBS Field Services Vancouver  
Vancouver, WA — Ph: 888-395-2021

### Group CBS UK/Europe

GroupCBSEurope.co.uk  
Milton Keynes, Buckinghamshire, England — Ph: +44 0 7770 500 577

### Premier Power Maintenance

PremierPower.us  
**HEADQUARTERS:**  
Indianapolis, IN — Ph: 317-879-0660

#### REGIONAL SERVICE CENTERS:

Central Region  
Louisville, KY — Ph: 502-265-8634

Eastern Region  
Ashland, KY — Ph: 606-929-5969

Northern Region  
Brighton, MI — Ph: 517-230-6620

Northwestern Region  
Roseville, MN — Ph: 612-499-9166

Southeastern Region  
Punta Gorda, FL — Ph: 317-879-0660

Southern Region  
Decatur, AL — Ph: 256-355-1444